

TECHNICAL SPECIFICATIONS

VIDEO	
Format	HDMI2.0
Input Interface	(8) HDMI 19-pin
Output Interface	(1) HDMI 19-pin
Resolution	Up to 4K (3840 x 2160 @ 30 Hz); Up to 1920 x 1080 @ 60Hz (DVI-D)
DDC	5 volts p-p (TTL)
Input Equalization	Automatic
Input Cable Length	Up to 20 ft
Output Cable Length	Up to 20 ft
USB	
Signal Type	USB 2.0, 1.1, and 1.0 w/ internal hub
Input Interface	(8) USB Type B
Output Interface	(2) USB 1.1 Type A for KVM Devices; (2) USB 2.0 Type A Transparent
CONTROL	
Front Panel	Push Buttons with LED Indicators
RS-232	Via Control @ 115200 bps
Hot Keys	Via Keyboard
OSD	Via KM arrow keys
OTHER	
Power	External 100-240 VAC/ 12VDC3A @ 24W
Dimensions	17.0" W x 1.76" H x 8.69" D
Weight	6.3 lbs
Approvals	UL, CE, ROHS Compliant
Operating Temp.	32 to +104 °F (0 to +40 °C)
Storage Temp.	-4 to 140 °F (-20 to +60 °C)
Humidity	Up to 80% (no condensation)
Emulation	Keyboard and Mouse

WHAT'S IN THE BOX

PART NO.	QTY	DESCRIPTION
SM-UHO-8P	1	SH 8-Port HDMI KVM Switch with USB 2.0 Support and OSD
PS12VDC3A	1	12-VDC, 3-A power adapter with center-pin positive polarity.
	1	Quick Start Guide

NOTICE

The information contained in this document is subject to change without notice. iPGARD makes no warranty of any kind with regard to this material, including but not limited to, implied warranties of merchantability and fitness for a particular purpose. iPGARD will not be liable for errors contained herein, or for incidental or consequential damages in connection with the furnishing, performance, or use of this material. No part of this document may be photocopied, reproduced, or translated into another language without the prior written consent from iPGARD, Inc.

20170518



DESIGNED
AND MADE
IN THE USA

Toll Free: (888)-994-7427

Phone: (702) 800-0005

Fax: (702)-441-5590

WWW.IPGARD.COM

Smart-AM

SM-UHO-8P



**8-Port HDMI KVM Switch
with USB 2.0 Sharing and OSD**

Quick Start Guide

A full manual can be downloaded from
www.ipgard.com/documentation/

SYSTEM CONTROL

There are three ways to control the KVM Switch: Keyboard HotKeys, RS-232 Serial Commands, and Front Panel Buttons. The settings for the serial connection are as follows: Baud rate: **115200**; Data Bits: **8**; Parity: **None**; Stop Bits: **1**; Flow Control: **None**.

The following commands can be used:

Command	Hotkey	RS-232
Switch KVM	[CT][CT][#]<CR>	//m[#]<CR>
Audio Only	[CT][CT]a[#]<CR>	//a[#]<CR>
KM Only	[CT][CT]c[#]<CR>	//c[#]<CR>
USB Only	[CT][CT]u[#]<CR>	//u[#]<CR>
Learn EDID	[CT][CT]e[#]<CR>	//e[#]<CR>
Trigger Hotplug	[CT][CT]h<CR>	//h<CR>
Restore Factory Defaults	[CT][CT]f<CR>	//f<CR>
Reset Software	[CT][CT]r	//r<CR>
Get Port Status	N/A	//??<CR>

Chart Key

[CT] = Ctrl
 <CR> = Carriage Return (Enter Key)
 [HK] = Current Hot Key Trigger

CUSTOM HOTKEY TRIGGERS

Users are able to customize the keys that trigger Hotkeys. The following keys are allowed: CT (Left/Right), Alt, Shift (Left/Right), Caps Lock, Scroll Lock, F1-F12

Change HK Trigger

HK + HK + X + desired hotkey

View Current HK Trigger

Use the RS-232 command: //??<CR>

Reset HK Trigger

Run "Restore Factory Defaults" command.

Default HotKey Trigger

CT (Left)

HARDWARE INSTALLATION

1. Ensure that power is turned off or disconnected from the unit and the computers.
2. Use HDMI cables to connect the HDMI output ports from each computer to the corresponding HDMI IN ports of the unit.
3. Use a USB cable (Type-A to Type-B) to connect a USB port on each computer to the respective USB ports of the unit.
4. Optionally, connect a stereo audio cable (3.5 mm to 3.5 mm) to connect the audio output of the computer(s) to the audio in ports of the unit.
5. Connect monitor(s) to the HDMI out console ports of the unit using HDMI cable(s).
6. Connect a USB keyboard and mouse in the two USB console ports.
7. Optionally, connect stereo speakers to the audio out port of the unit.
8. Optionally use included 3.5mm to DB9 Cable and connect with a standard RS-232 Cable (not included) to connect to a PC for Serial Control
9. Finally, power on the secure KVM switch by connecting a 12-VDC power supply to the power connector, and then turn on all the computers.

Note: You can connect one monitor to the single-head KVM switch. The computer connected to port 1 will always be selected by default after power up.

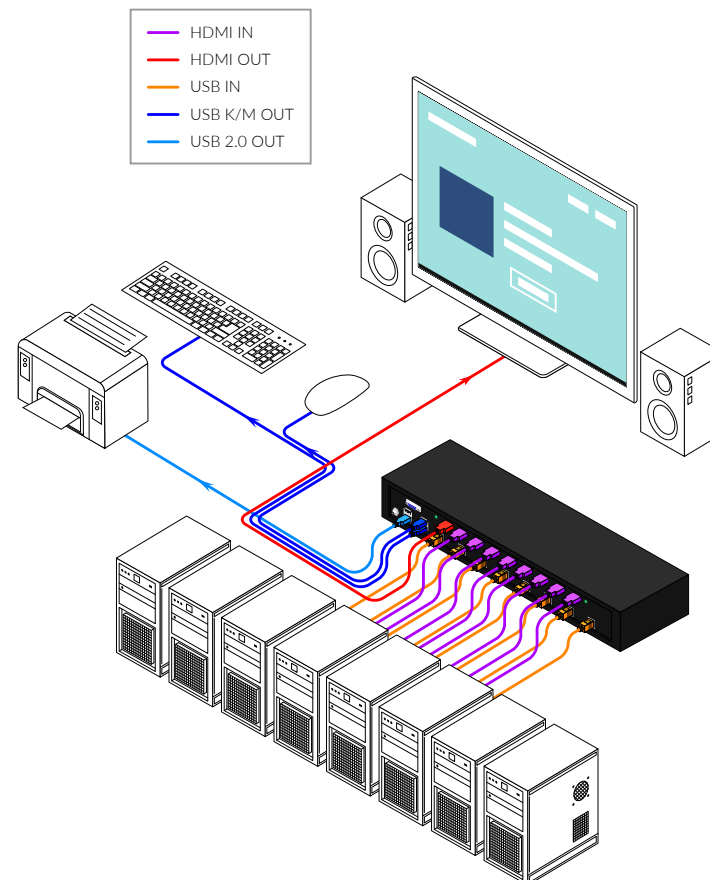

OSD Menu

Important: when in OSD menu, all keyboard and mouse functionality will be blocked from the computer and only used for the OSD commands. After exiting the OSD menu, all keyboard and mouse functionality will be restored.

Keyboard hotkeys for OSD:

Command	Hotkey
OSD ON/OFF	[CT][CT]o<CR>
OSD Up	↑ (UP arrow)
OSD Down	↓ (DOWN arrow)
OSD Left	← (LEFT arrow)
OSD Right	→ (RIGHT arrow)
OSD Enter	[ENTER]
OSD Esc	[ESC]