



Contents



Introduction

Welcome	2
Cable distance rules.....	2
Supplied items	3
Optional extras.....	4

Installation

Connections	5
Mounting the modules – desk or rack	5
Connections at the local module	6
Optional power connection.....	7
Connections at the remote module	8
Power connection	10

Operation

General use	11
Video display (EDID) information	11
HDMI 1.3a operation	11
Power and activity indicators	11

Further information

Troubleshooting.....	12
Getting assistance	13
Warranty	14
Safety information	14
Radio frequency energy	14

Introduction

WELCOME

Thank you for choosing the AdderLink X-DVIPRO or X-DVIPRO-MS2 extenders. These compact modules provide the quickest way to extend high quality single link DVI digital video plus USB keyboard, mouse and stereo audio (plus on MS2 variants, a second digital video channel and audio channel) with an additional two USB peripherals up to 50 meters away from your computer.

Thanks to our long involvement and investment in extender technology we have succeeded in overcoming the numerous problems associated with extending digital video signals. Using our proprietary transmission techniques the X-DVIPRO and X-DVIPRO-MS2 modules can reliably transfer video rates up to 165 Mpixels per second. This is in addition to two USB channels for keyboard and mouse, plus stereo audio - all via the same single length of CAT6a or CAT7 shielded twisted pair cabling.

The AdderLink X-DVIPRO and X-DVIPRO-MS2 extender modules have been designed to be quick to install and totally transparent in operation.

Cable type and distance rules

- Cable screening is paramount. The best cable screening specifications for digital KVM extension are: S/FTP, S/STP or PiMF.
- Extension distances up to 50m are supported with single uninterrupted runs of recommended cable (Adder CAT7 patch cable) at full resolution.
- Extensions of 50m may be achieved with single uninterrupted runs of shielded CAT6a bulk/trunk (not patch) cable at full resolution.
- Adder does not recommend CAT5e cables for use with this product.
- Overall cable runs must be reduced by 5m for each additional cable coupling.
- Run specifications may be increased by 10m when using resolutions of 1280 x 1024 or lower.
- All patch cables should be as short as possible and should be no longer than 2m.
- It is recommended that Adder CAT7 patch cables are used for maximum performance.

Recommended 50m link cable for best results: Adder part number - VSCAT7-50

X-DVIPRO link with direct cable connection

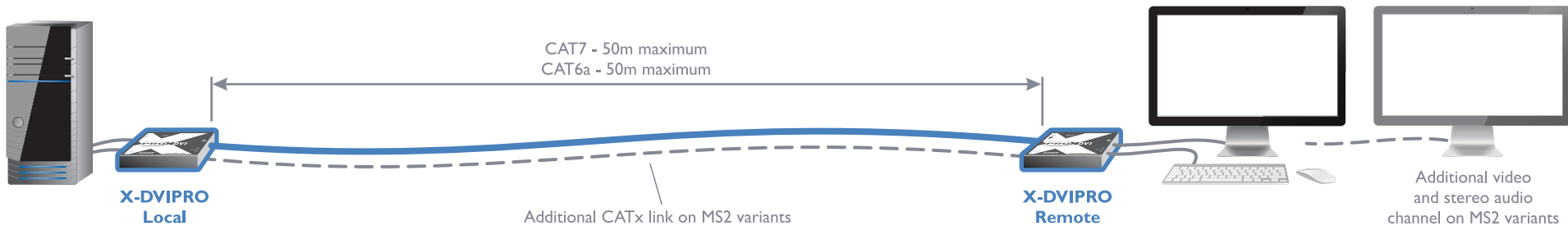

X-DVIPRO link with cable and patch panel connections

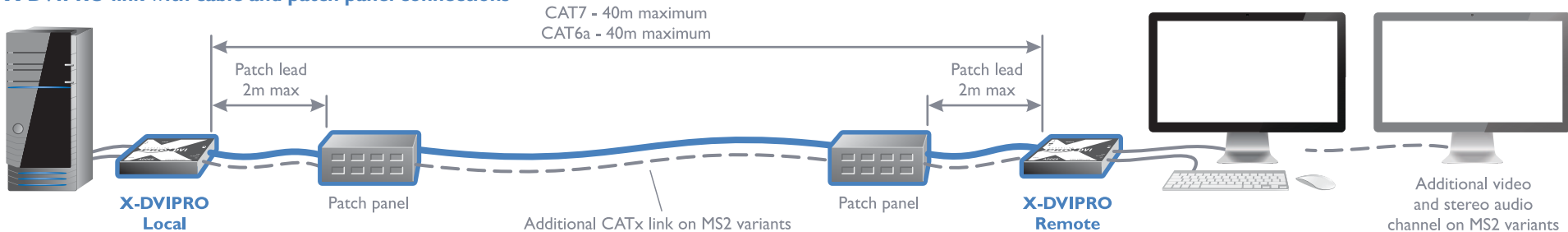

SUPPLIED ITEMS

AdderLink X-DVIPRO standard modules

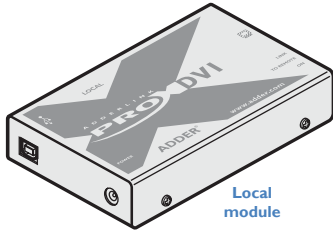

Local module

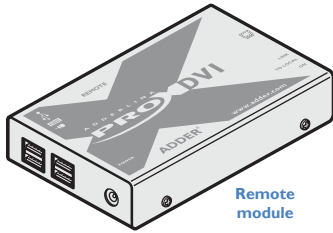

Remote module

AdderLink X-DVIPRO-MS2 dual modules

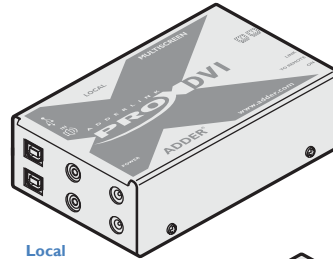

Local module

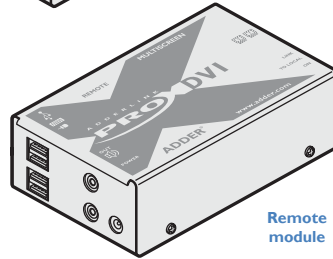

Remote module

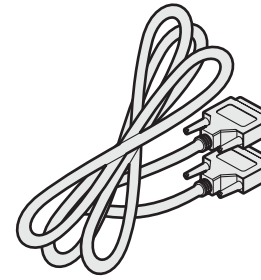

Additional video cable DVI-D to DVI-D

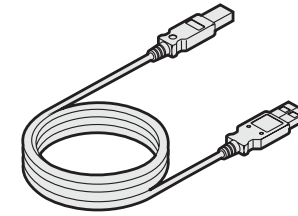

Additional USB cable 2m (type A to B)

The standard and MS2-dual variant packages include the respective items shown above, plus the following:

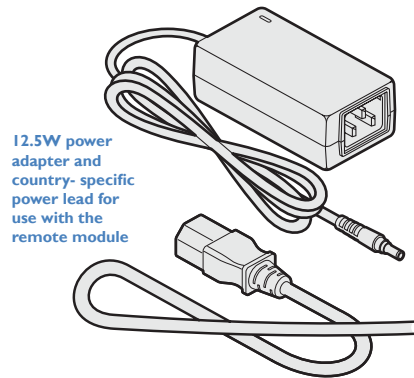

12.5W power adapter and country-specific power lead for use with the remote module

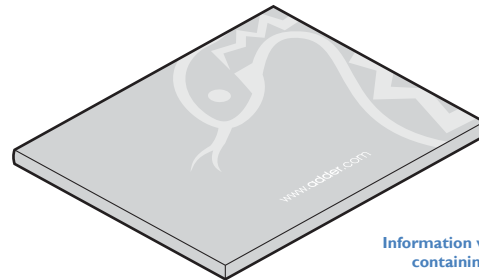

Information wallet containing:
Four self-adhesive rubber feet
Safety document

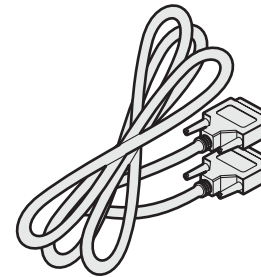

Video cable DVI-D to DVI-D

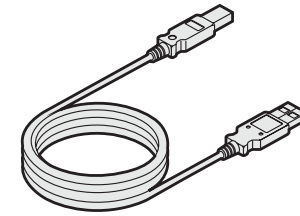

USB cable 2m (type A to B)

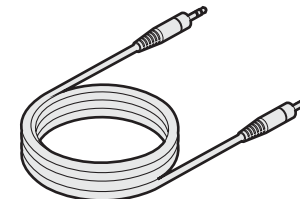

3.5mm jack to jack stereo audio cable

OPTIONAL EXTRAS

Additional power adapter and country-specific power lead for X-DVIPRO local module, if powering via the USB port is not possible. In such cases, two power adapters are required for X-DVIPRO-MS2 local modules.
Part number: PSU-IEC-5VDC-2.5A

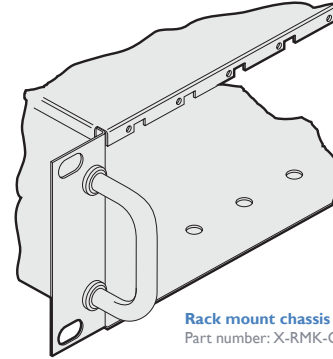
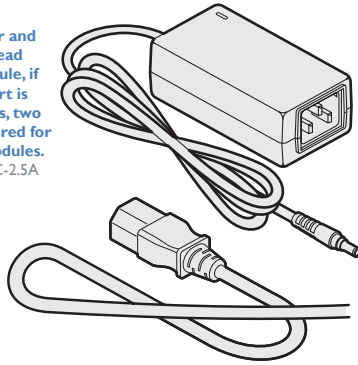

Rack mount chassis
Part number: X-RMK-CHASSIS

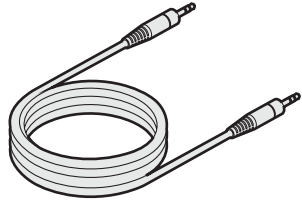

Extra 3.5mm jack to jack stereo audio cable
Part number:VSC22

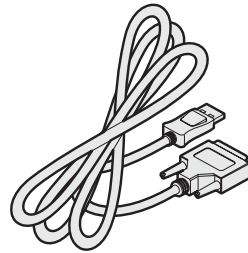

HDMI to DVI-D video cable
Part number:VSCD11



Rack mount kit for X-DVIPRO
Part number: X-RMK-FASCIA

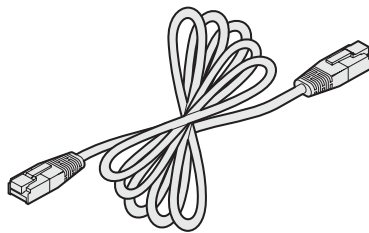

50 meter CAT7 link cable
Part number:VSCAT7-50

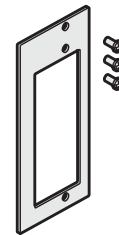

Rack mount kit for X-DVIPRO-MS2
Part number: X-RMK-FASCIA-DUAL

CONNECTIONS

Installation of the X-DVIPRO and X-DVIPRO-MS2 modules is straightforward and requires minimal configuration in most cases.

- [Connections at the local module](#)
- [Connections at the remote module](#)

Note: After all connections are made, power up the monitor and the REMOTE module first (followed by the LOCAL module, if using the X-DVIPRO-MS2 variant) and then switch on the computer.

Mounting the modules – desk or rack

The X-DVIPRO and X-DVIPRO-MS2 modules can be situated on a desk or alternatively, for larger installations, mounted within an optional rack mount chassis.

Desk mount

Apply the supplied self-adhesive rubber feet to the underside of the module.

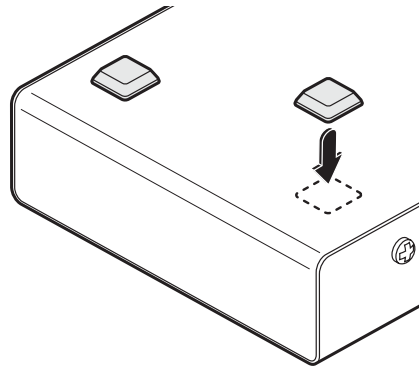

Rack mount

- 1 Place the rack securing plate (available as a separate kit) onto the front of the module and secure it with the two countersunk screws.
- 2 Orient the X-DVIPRO (or X-DVIPRO-MS2) module on its side so that its labeled face is the correct way up.
- 3 Slide the module into the required rack position. The rectangular cut-out in the front upper lip of the rack allows the two screws on the module's upper edge to slide through.
- 4 The rack mount chassis has a series of holes in its floor that are spaced to accommodate the two screws on the module's lower edge. Ensure that the screws correctly locate into the two holes of the chosen slot. The rack securing plate on the module should now be flush with the front of the rack mount chassis.
- 5 Use the third (pan-head) screw, in the top hole of the rack securing plate to fasten the module to the rack.

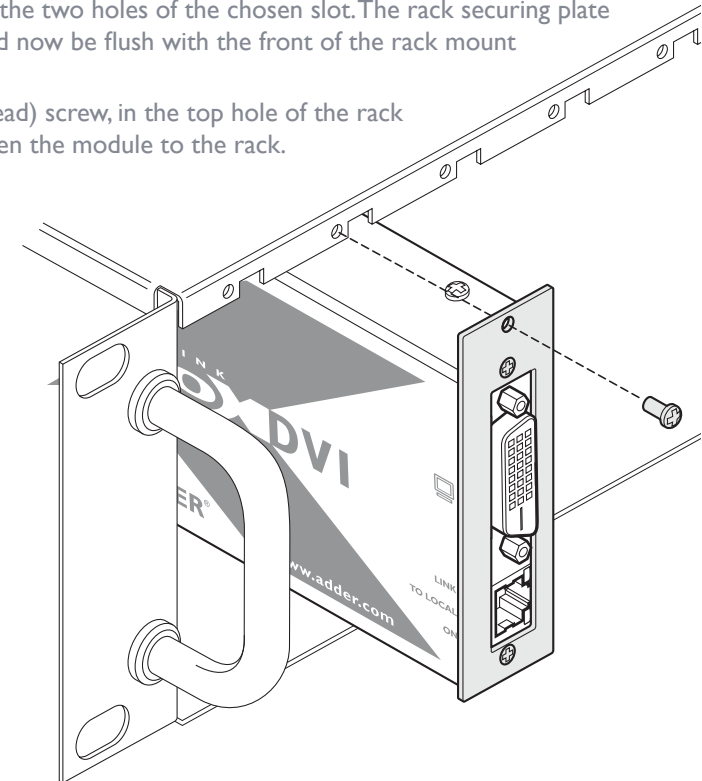

Connections at the local module

- 1 Where possible, ensure that power is disconnected from the computer system to be connected.
- 2 Use the supplied DVI-D link cable to connect the DVI input socket of the local module to the digital video output socket of the computer.

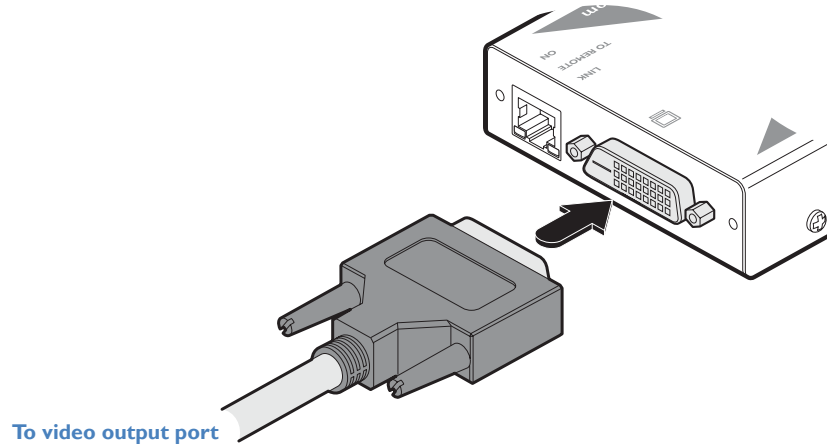

[MS2 variant only] Optionally attach a second video input from the computer system using the supplied DVI-D link cable.

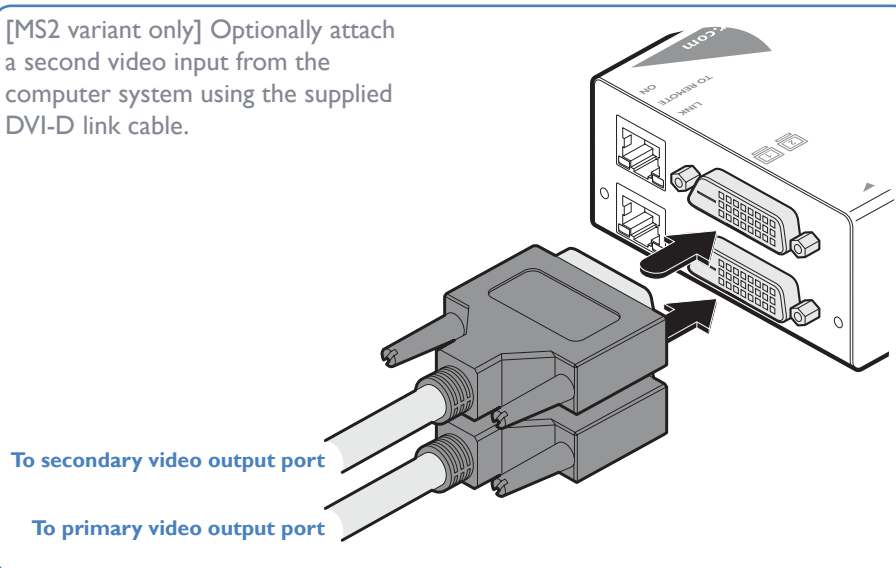

- 3 Use the supplied USB cable to link the USB socket of the local module to a vacant USB socket on the computer.

Note: Do not use USB cables longer than 3 meters to connect the local module to the computer.

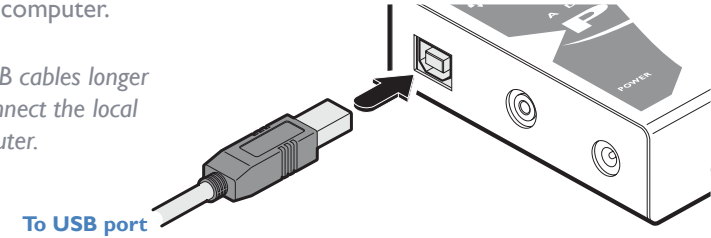

[MS2 variant only] Optionally attach a second USB connection from the computer system using the supplied USB cable.

Feeds the UPPER two USB sockets on the remote unit

To second USB port

To first USB port

Feeds the LOWER two USB sockets on the remote unit

- 4 Optionally use the supplied audio cable to link the audio port to the stereo audio output of the computer.

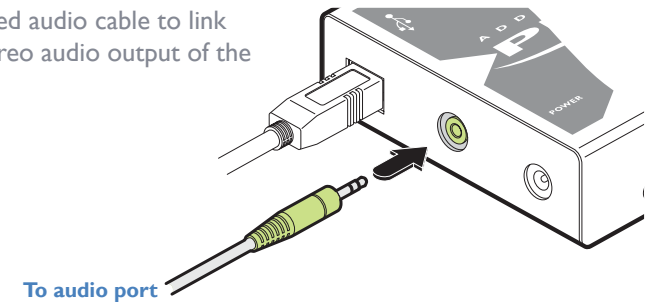

[MS2 variant only] Optionally link a second stereo audio source to the module.

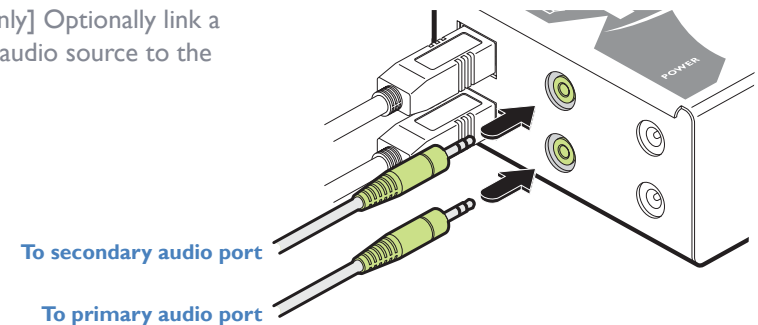

- 5 Connect the link cable (see page 2 for cable advice) to the local module socket labeled **TO REMOTE**.

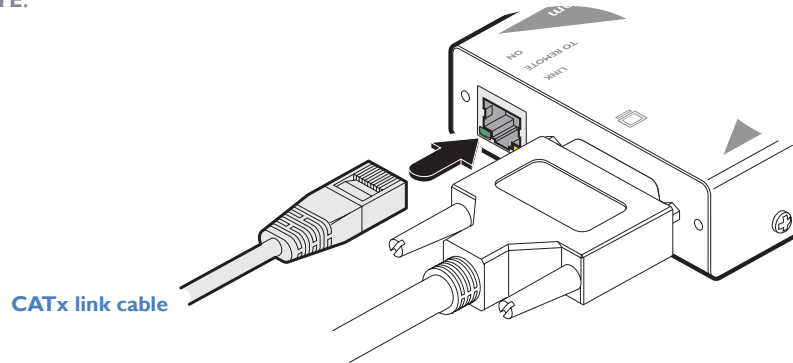

[MS2 variant only] Attach a second category 6a or 7 link cable (up to 50 meters in length) to the upper socket on the MS2 local module.

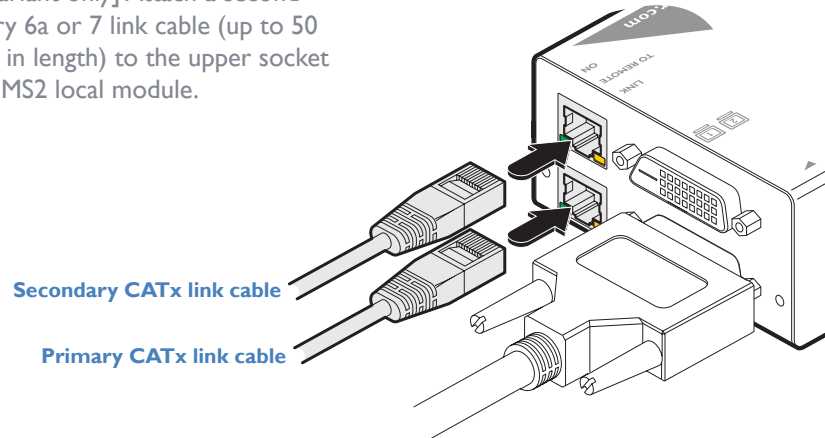

Optional power connection

The X-DVIPRO local module is designed to derive its power from the host computer via the USB connection (two USB connections in the case of the MS version). If this is not possible, then you will need to use one or two optional Adder power adapter(s).

Optionally for X-DVIPRO and X-DVIPRO-MS2 units:

- 1 Connect the output lead of the optional power adapter(s) to the socket(s) labeled **POWER** on the local module.

X-DVIPRO: Use an optional power adapter only if powering from the host (via USB) is not possible.

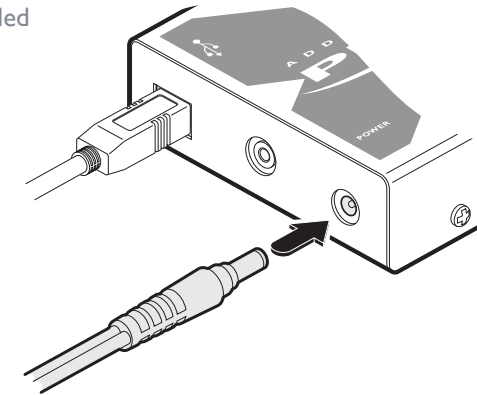

Note: After all connections are made, power up the monitor and the REMOTE module first (followed by the LOCAL module, if using the X-DVIPRO-MS2 variant with power adapters) and then switch on the computer.

X-DVIPRO-MS2: Use two optional power adapters if powering from the host (via dual USB connections) is not possible.

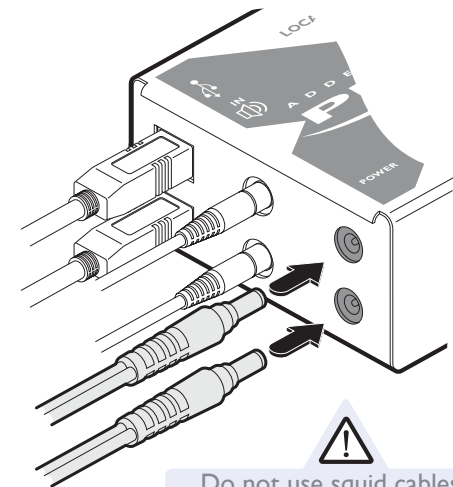

Do not use squid cables or power splitters. Two separate power adapters must be used.

- 2 Insert the IEC connector of the separate power lead(s) into the corresponding socket(s) of the power adapter(s). Connect the other end of the power lead(s) to one/two nearby mains socket(s).

Connections at the remote module

- 1 Place the remote module adjacent to the user location.
- 2 Connect the supplied DVI-D lead from the video monitor to the DVI output socket of the remote module.

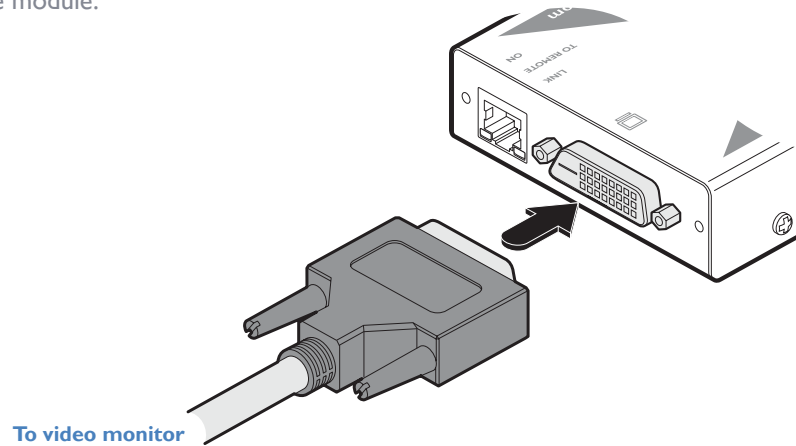

[MS2 variant only] Optionally attach a second DVI video monitor using the supplied additional video cable.

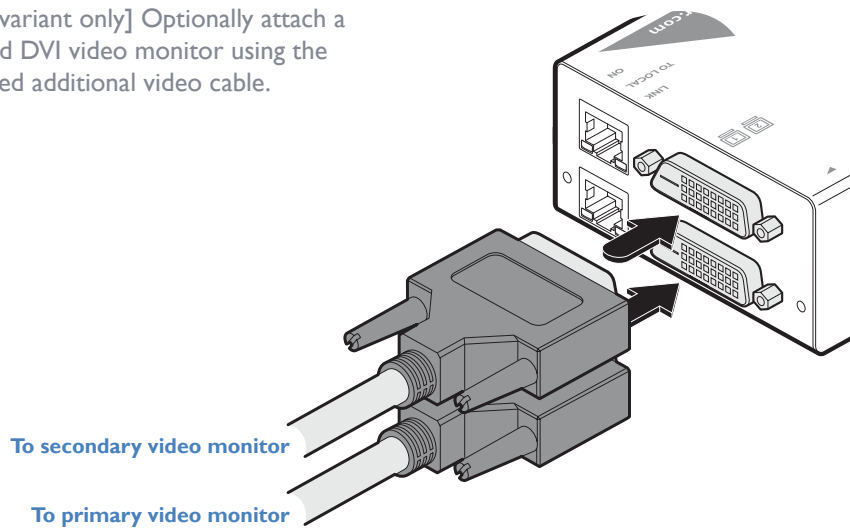

- 3 Connect the leads from the keyboard and mouse to the two USB sockets on the remote module.

Note: On the single head variant, it is not important which of the four sockets are used.

To keyboard, mouse and other USB peripherals

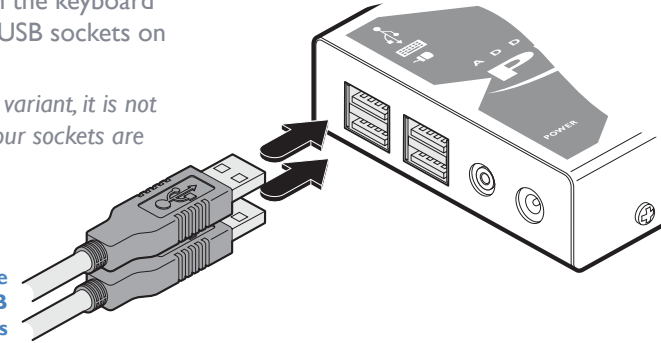

IMPORTANT: The total current that may be drawn from the USB ports is 1.2A, which should be sufficient for a keyboard, mouse (no more than 100mA each) and any two other devices (500mA maximum each). If more power for USB devices is required, please use a powered USB hub.

[MS2 variant] Connect the leads from the keyboard and mouse to the two USB sockets on the remote module.

Fed from the UPPER USB socket on the local unit

To keyboard, mouse and other USB peripherals

Fed from the LOWER USB socket on the local unit

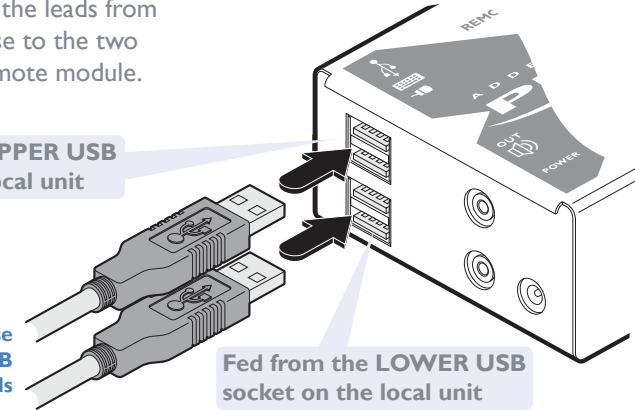

continued

4 Optionally connect a set of stereo speakers to the module.

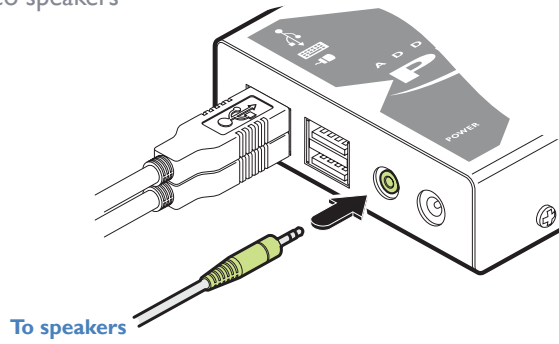

[MS2 variant only] Optionally connect a second set of stereo speakers to the module.

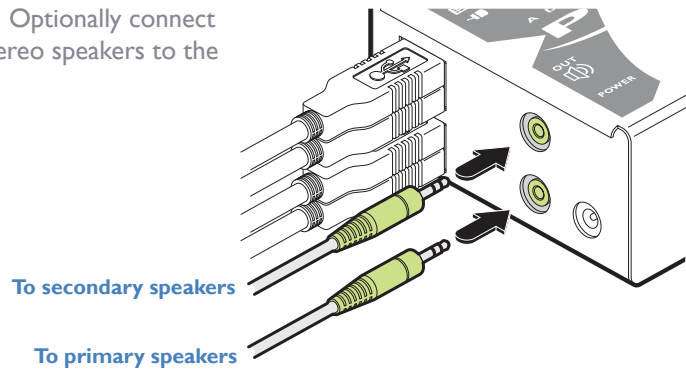

5 Connect the link cable (see page 2 for cable advice) to the remote module socket labeled **TO LOCAL**.

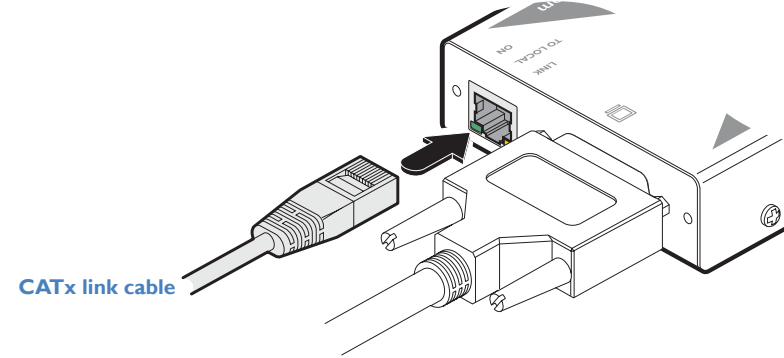

[MS2 variant only] Attach a second category 6a or 7 link cable (up to 50 meters in length) to the upper socket on the MS2 remote module.

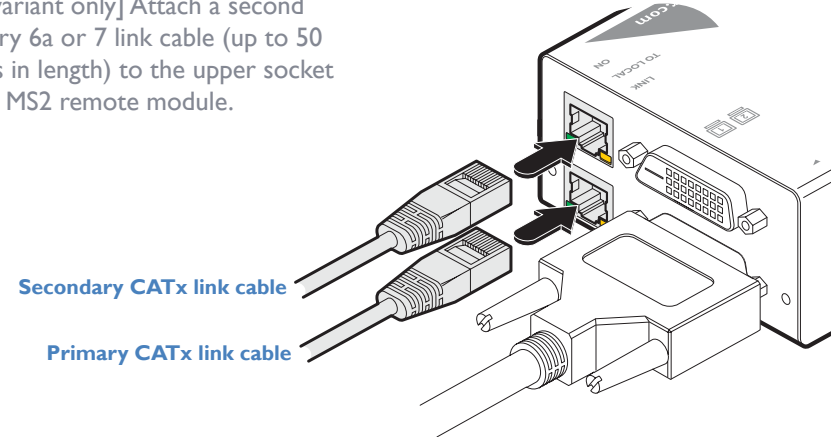

Power connection

- 1 Connect the output lead of the supplied power adapter to the socket labeled **POWER** on the remote module.

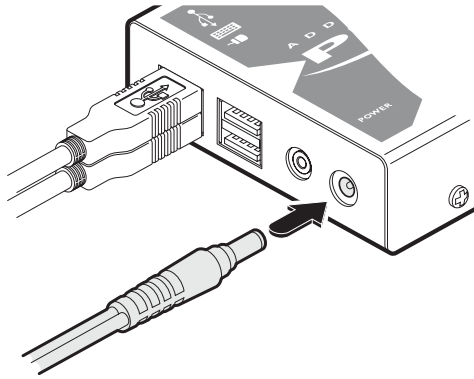

X-DVIPRO: Output lead from the power adapter

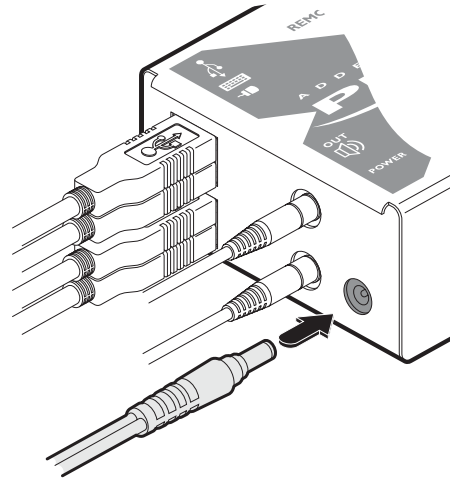

X-DVIPRO-MS2: Output lead from the power adapter

- 2 Insert the IEC connector of the separate power lead into the corresponding socket of the power adapter. Connect the other end of the power lead to a nearby mains socket.
- 3 After all connections are made, power up the monitor and remote module (then the local module, if using the X-DVIPRO-MS2 variant) and finally switch on the computer.

GENERAL USE

In use, the X-DVIPRO and X-DVIPRO-MS2 modules should be transparent - the system and its peripherals should operate exactly as normal, the only difference being that they are now up to 50 meters apart.

Video display (EDID) information

Extended Display Identification Data (or EDID) is an industry standard scheme which allows video displays to declare their capabilities to the computer's video adapter circuitry, allowing the latter to optimize their outputs accordingly. Since the widespread adoption of the scheme, video adapters have become increasingly dependent on receiving relevant EDID information during start-up, before they will output anything more than a rudimentary video signal.

Each time that the remote module is powered on, it attempts to read the EDID information from the connected DVI video monitor. If the attempt is successful, the information is transferred to the local module and stored within non-volatile memory. This information is then made available to the computer's video adapter when required.

On MS2 variants, EDID is handled independently for the two video connections, allowing completely different video display configurations on the two ports.

HDMI 1.3a operation

Using optional HDMI to DVI converter cables (Adder part number:VSCD11), the AdderLink X-DVIPRO-MS can support HDMI video and audio up to the 165MHz clock rate (1920 x 1080 at 60Hz, 24-bit color).

Eight channels of HDMI audio are supported with sample sizes of 16, 20 or 24-bits at 32kHz, 44.1kHz, 48kHz, 88.2kHz, 96kHz, 176.4kHz, or 192kHz (simultaneously with the jack audio).

Note: The High-bandwidth Digital Content Protection (HDCP) and Consumer Electronics Control (CEC) schemes are not supported.

Power and activity indicators

Each module provides two indicators to confirm power status and also feedback about the various input signals:

Local module

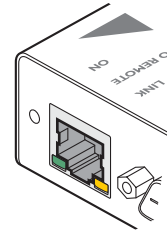

Green:

- On when power is present.

Yellow:

- On when a valid DVI video input signal is being received from the computer.
- Off when the CATx link cable is disconnected.

Note: On MS2 variants, the link ports are independent, so failure of one link does not affect the video or USB status of the other link.

Remote module

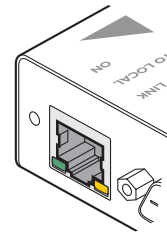

Green:

- On when power is present.

Yellow:

- On when a valid DVI video input signal is being received from the local module.
- Flashes regularly (twice per second) when no valid DVI video signal is being received from the local module.

Note: On MS2 variants, the link ports are independent, so failure of one link does not affect the video or USB status of the other link.

This chapter contains a variety of information, including the following:

- Troubleshooting - see right
- [Getting assistance](#)
- [Safety information](#)
- [Warranty](#)
- [Radio frequency energy statements](#)

TROUBLESHOOTING

If you experience problems when installing or using the X-DVIPRO/X-DVIPRO-MS2 modules, please check through this section for a possible solution. If your problem is not listed here and you cannot resolve the issue, then please refer to the [Getting assistance](#) section.

No video image is displayed on the remote monitor

- Check the yellow indicators on the local and remote modules while no keys are pressed on the keyboard and no mouse movements are being made - both indicators should be continually on when a valid video signal is present.

LOCAL: If the yellow indicator is giving a regular flash (twice per second), then the video feed to the local module is not valid. Try connecting a DVI monitor (preferably using the same DVI link cable as used with the local module) directly to the computer and check for a correct image.

REMOTE: If the yellow indicator is giving a regular flash (twice per second), then the video feed via the link cable is not valid. If the link cable is long, try using a short link cable temporarily to check for basic operation.

If the yellow indicators are off, then the link cable is not properly connected.

GETTING ASSISTANCE

If you are still experiencing problems after checking the information contained within this guide, then we provide a number of other solutions:

- **Online solutions and updates** – www.adder.com/support
Check the Support section of the adder.com website for the latest solutions and firmware updates.
- **Adder Forum** – forum.adder.com
Use our forum to access FAQs and discussions.
- **Technical support** – www.adder.com/contact-support-form
For technical support, use the contact form in the Support section of the adder.com website - your regional office will then get in contact with you.

SAFETY INFORMATION

- For use in dry, oil free indoor environments only.
- Do not use to link between buildings.
- Ensure that the twisted pair interconnect cable is installed in compliance with all applicable wiring regulations.
- Do not connect the CATx link interface (RJ45 style connector) to any other equipment, particularly network or telecommunications equipment.
- Warning – the power adapter contains live parts.
- No user serviceable parts are contained within the power adapter - do not dismantle.
- Plug the power adapter into an earthed socket outlet close to the unit that it is powering.
- Replace the power adapter with a manufacturer approved type only.
- Do not use the power adapter if the power adapter case becomes damaged, cracked or broken or if you suspect that it is not operating properly.
- If you use a power extension cord with the units, make sure the total ampere rating of the devices plugged into the extension cord do not exceed the cord's ampere rating. Also, make sure that the total ampere rating of all the devices plugged into the wall outlet does not exceed the wall outlet's ampere rating.
- Do not attempt to service the units yourself.
- The units and power supplies can get warm in operation – do not situate them in an enclosed space without any ventilation.
- The units do not provide ground isolation and should not be used for any applications that require ground isolation or galvanic isolation.

WARRANTY

Adder Technology Ltd warrants that this product shall be free from defects in workmanship and materials for a period of two years from the date of original purchase. If the product should fail to operate correctly in normal use during the warranty period, Adder will replace or repair it free of charge. No liability can be accepted for damage due to misuse or circumstances outside Adder's control. Also Adder will not be responsible for any loss, damage or injury arising directly or indirectly from the use of this product. Adder's total liability under the terms of this warranty shall in all circumstances be limited to the replacement value of this product.

If any difficulty is experienced in the installation or use of this product that you are unable to resolve, please contact your supplier.

RADIO FREQUENCY ENERGY

A Category 6a (or better) twisted pair cable must be used to connect the units in order to maintain compliance with radio frequency energy emission regulations and ensure a suitably high level of immunity to electromagnetic disturbances.

All other interface cables used with this equipment must be shielded in order to maintain compliance with radio frequency energy emission regulations and ensure a suitably high level of immunity to electromagnetic disturbances.

European EMC directive 2004/108/EC

This equipment has been tested and found to comply with the limits for a class A computing device in accordance with the specifications in the European standard EN55022. These limits are designed to provide reasonable protection against harmful interference. This equipment generates, uses and can radiate radio frequency energy and if not installed and used in accordance with the instructions may cause harmful interference to radio or television reception. However, there is no guarantee that harmful interference will not occur in a particular installation. If this equipment does cause interference to radio or television reception, which can be determined by turning the equipment on and off, the user is encouraged to correct the interference with one or more of the following measures: (a) Reorient or relocate the receiving antenna. (b) Increase the separation between the equipment and the receiver. (c) Connect the equipment to an outlet on a circuit different from that to which the receiver is connected. (d) Consult the supplier or an experienced radio/TV technician for help.

FCC Compliance Statement (United States)

This equipment generates, uses and can radiate radio frequency energy and if not installed and used properly, that is, in strict accordance with the manufacturer's instructions, may cause interference to radio communication. It has been tested and found to comply with the limits for a class A computing device in accordance with the specifications in Subpart J of part 15 of FCC rules, which are designed to provide reasonable protection against such interference when the equipment is operated in a commercial environment. Operation of this equipment in a residential area may cause interference, in which case the user at his own expense will be required to take whatever measures may be necessary to correct the interference. Changes or modifications not expressly approved by the manufacturer could void the user's authority to operate the equipment.

Canadian Department of Communications RFI statement

This equipment does not exceed the class A limits for radio noise emissions from digital apparatus set out in the radio interference regulations of the Canadian Department of Communications.

Le présent appareil numérique n'émet pas de bruits radioélectriques dépassant les limites applicables aux appareils numériques de la classe A prescrites dans le règlement sur le brouillage radioélectriques publié par le ministère des Communications du Canada.

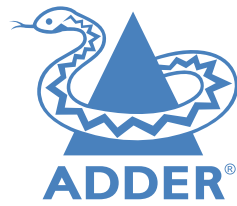

Web: www.adder.com

Contact: www.adder.com/contact-details

Support: forum.adder.com