

## User Manual 55" 4K 3840 x 2160 LCD



### AP-K55

8mm Aluminum front bezel

### NAP-K55

Front NEMA4 / IP65



### DP-K55

Aluminum Front Panel



### OP-K55

Universal Open Frame



Designed and manufactured by Austin Hughes

## Legal Information

First English printing, November 2018

Information in this document has been carefully checked for accuracy; however, no guarantee is given to the correctness of the contents. The information in this document is subject to change without notice. We are not liable for any injury or loss that results from the use of this equipment.

## Safety Instructions

**Please read all of these instructions carefully before you use the device. Save this manual for future reference.**

- Unplug equipment before cleaning. Don't use liquid or spray detergent; use a moist cloth.
- Keep equipment away from excessive humidity and heat. Preferably, keep it in an air-conditioned environment with temperatures not exceeding 40° Celsius (104° Fahrenheit).
- When installing, place the equipment on a sturdy, level surface to prevent it from accidentally falling and causing damage to other equipment or injury to persons nearby.
- When the equipment is in an open position, do not cover, block or in any way obstruct the gap between it and the power supply. Proper air convection is necessary to keep it from overheating.
- Arrange the equipment's power cord in such a way that others won't trip or fall over it.
- If you are using a power cord that didn't ship with the equipment, ensure that it is rated for the voltage and current labeled on the equipment's electrical ratings label. The voltage rating on the cord should be higher than the one listed on the equipment's ratings label.
- Observe all precautions and warnings attached to the equipment.
- If you don't intend on using the equipment for a long time, disconnect it from the power outlet to prevent being damaged by transient over-voltage.
- Keep all liquids away from the equipment to minimize the risk of accidental spillage. Liquid spilled on to the power supply or on other hardware may cause damage, fire or electrical shock.
- Only qualified service personnel should open the chassis. Opening it yourself could damage the equipment and invalidate its warranty.
- If any part of the equipment becomes damaged or stops functioning, have it checked by qualified service personnel.

## What the warranty does not cover

- Any product, on which the serial number has been defaced, modified or removed.
- Damage, deterioration or malfunction resulting from:
  - Accident, misuse, neglect, fire, water, lightning, or other acts of nature, unauthorized product modification, or failure to follow instructions supplied with the product.
  - Repair or attempted repair by anyone not authorized by us.
  - Any damage of the product due to shipment.
  - Removal or installation of the product.
  - Causes external to the product, such as electric power fluctuation or failure.
  - Use of supplies or parts not meeting our specifications.
  - Normal wear and tear.
  - Any other causes which does not relate to a product defect.
- Removal, installation, and set-up service charges.

## Regulatory Notices Federal Communications Commission (FCC)

This equipment has been tested and found to comply with the limits for a Class B digital device, pursuant to Part 15 of the FCC rules. These limits are designed to provide reasonable protection against harmful interference in a residential installation.

Any changes or modifications made to this equipment may void the user's authority to operate this equipment. This equipment generates, uses, and can radiate radio frequency energy and, if not installed and used in accordance with the instructions, may cause harmful interference to radio communications.

However, there is no guarantee that interference will not occur in a particular installation. If this equipment does cause harmful interference to radio or television reception, which can be determined by turning the equipment off and on, the user is encouraged to try to correct the interference by one or more of the following measures:

- Re-position or relocate the receiving antenna.
- Increase the separation between the equipment and receiver.
- Connect the equipment into an outlet on a circuit different from that to which the receiver is connected.

# Contents

## < Part. 1 > AP-K55 / NAP-K55

1.1	Package Content	P.1
1.2	Structure Diagram & Dimension	P.2 - 3
1.3	Mounting Hardware & Installation	P.4

## < Part. 2 > DP-K55

2.1	Package Content	P.5
2.2	Structure Diagram & Dimension	P.6 - 7
2.3	Mounting Hardware & Installation	P.8

## < Part. 3 > OP-K55

3.1	Package Content	P.9
3.2	Structure Diagram & Dimension	P.10 - 11
3.3	Mounting Hardware & Installation	P.12

## < Part. 4 > Specifications / OSD / Remote Controller

4.1	Product Specifications	P.13 - 14
4.2	On-screen Display Operation ( OSD )	P.15 - 17
4.3	Picture In Picture ( PIP ) / Picture By Picture ( PBP )	P.18 - 19
4.4	Remote Controller ( RC-2 )	P.20

## < Part. 5 > Options

5.1	Option Table	P.21
5.2	3G / HD / SD- <b>SDI</b> Broadcast-grade input	P.22
5.3	<b>MCS</b> Multi-display control solution	P.23
5.4	Touchscreen : Infrared 10-point	P.24
5.5	DC Power : 24V / 48V / 125V	P.25
5.6	MIL-type or lockable connector	P.26

## < Part. 6 > Ultraview Family

6.1	K55	P.27
-----	-----	------

## Before Installation

- It is very important to mount the equipment in a suitable cabinet or on a stable surface.
- Make sure the place has a good ventilation, is out of direct sunlight, away from sources of excessive dust, dirt, heat, water, moisture and vibration.

## Unpacking

The equipment comes with the standard parts shown in package content. Check and make sure they are included and in good condition. If anything is missing, or damaged, contact the supplier immediately.

## How To Clean Your LCD Monitor



### Caution :

- To avoid the risk of electric shock, make sure your hands are dry before unplugging your monitor from or plugging your monitor into an electrical outlet.
- When you clean your monitor, do not press down on the LCD screen. Pressing down on the screen can scratch or damage your display. Pressure damage is not covered under warranty.
- Use only cleansers made specifically for cleaning monitors and monitor screens. Cleansers not made to clean monitors and monitor screens can scratch the LCD display or strip off the finish.
- Do not spray any kind of liquid directly onto the screen or case of your monitor. Spraying liquids directly onto the screen or case can cause damage which is not covered under warranty.
- Do not use paper towels or abrasive pads to clean your monitor. Using an abrasive pad or any wood based paper product such as paper towels can scratch your LCD screen.

## Cleaning Your Monitor

To clean your LCD safely, please follow these steps :

- ① Disconnect the power cord.
- ② Gently wipe the surface using a clean, dry microfiber cloth. Use as little pressure as possible.

## Cleaning Tough Marks and Smudges

To remove tough marks and smudges, please follow these steps :

- ① Disconnect the power cord.
- ② Spray a small amount of non-abrasive cleanser on a microfiber cloth.



**Caution : Do not spray or apply any liquids directly onto the monitor. Always apply the solution to your microfiber cloth first, not directly on the parts you are cleaning.**

- ③ Gently wipe the surface. Use as little pressure as possible.
- ④ Wait until your monitor is completely dry before plugging it in and powering it up.

**AP-K55 / NAP-K55**



- 55" 4K LCD display X 1
- 6ft DP cable X 1
- Power cord X 1
- Remote controller X 1

**Basic I/O**

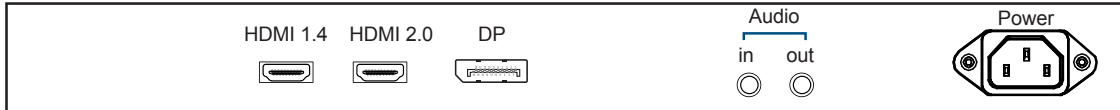

## < 1.2 > Structure Diagram - AP / NAP-K55

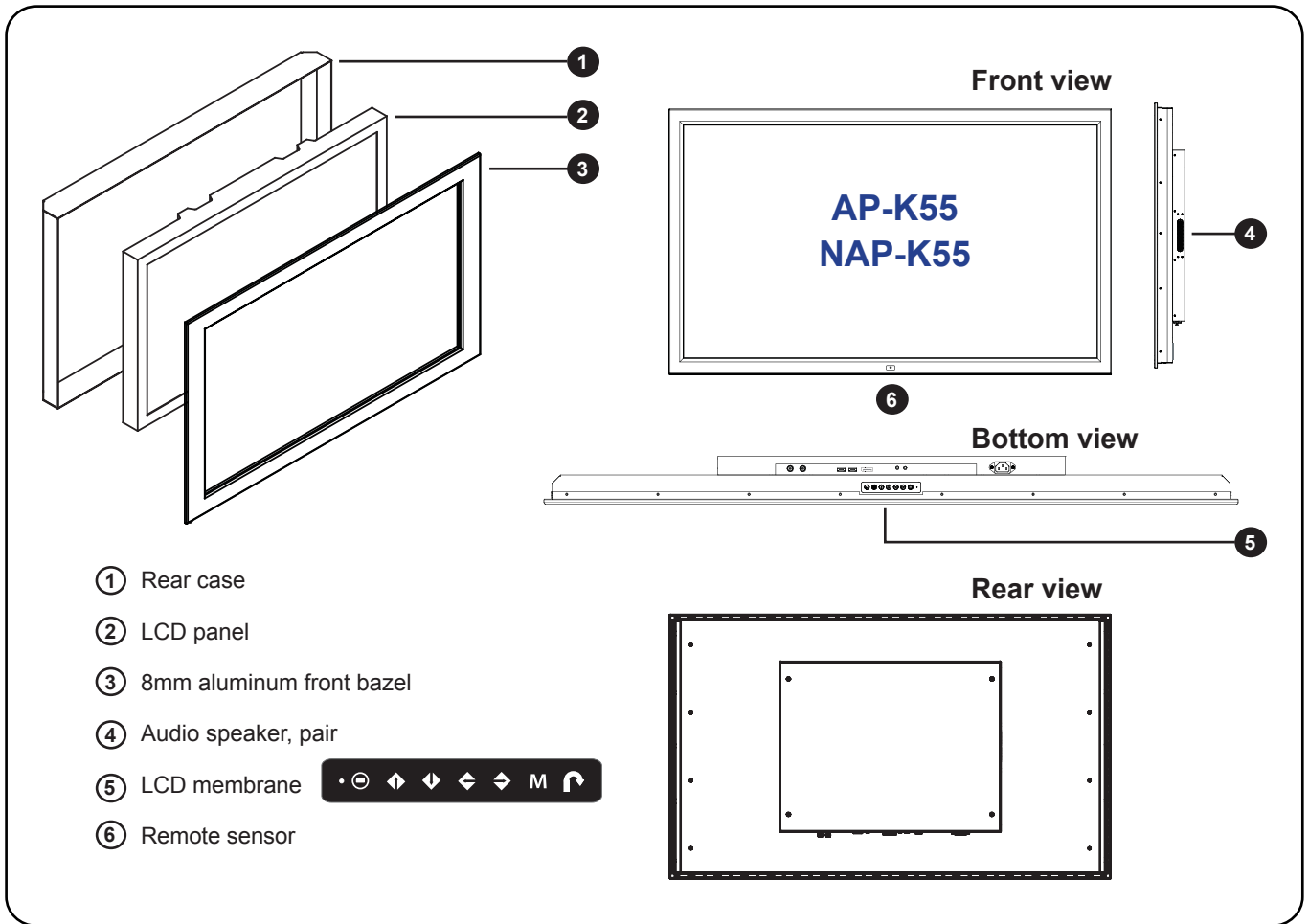

Model	Product Dimension (W x D x H)	Packing Dimension (W x D x H)	Net Weight	Gross Weight
<b>AP-K55</b>	1295 x 89.3 x 776 mm 51 x 3.5 x 30.6 inch	1455 x 212 x 917 mm 57.3 x 8.3 x 36.1 inch	40 kg 88 lbs	50 kg 110 lbs
<b>NAP-K55</b>	1295 x 89.3 x 776 mm 51 x 3.5 x 30.6 inch	1455 x 212 x 917 mm 57.3 x 8.3 x 36.1 inch	45 kg 99 lbs	55 kg 121 lbs

< 1.2 > Dimension - AP / NAP-K55

55" 4K LCD Display

Side View

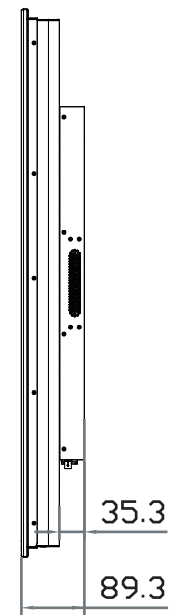
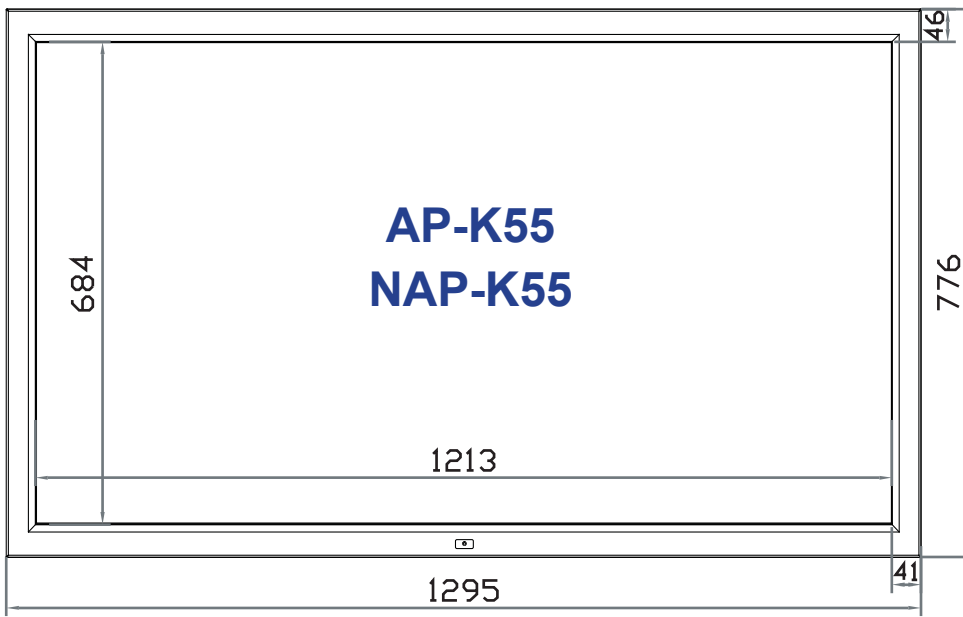

Rear View

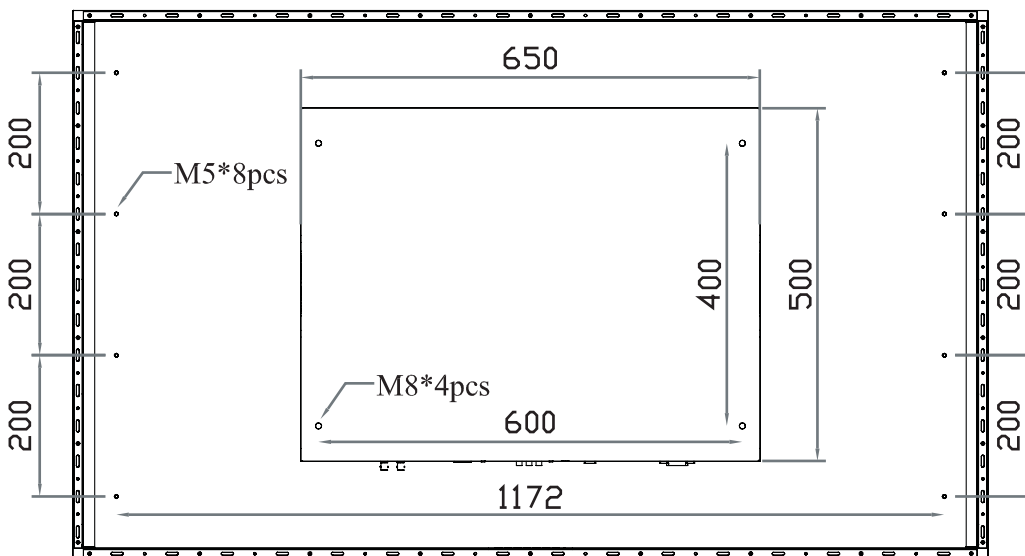

UNIT : mm  
1mm = 0.03937 inch

Bottom View

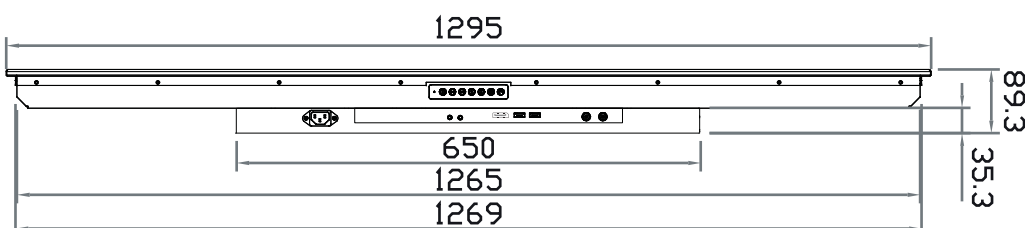

### < 1.3 > VESA Installation - AP / NAP-K55

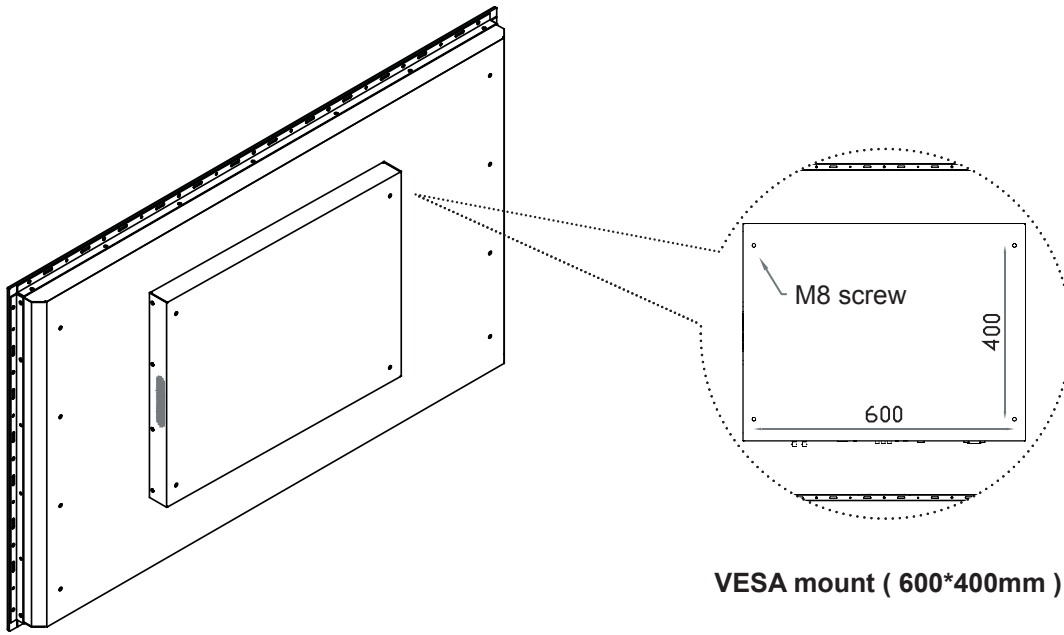

**VESA mount ( 600\*400mm )**

- Hardware and M8\*4 pcs for VESA mount are not provided



**DP-K55**



- 55" 4K LCD display X 1
- 6ft DP cable X 1
- Power cord X 1
- Remote controller X 1

**Basic I/O**



## < 2.2 > Structure Diagram - DP-K55

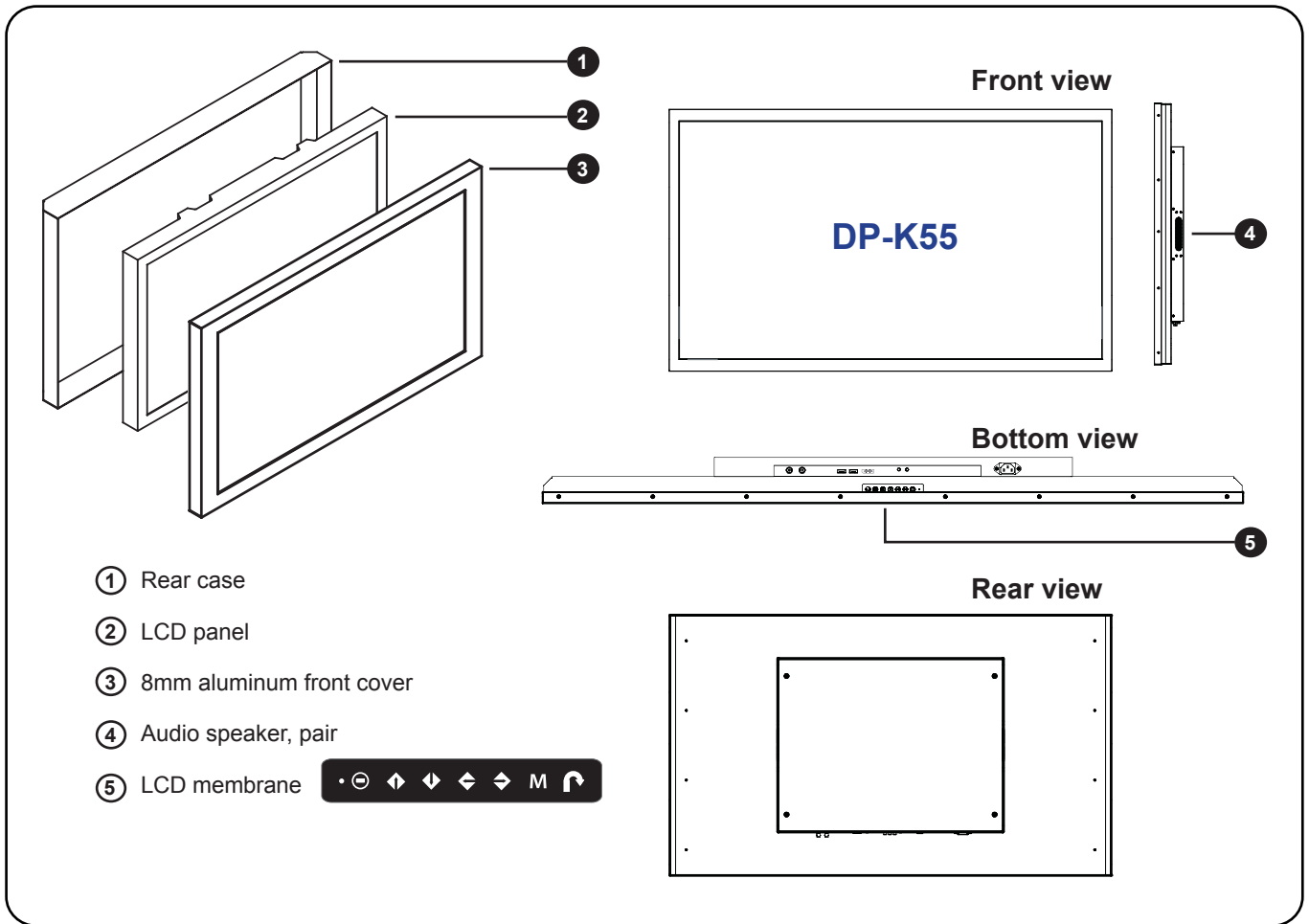

Model	Product Dimension (W x D x H)	Packing Dimension (W x D x H)	Net Weight	Gross Weight
DP-K55	1269 x 83.1 x 750 mm 50 x 3.3 x 29.5 inch	1455 x 212 x 917 mm 57.3 x 8.3 x 36.1 inch	37 kg 81.4 lbs	47 kg 103.4 lbs

< 2.2 > Dimension - DP-K55

55" 4K LCD Display

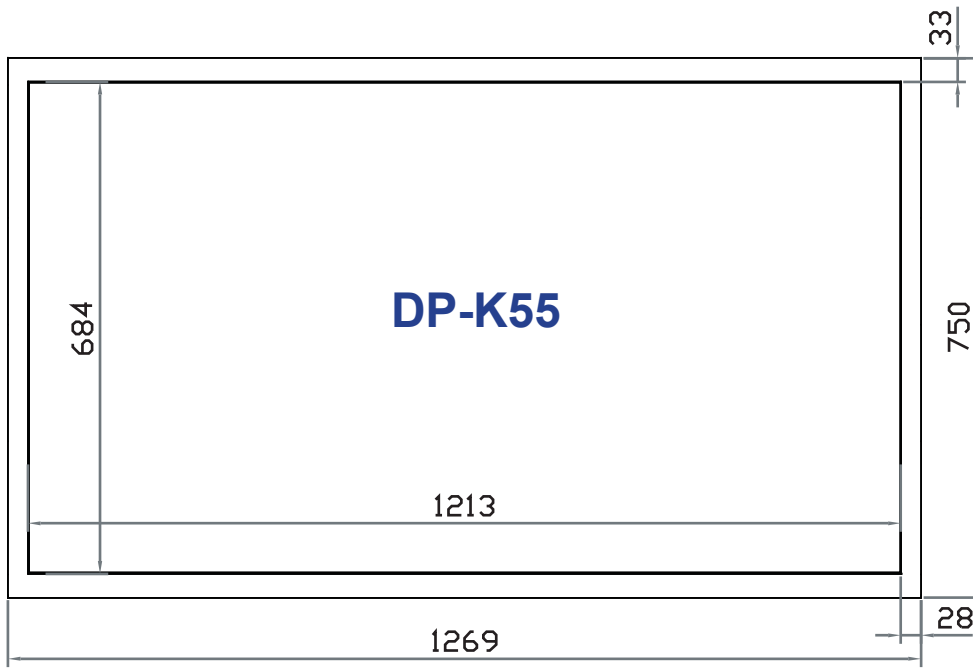

Side View

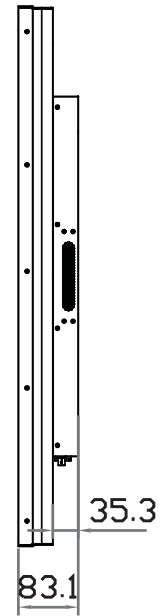

Rear View

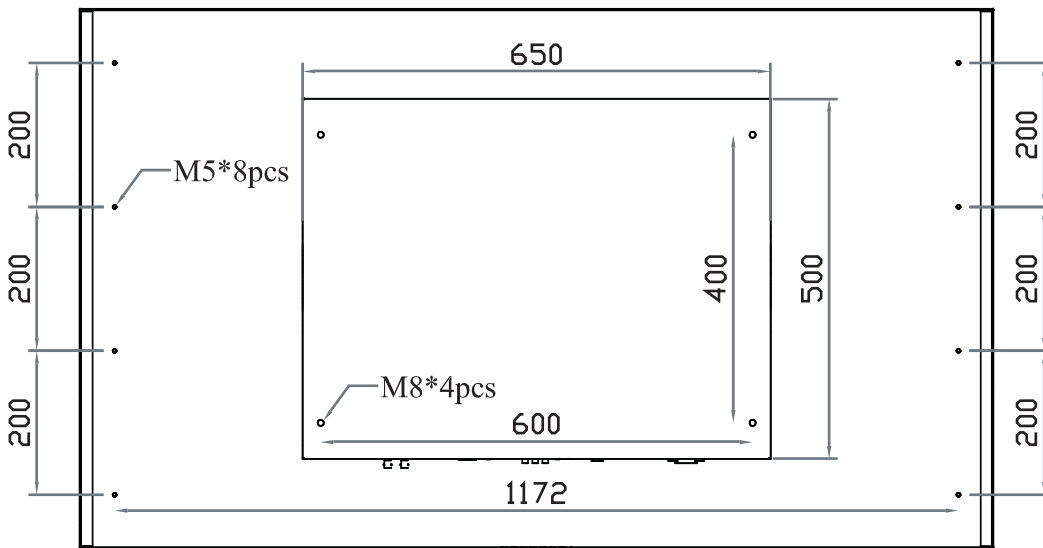

UNIT : mm  
1mm = 0.03937 inch

Bottom View

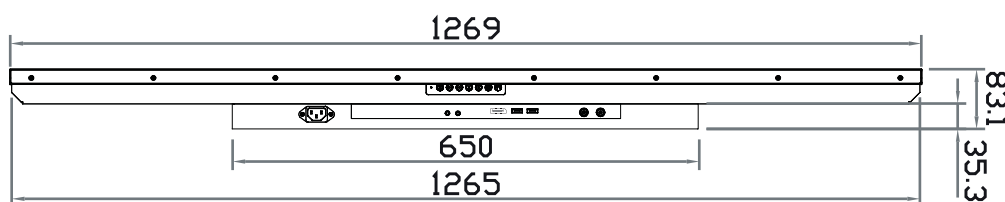

## < 2.3 > VESA Installation - DP-K55

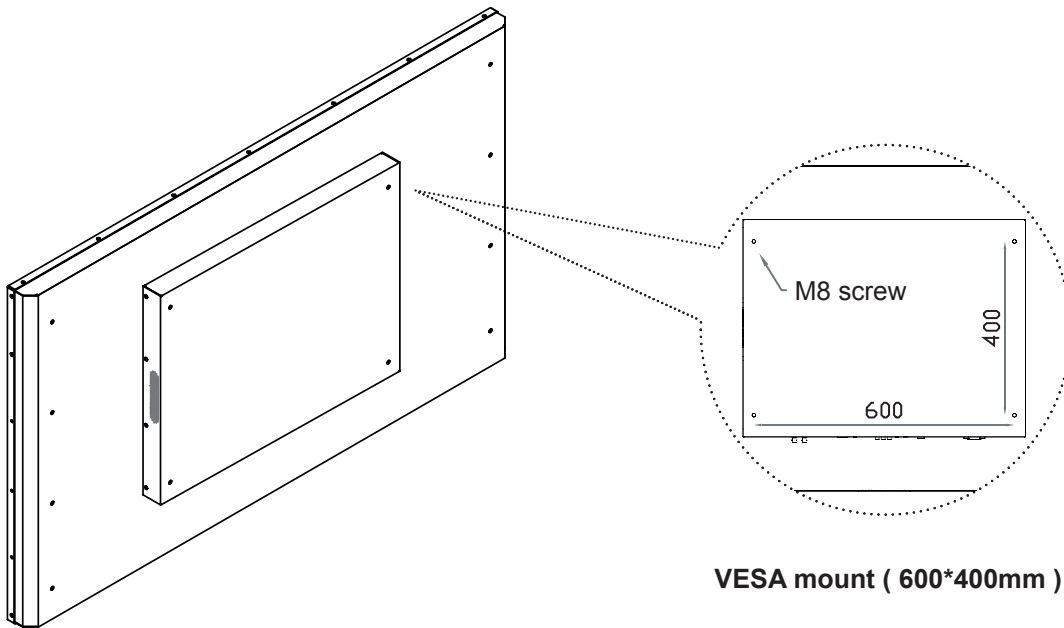

**VESA mount ( 600\*400mm )**

- Hardware and M8\*4 pcs for VESA mount are not provided

**OP-K55**



- 55" 4K LCD display X 1
- 6ft DP cable X 1
- Power cord X 1
- Remote controller X 1

**Basic I/O**



## < 3.2 > Structure Diagram - OP-K55

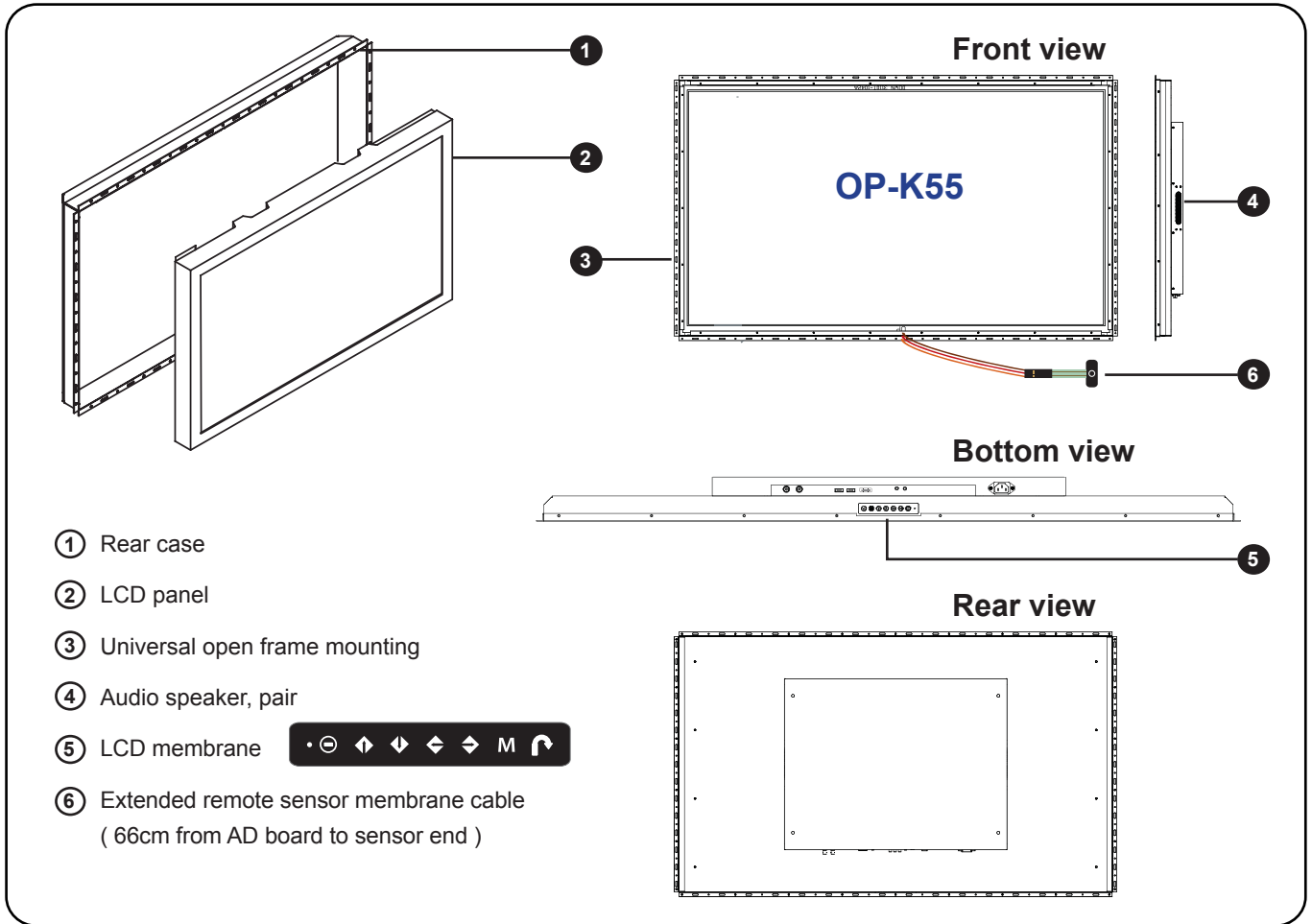

Model	Product Dimension (W x D x H)	Packing Dimension (W x D x H)	Net Weight	Gross Weight
OP-K55	1292 x 81.3 x 773 mm 50.9 x 3.3 x 30.4 inch	1455 x 212 x 917 mm 57.3 x 8.3 x 36.1 inch	33 kg 72.6 lbs	43 kg 94.6 lbs

< 3.2 > Dimension - OP-K55

55" 4K LCD Display

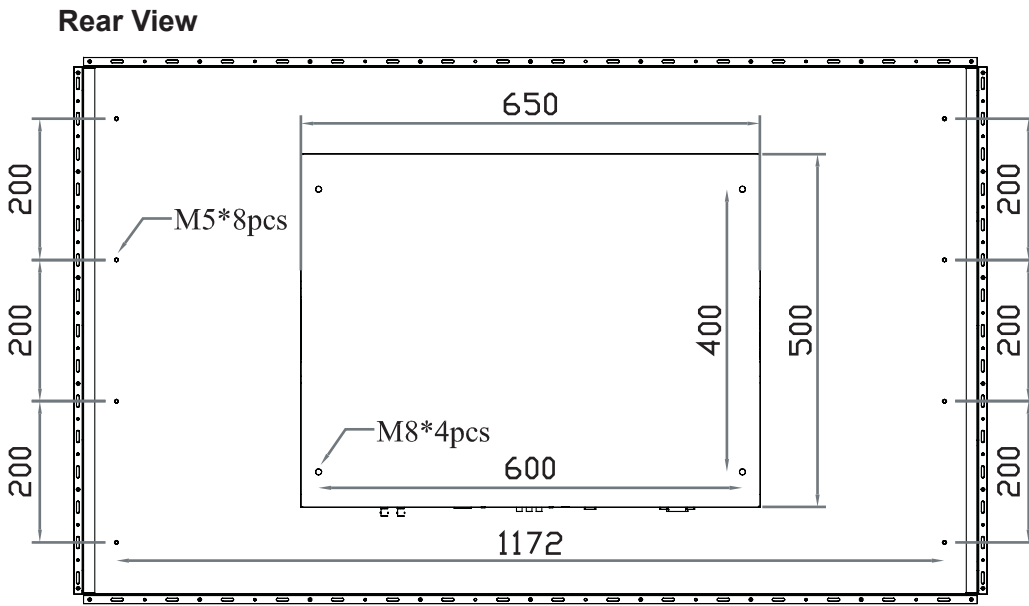
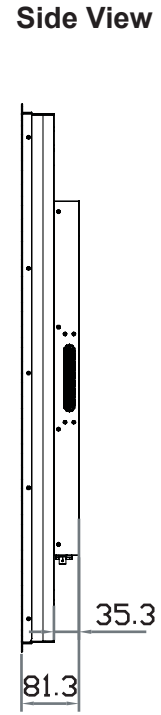
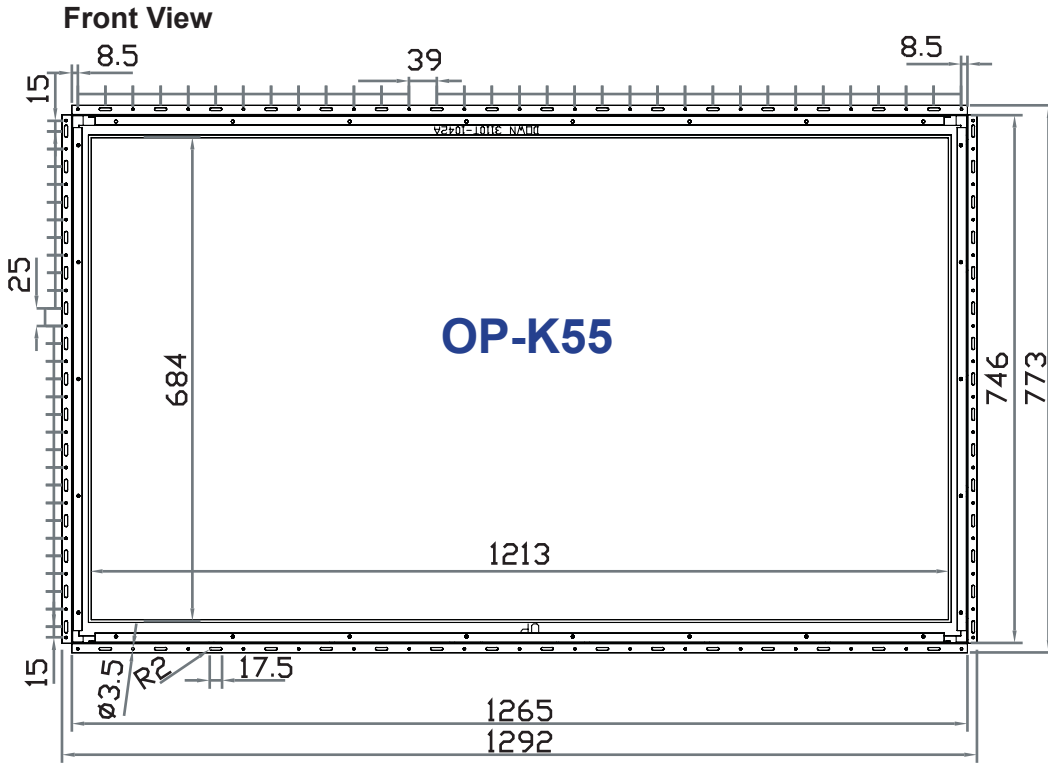

UNIT : mm  
1mm = 0.03937 inch

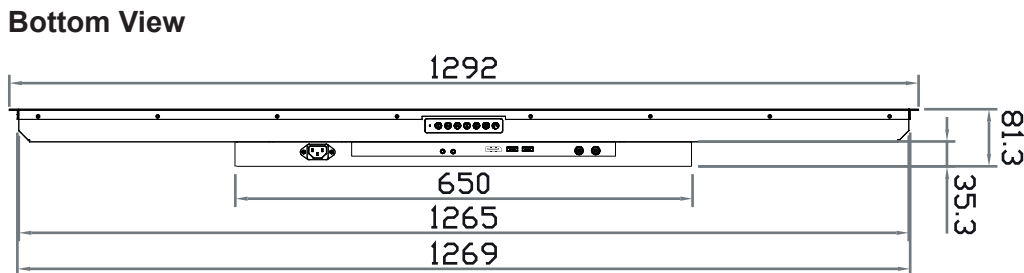

### < 3.3 > Installation - OP-K55

#### ( I ) Universal mount

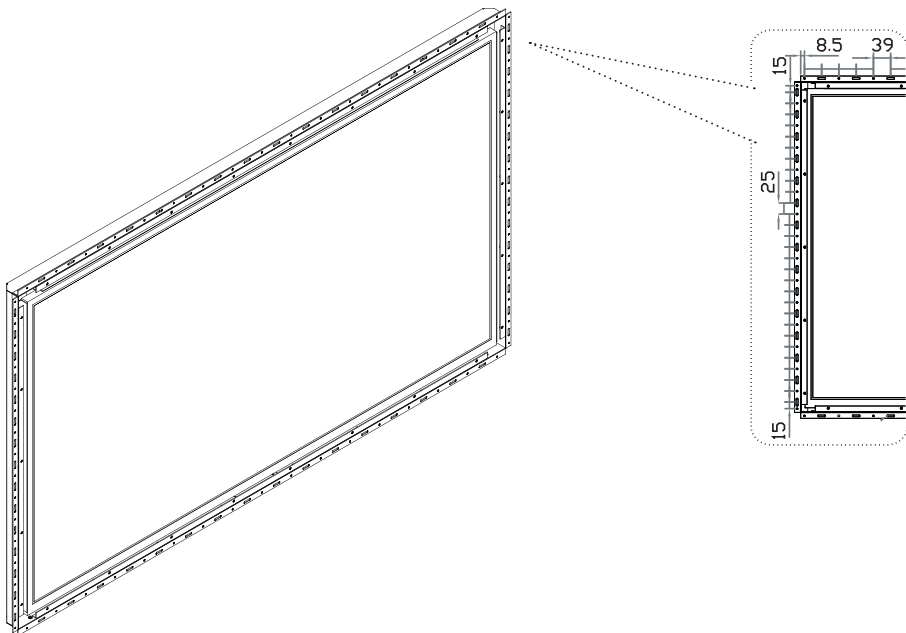

#### ( II ) VESA mount ( 600\*400mm )

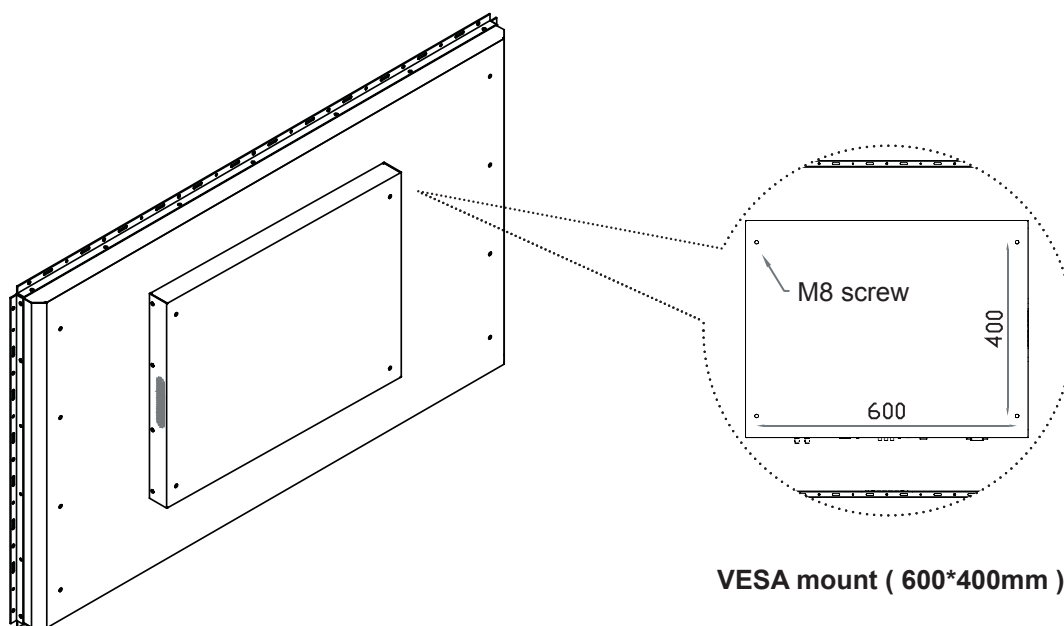

VESA mount ( 600\*400mm )

■ Hardware and M8\*4 pcs for VESA mount are not provided



## < Part 4 >

### < 4.1 > Product Specifications

### 55" 4K LCD Display

Mechanical Design		AP-K55	NAP-K55	DP-K55	OP-K55
	Protection	8mm front bezel	NEMA 4 / IP65	front cover	open frame
	Front Panel	Black, RAL 9005			-
	Rear Casing	Black, RAL 9005			
	VESA Mounting	600 x 400 mm		600 x 400 mm	600 x 400 mm
Other Mounting	-			Universal mount	

LCD Panel		Standard	Sunlight Readable
	Brightness ( cd/m <sup>2</sup> )	450	1500 <sup>***</sup>
	Contrast Ratio ( typ. )	1200 : 1	4000 : 1
	Panel Size ( diagonal )	55-inch Widescreen TFT color LCD	
	Native resolution	3840 x 2160	
	Colors	1.07 Billion, 10-bit	
	Viewing Angle ( L/R/U/D )	89/89/89/89	
	Response Time ( ms )	12	
	Dot pitch ( mm )	0.315	
	Display Area ( mm )	1209.60H x 680.40V	
	Surface treatment	Anti-glare	
	Surface hardness	2H	
	Backlight Type	LED	
	MTBF ( hrs )	30,000	

Video	Digital	Display port	DP 1.2 / HDCP 1.3
		HDMI	HDMI 2.0 / HDCP 2.2
			HDMI 1.4 / HDCP 1.4

Audio	Audio Output	Connector	3.5mm stereo jack
		Resistance / Power level	30kΩ / 2.8V
	Speaker	Dual Stereo Speaker	10W x 2

\*When the audio output is connected, speaker output is OFF

Power	Power Supply	Range	Auto-sensing 100 to 240VAC, 50 / 60Hz
	Power Consumption	Screen ON	Max. 100W
		Power saving mode	Max. 9W
		Power button OFF	Max. 2W

Compliance	EMC	FCC & CE certified
	Safety	CE / LVD certified
	Environment	RoHS2 & REACH compliant

## < 4.1 > Product Specifications

Environmental Conditions	Operating	Temperature	0 to 55°C degree
		Humidity	20~90%, non-condensing
		Altitude	16,000 ft
	Storage / Non-operating	Temperature	-20 to 60°C degree
		Humidity	5~90%, non-condensing
		Altitude	40,000 ft
		Shock	10G acceleration (11ms duration)
		Vibration	5~500Hz 1G RMS random





Physical Specification		AP-K55 / NAP-K55		DP-K55	OP-K55
	Product ( W x D x H )	1295 x 89.3 x 776 mm 51 x 3.5 x 30.6 inch	1269 x 83.1 x 750 mm 50 x 3.3 x 29.5 inch	1292 x 81.3 x 773 mm 50.9 x 3.3 x 30.4 inch	
Packing ( W x D x H )	1455 x 212 x 917 mm 57.3 x 8.3 x 36.1 inch	1455 x 212 x 917 mm 57.3 x 8.3 x 36.1 inch	1455 x 212 x 917 mm 57.3 x 8.3 x 36.1 inch		
Net Weight	40 kg / 88 lb	45 kg / 99 lb	37 kg / 81.4 lb	33 kg / 72.6 lb	
Gross Weight	50 kg / 110 lb	55 kg / 121 lb	47 kg / 103.4 lb	43 kg / 94.6 lb	

Applicable Format	Display Port Input	PC Signal	3840 x 2160 x 60Hz		
			1920 x 1080 x 60Hz		
			1600 x 1200 x 60Hz		
			1360 x 768 x 60Hz		
			1280 x 1024 x 60 / 75Hz		
			1280 x 768 x 60Hz		
			1024 x 768 x 60 / 70 / 75Hz		
			800 x 600 x 60 / 72 / 75Hz		
			720 x 400 x 70Hz		
			640 x 480 x 60 / 72 / 75Hz		
	HDMI Input	Audio Signal	2ch Linear PCM		
			HDMI 2.0	3840 x 2160 x 60Hz	
				HDMI 2.0 / 1.4	3840 x 2160 x 30Hz
				1920 x 1080 x 50 / 60Hz ( 1080p )	
1920 x 1080 x 25 / 30Hz ( 1080i )					
1280 x 720 x 50 / 60Hz ( 720p )					
720 x 480 x 50 / 60Hz ( 576p / 480p )					
HDMI Input	Audio Signal	2ch Linear PCM			

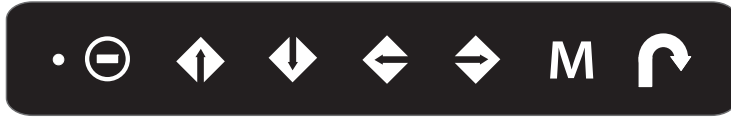
\* In some circumstances, if the user connects the LCD to PC via HDMI port for video and audio signals, the LCD may display incorrectly on a full screen. If so, please adjust the display card setting on display size to fix the issue.

- Power light
- Green = On
- Orange = Power saving



Membrane Switch	Function
	Power on / off LCD
	Display the OSD menu
	Scrolls through menu options and adjusts the displayed control (To auto adjustment by pressing the button  for 5 seconds)
	Exit the OSD screen Toggle analog, digital & video connection (DVI-D and video options only)

## < 4.2 > On-screen Display Operation ( OSD )

### ① Picture

Brightness : Adjust the screen brightness

Contrast : Adjust the difference between the image background ( black level ) and the foreground ( white level )

Black level : Adjust background black level of the screen

Eco : Screen in power saving mode

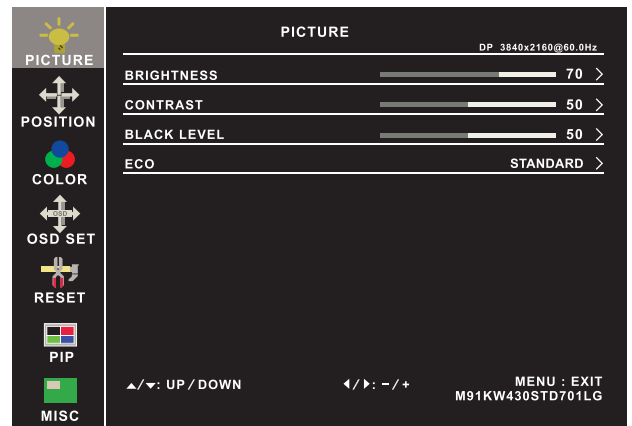

### ② Position

Picture size : Adjust the image size  
- Full Screen / 4:3 / 5:4 / Pixel to Pixel

DP version : Select the DP version

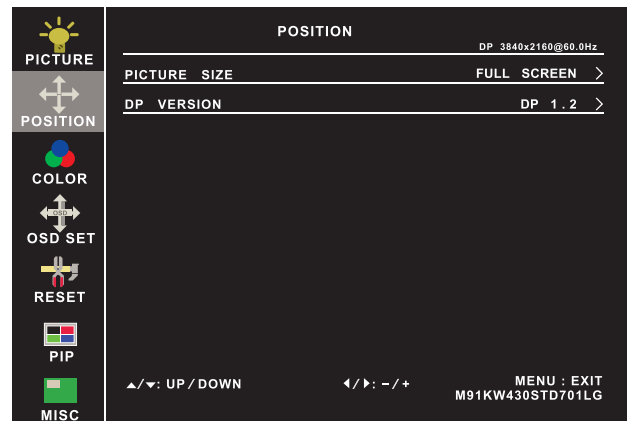

### ③ Color

Color temperature : User / Warm / Cool / 5400k mode and Red / Green / Blue color balance

Sharpness : Adjust the image from weak to sharp

Hue : Adjust the screen hue value

Saturation : Adjust the saturation of the image color

Dynamic

luminous control : Control the dynamic brightness

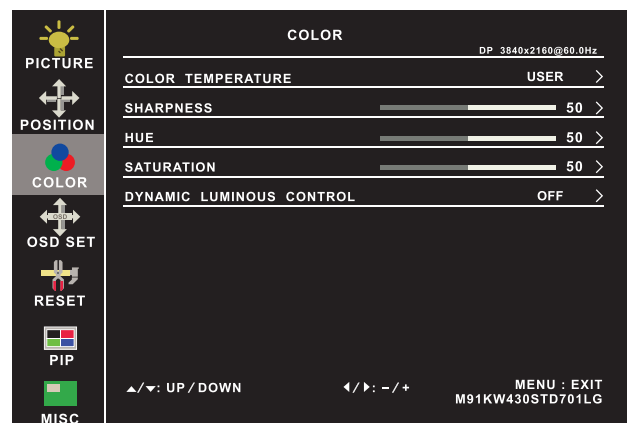

### ④ OSD Set

Language : Select the language in which the OSD menu is displayed - English

OSD H-Position : Align the screen image left or right

OSD V-Position : Align the screen image up or down

OSD time out : Adjust the screen timeout

OSD transparency : Adjust the screen transparency

OSD size : Adjust the screen size - Normal / Small

OSD rotation : Rotate the screen - 90° / 180° / 270°

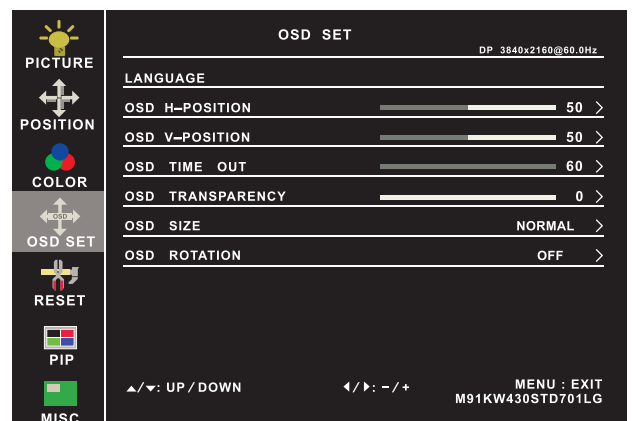

## < 4.2 > On-screen Display Operation ( OSD )

55" 4K LCD Display

### ⑤ Reset

Reset : Return the adjustment back to factory setting

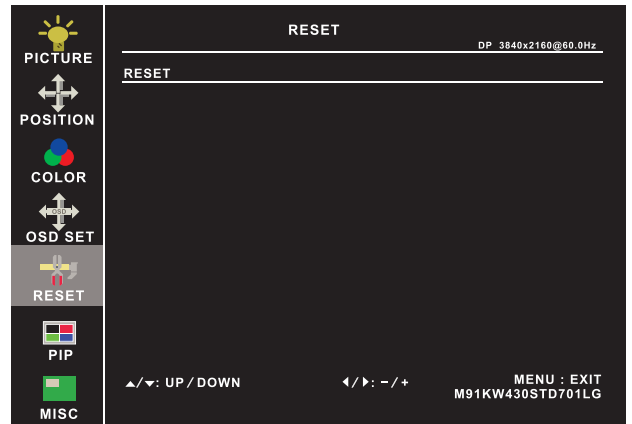

### ⑥ PIP

PIP mode : Enter into PIP / PBP setting - PIP MODE / PBP 2WIN ( Main screen + 1 sub screen ) / PBP 3WIN ( Main screen + 2 sub screen ) / PBP 4WIN ( Main screen + 3 sub screen )  
Select the signal input of each sub screen

PIP size : Adjust the size of the Sub screen  
- Small / Medium / Large / Huge

PIP position : Adjust the position of the Sub screen  
- Top Left / Top Right / Bottom Left / Bottom Right

Swap : Swap the input signal of PIP / PBP sub screen

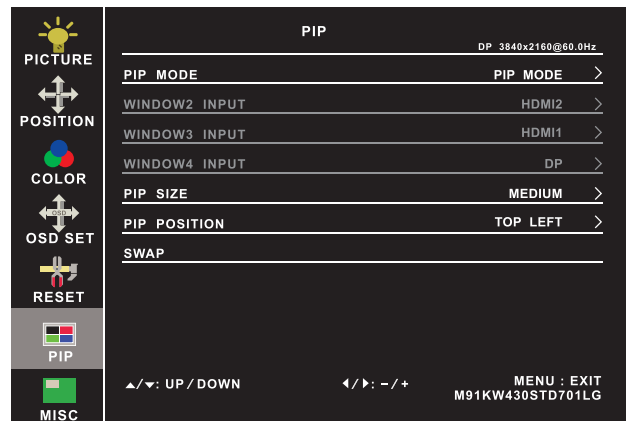

### ⑦ MISC

Signal source : Select the signal source - DP / HDMI1 / HDMI2

Mute : Turn off the surrounding sound

Audio in : Auto / Line in / DP

Volume : Adjust the volume of sound

Sleep mode : Set the off time - 10 min / 20 min / 30 min / 50 min / 60 min / 120 min / 240 min

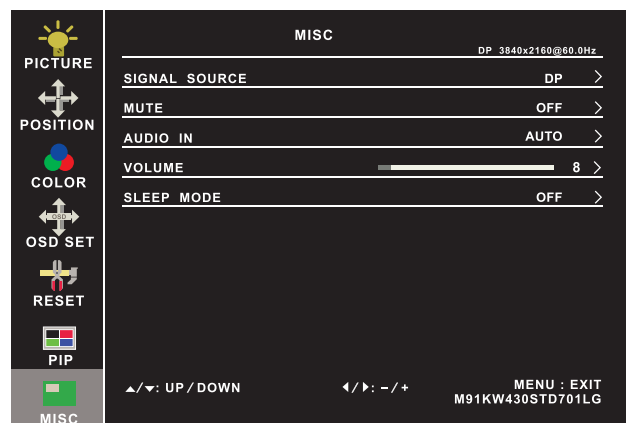

### Options on Reset page

Rotation : Rotate the image in Full screen or 1:1  
- 90° / 180° / 270°

Picture size : Adjust the image size in Full screen or 1:1

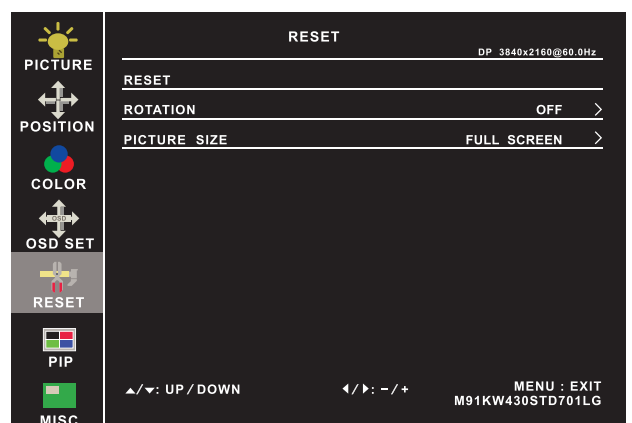

## < 4.3 > How to Use Picture In Picture ( PIP ) / Picture By Picture ( PBP )

### < 4.3.1 > Picture in Picture ( PIP )

#### Mode

Display the Sub screen in the Main screen.

OSD Menu → MISC → PIP Mode → Large / Small / OFF

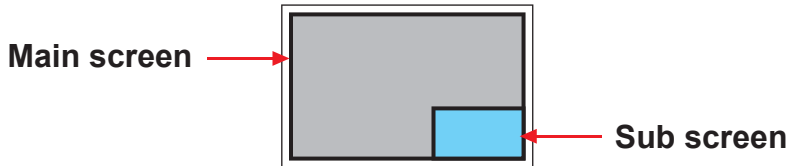

#### Position

Adjust the position of the Sub screen ( top left, bottom left, top right, bottom right )

OSD Menu → MISC → PIP Position → top left / top right / bottom left / bottom right

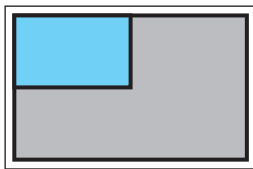

top left

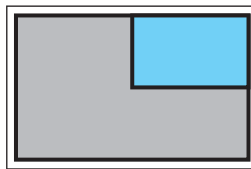

top right

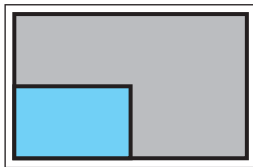

bottom left

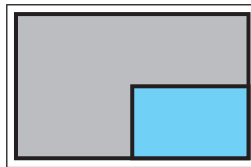

bottom right

#### Size

Adjust the size of the Sub screen ( Large / Small )

OSD Menu → MISC → PIP Mode → Large / Small

#### Size of Sub screen

LCD Monitor	Large Sub screen	Small Sub screen
1920 x 1200	552 x 414	480 x 360
1920 x 1080	552 x 414	480 x 360
1440 x 900	414 x 310	360 x 270
1366 x 768	392 x 294	340 x 254
1280 x 1024	368 x 276	320 x 240

< 4.3.2 > Picture By Picture ( PBP )

**Mode**

Display the Sub screen next to the Main screen.  
 OSD Menu → MISC → PIP Mode → PBP



**Size**

LCD Monitor	Main / Sub screen
1920 x 1200	955 x 716
1920 x 1080	955 x 716
1440 x 900	715 x 536
1366 x 768	678 x 508
1280 x 1024	635 x 476

< 4.3.3 > PIP / PBP Source

To select an input signal for PIP / PBP Sub screen.  
 OSD Menu → MISC → PIP Source → HDMI / SDI

The PIP / PBP is operable in the following table :

Main \ Sub	HDMI	SDI
HDMI	X	O
SDI	O	X

## < 4.4 > Remote Controller ( RC-2 )

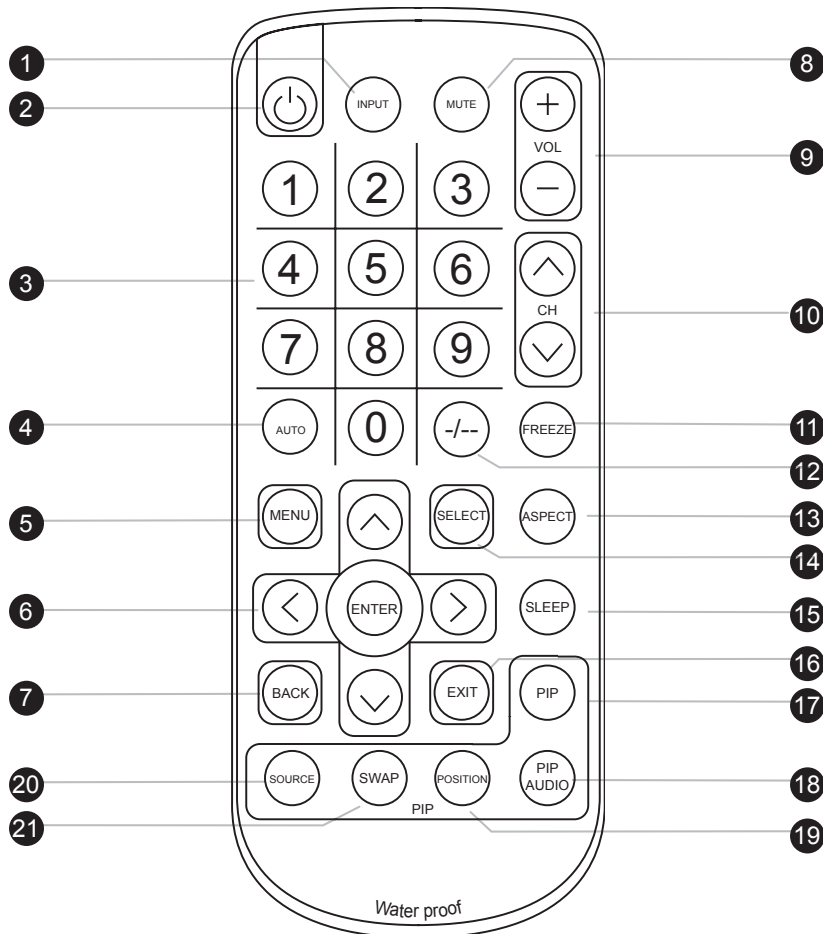

①	<b>INPUT</b>	Select the source
②	⏻	Switches on or off the TV
③	<b>0 - 9</b>	Only use in TV mode. Select channels. For channel numbers 10 and above, enter the second digit within two seconds.
④	<b>AUTO</b>	Auto adjust
⑤	<b>MENU</b>	Display the menu on the screen or go to the previous menu
⑥	▲ / ▼ / ◀ / ▶ / <b>ENTER</b>	Go to the upper menu or select the previous value / Go to the next menu or select the next value / Decrease the setting value / Increase the setting value or enter to the select item setting Enter to the select item settings or excude the setting
⑦	<b>BACK</b>	Back to previous value
⑧	<b>MUTE</b>	Turn on or off the speaker
⑨	<b>Vol + / -</b>	Increase or decrease the speaker volume
⑩	<b>CH + / -</b>	For TV model only, increase or decrease the channel number
⑪	<b>FREEZE</b>	Reserve for OEM model
⑫	<b>- / --</b>	For setting input single or double digits
⑬	<b>ASPECT</b>	Adjust the screen size
⑭	<b>SELECT</b>	To select the existing item
⑮	<b>SLEEP</b>	Select the sleeping time
⑯	<b>EXIT</b>	Exit the menu or cancel
<b>PIP functions</b>		
⑰	<b>PIP</b>	Picture in picture
⑱	<b>PIP AUDIO</b>	To set the audio of in PIP mode
⑲	<b>POSITION</b>	To set the screen position in PIP mode
⑳	<b>SOURCE</b>	PIP Source
㉑	<b>SWAP</b>	Swap screen in PIP mode



< 5.1 > Option Table

Options	AP / NAP	DP	OP
SDI	✓	✓	✓
MCS multi-screen control	✓	✓	✓
Touchscreen	✓	✓	✓
MIL-type / lockable connector	✓	✓	✓
DC Power	✓	✓	✓

## < 5.2 > Options : 3G / HD / SD-SDI input



Austin Hughes' SDI input is an ideal solution for the broadcast-grade video and high resolution CCTV market.

Designed for use with UltraView displays, a SDI input module can support up to 1080p @60Hz resolution without using additional space or power and it comes standard with a 2-year warranty.

### SDI

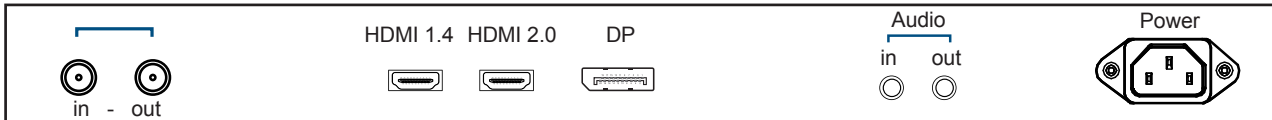

<b>INPUT</b>	3G-SDI IN	BNC x 1 / 0.8Vp-p ( 75 ohm )
	3G-SDI OUT	BNC x 1 / Active through, equalized & relocked

<b>Standard Compliance</b>	Video	SMPTE 425M / 274M / 296M / 125M ITU-R BT.656
	Audio	SMPTE 299M / 272M-C

<b>Compatible Video Format</b>	3G-SDI	1080p @60 / 50Hz, 4:2:2
		1080p @30 / 25 / 24Hz, 4:4:4
		1080i @60 / 50Hz, 4:4:4
		720p @60 / 50Hz, 4:4:4
	HD-SDI	1080p @30 / 25 / 24Hz, 4:2:2
		1080i @60 / 50Hz, 4:2:2
		720p @60 / 50Hz, 4:2:2
	SD-SDI	480i @60Hz, 4:2:2
	ITU-R BT.656	576i @50Hz, 4:2:2

<b>Compatible Audio Format</b>	3G-SDI	48kHz, 16 / 20 / 24 bit, 2 CH, Synchronized Video
	HD-SDI	48kHz, 16 / 20 / 24 bit, 2 CH, Synchronized Video
	SD-SDI	48kHz, 16 / 20 / 24 bit, 2 CH, Synchronized / Asynchronized Video

<b>Max. Transmission Distance 75 ohm coaxial cable</b>	3G-SDI	150m at 2.97Gb/s
	HD-SDI	250m at 1.485Gb/s
	SD-SDI	480m at 270Mb/s

**MCS**  
( Multi-display Control )

More control is always good. Especially when it is necessary and easy. Austin Hughes provides MCS solution to control the OSD of various UltraView LCD display up to 64 units.



The RS-232C is used for the communication between the PC and the first display via a 15 feet serial cable while the CAN bus is used for the various LCD displays cascade together via CAT 5/6 cable, and daisy chain up to 1,000 meters.

Designed for use with UltraView LCD displays, Austin Hughes provides a MCS input module without using additional space or power and it comes standard with a 2-year warranty.

**MCS**

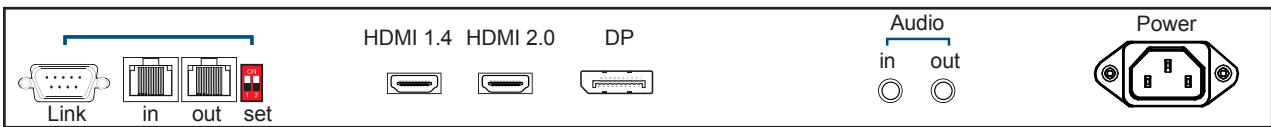

\*\*\* Please download the protocol of MCS control at :  
<http://www.austin-hughes.com/support/usermanual/ultraview/UM-UV-MCS.pdf>

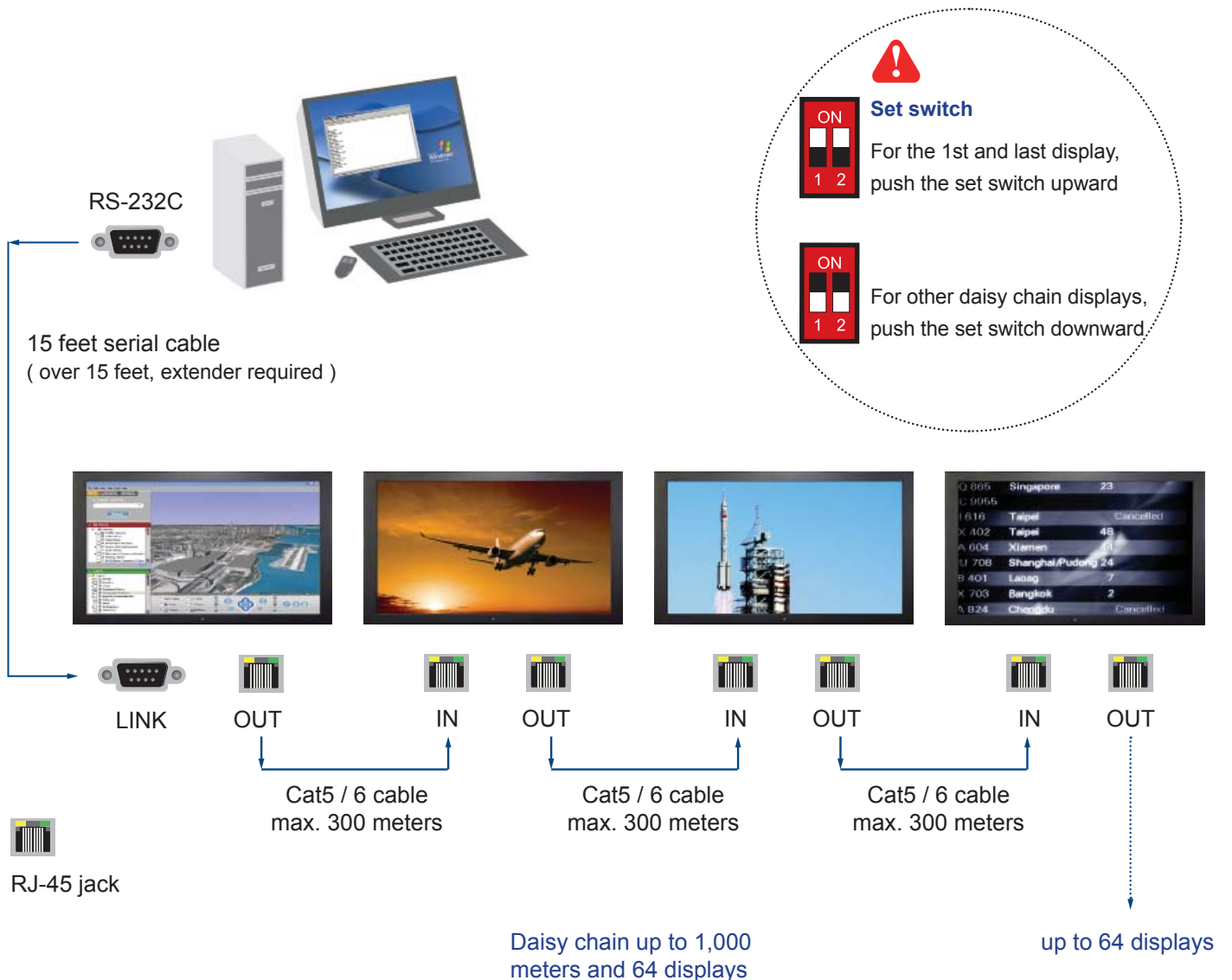

## < 5.4 > Options : Touchscreen & driver



### K55" USB Touchscreen Specification

<b>Model</b>	<b>K55-IR10</b> Multi-touch
<b>Technology</b>	Infrared
<b>Touch Point</b>	10
<b>Input Type</b>	Pen, Finger, Finger of gloved hand activation
<b>Touch Point Accuracy</b>	± 2 mm
<b>Response Speed</b>	≤ 15 ms
<b>Activation Force</b>	No minimum touch activation force
<b>Touch Durability</b>	Unlimited
<b>Glass Thickness</b>	3 mm
<b>Connector</b>	A-type USB
<b>Operating System</b>	Windows 7 / Windows 10

- Dimension will be changed if Multi-touch required
- USB touchscreen package includes 1 x 6ft USB cable, quick reference guideline and CD disc
- For detailed information, please refer to the attached CD disc
- As the touchscreen unit is not made of toughened glass, please handle it carefully

### USB Touchscreen

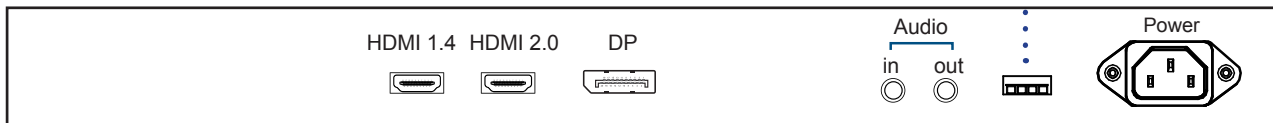

### K55-IR10 Driver



Connect the USB cable from the USB port on the LCD to a computer. The touch screen supports easy Plug-and-Play operations. There is no need to install additional drivers on the computer.

< 5.5 > Options : DC Power

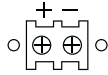

55" 4K LCD Display

Model	24V	48V	125V
<b>Input rating</b>			
Input voltage:	24-Volt	48-Volt	110-Volt
Input range:	18 ~ 36V	36 ~ 75V	43 ~ 160V
Input current			
- No load	100 mA	50 mA	10 mA
- Full load	7386 mA	3611 mA	1540 mA
<b>Output rating</b>			
Output voltage:	24-Volt	24-Volt	24-Volt
Output current:	6.25A	6.25A	6.25A
<b>Efficiency</b>	88%	90%	89%



\*\*\* For DC power option :

( 1 ) If the unit with LCD, earthing may be required 

## < 5.6 > Options : MIL-type or Lockable Connector

	Input	Part no.	MIL Standard
<b>MIL - type Connector</b>	DC Power *** ( Male )	MS3470W8-33P 	MIL - DTL - 26482
	VGA *** ( Male )	MS3470W14-15P 	MIL - DTL - 26482

\*\*\* There are several additional MIL DC and VGA connector types with varying design characteristics to meet cost considerations and to provide users with the most design flexibility possible. For more information, please contact us.

	Input	Part no.	Standard
<b>Lockable Connector</b>	DC Power ( Male )	YM-Ext-461CP001 	D-type 3W3
	USB	LUSB - A111 - 00 	-

\*\*\* MIL - type or Lockable connectors above can be integrated with our LCD displays. Sale service just for connectors not provided.

## < 6 > Ultraview K55 Family

### 450 cd/m<sup>2</sup> Brightness

8mm aluminum front bezel



**AP-K55**

8mm aluminum front bezel   
NEMA 4 / IP65 front protection



**NAP-K55**

Aluminum front cover



**DP-K55**

Universal open frame



**OP-K55**

### **MP-K55**

Industrial Display Kit

- 4K 55" LED
- LCD controller
- AC power

### 1500 cd/m<sup>2</sup> Sunlight Readable Brightness

8mm aluminum front bezel 



**HAP-K55**

8mm aluminum front bezel   
NEMA 4 / IP65 front protection



**NHAP-K55**

Aluminum front cover 



**HDP-K55**

Universal open frame 



**HOP-K55**

The company reserves the right to modify product specifications without prior notice and assumes no responsibility for any error which may appear in this publication.

All brand names, logo and registered trademarks are properties of their respective owners.

Copyright 2018 Austin Hughes Electronics Ltd. All rights reserved.