

4K ULTRA HD

6x2
SOURCES DISPLAYS

**Matrix for HDMI
with Ultra HD
4K x 2K support**

GTB-HD4K2K-642-BLK

User Manual

Release A4



**Gefen
TOOLBOX®**

Important Safety Instructions

GENERAL SAFETY INFORMATION

1. Read these instructions.
2. Keep these instructions.
3. Heed all warnings.
4. Follow all instructions.
5. Do not use this product near water.
6. Clean only with a dry cloth.
7. Do not block any ventilation openings. Install in accordance with the manufacturer's instructions.
8. Do not install or place this product near any heat sources such as radiators, heat registers, stoves, or other apparatus (including amplifiers) that produce heat.
9. Do not defeat the safety purpose of the polarized or grounding-type plug. A polarized plug has two blades with one wider than the other. A grounding type plug has two blades and a third grounding prong. The wide blade or the third prong are provided for your safety. If the provided plug does not fit into your outlet, consult an electrician for replacement of the obsolete outlet.
10. Protect the power cord from being walked on or pinched particularly at plugs, convenience receptacles, and the point where they exit from the apparatus.
11. Only use attachments/accessories specified by the manufacturer.
12. To reduce the risk of electric shock and/or damage to this product, never handle or touch this unit or power cord if your hands are wet or damp. Do not expose this product to rain or moisture.
13. Unplug this apparatus during lightning storms or when unused for long periods of time.
14. Refer all servicing to qualified service personnel. Servicing is required when the apparatus has been damaged in any way, such as power-supply cord or plug is damaged, liquid has been spilled or objects have fallen into the apparatus, the apparatus has been exposed to rain or moisture, does not operate normally, or has been dropped.
15. Batteries that may be included with this product and/or accessories should never be exposed to open flame or excessive heat. Always dispose of used batteries according to the instructions.

Warranty Information

Gefen warrants the equipment it manufactures to be free from defects in material and workmanship.

If equipment fails because of such defects and Gefen is notified within two (2) years from the date of shipment, Gefen will, at its option, repair or replace the equipment, provided that the equipment has not been subjected to mechanical, electrical, or other abuse or modifications. Equipment that fails under conditions other than those covered will be repaired at the current price of parts and labor in effect at the time of repair. Such repairs are warranted for ninety (90) days from the day of reshipment to the Buyer.

This warranty is in lieu of all other warranties expressed or implied, including without limitation, any implied warranty or merchantability or fitness for any particular purpose, all of which are expressly disclaimed.

1. Proof of sale may be required in order to claim warranty.
2. Customers outside the US are responsible for shipping charges to and from Gefen.
3. Copper cables are limited to a 30 day warranty and cables must be in their original condition.

The information in this manual has been carefully checked and is believed to be accurate. However, Gefen assumes no responsibility for any inaccuracies that may be contained in this manual. In no event will Gefen be liable for direct, indirect, special, incidental, or consequential damages resulting from any defect or omission in this manual, even if advised of the possibility of such damages. The technical information contained herein regarding the features and specifications is subject to change without notice.

For the latest warranty coverage information, refer to the Warranty and Return Policy under the Support section of the Gefen Web site at www.gefen.com.

PRODUCT REGISTRATION

Please register your product online by visiting the Register Product page under the Support section of the Gefen Web site.

Contacting Gefen Technical Support

Gefen, LLC
c/o Customer Service
20600 Nordhoff St.
Chatsworth, CA 91311

Telephone: (818) 772-9100
(800) 545-6900

Fax: (818) 772-9120

Email: support@gefentoolbox.com

Visit us on the Web: www.gefentoolbox.com

Technical Support Hours: 8:00 AM to 5:00 PM Monday - Friday, Pacific Time

6x2 Matrix for HDMI 4K x 2K is a trademark of Gefen, LLC.

Important Notice

Gefen, LLC reserves the right to make changes in the hardware, packaging, and any accompanying documentation without prior written notice.

HDMI, the HDMI logo, and High-Definition Multimedia Interface are trademarks or registered trademarks of HDMI Licensing in the United States and other countries.

© 2015 Gefen, LLC. All Rights Reserved.
All trademarks are the property of their respective owners.

Operating Notes

- EDID contains the A/V capabilities of a display device in regards to video resolutions and audio formats supported. This information is used by the source device to determine the format of the A/V signal on the outputs. The GefenToolBox 6x2 Matrix for HDMI 4K x 2K incorporates advanced EDID management to ensure compatibility with all sources and display devices.
- The GefenToolBox 6x2 Matrix for HDMI 4K x 2K can detect the presence of Deep Color (12-bit signal) automatically and will disable Deep Color EDID features across all other outputs if any connected device or display is not capable of processing Deep Color. This automatic behavior ensures compatibility among all output devices in a mixed-device environment. This feature cannot be disabled.
- When powering the GefenToolBox 6x2 Matrix for HDMI 4K x 2K or if the EDID mode is changed, the matrix will undergo a momentary initialization sequence. This is normal operation and may take a few seconds.
- The best way to operate and configure this unit is to use the built-in Web interface, which can be accessed by entering the IP address of the matrix into the address bar of any Web browser. See the section [RS-232 and IP Configuration](#) for more information about this feature.

Licensing

This product uses software that is subject to open source licenses, including one or more of the General Public License Version 2 and Version 2.1, Lesser General Public License Version 2.1 and Version 3, BSD, and BSD-style licenses. Distribution and use of this product is subject to the license terms and limitations of liability provided in those licenses. Specific license terms and Copyright Notifications are provided in the source code.

For three years from date of activation of this product, any party may request, and we will supply, for software covered by an applicable license (e.g. GPL or LGPL), a complete machine-readable copy of the corresponding open source code on a medium customarily used for software interchange. The following software and libraries are included with this product and subject to their respective open source licenses:

- lwIP
- jQuery

lwIP is licenced under the BSD licence:

Copyright (c) 2001-2004 Swedish Institute of Computer Science.
All rights reserved.

Redistribution and use in source and binary forms, with or without modification, are permitted provided that the following conditions are met:

1. Redistributions of source code must retain the above copyright notice, this list of conditions and the following disclaimer.
2. Redistributions in binary form must reproduce the above copyright notice, this list of conditions and the following disclaimer in the documentation and/or other materials provided with the distribution.
3. The name of the author may not be used to endorse or promote products derived from this software without specific prior written permission.

THIS SOFTWARE IS PROVIDED BY THE AUTHOR "AS IS" AND ANY EXPRESS OR IMPLIED WARRANTIES, INCLUDING, BUT NOT LIMITED TO, THE IMPLIED WARRANTIES OF MERCHANTABILITY AND FITNESS FOR A PARTICULAR PURPOSE ARE DISCLAIMED. IN NO EVENT SHALL THE AUTHOR BE LIABLE FOR ANY DIRECT, INDIRECT, INCIDENTAL, SPECIAL, EXEMPLARY, OR CONSEQUENTIAL DAMAGES (INCLUDING, BUT NOT LIMITED TO, PROCUREMENT OF SUBSTITUTE GOODS OR SERVICES; LOSS OF USE, DATA, OR PROFITS; OR BUSINESS INTERRUPTION) HOWEVER CAUSED AND ON ANY THEORY OF LIABILITY, WHETHER IN CONTRACT, STRICT LIABILITY, OR TORT (INCLUDING NEGLIGENCE OR OTHERWISE) ARISING IN ANY WAY OUT OF THE USE OF THIS SOFTWARE, EVEN IF ADVISED OF THE POSSIBILITY OF SUCH DAMAGE.

Features and Packing List

Features

- Routes six Ultra Hi-Def sources to two Ultra HD displays
- Supports resolutions up to Ultra HD 4K x 2K (3840 x 2160 @ 30Hz) and 1080p Full HD
- Supports 12-bit Deep Color
- 3DTV pass-through
- Lip Sync pass-through
- Push button controls for Routing, FST Modes, Audio, and EDID management
- FST Technology speeds up HDCP authentication process
- Advanced EDID Management for rapid integration of sources and displays
- Supports LPCM 7.1, Dolby® TrueHD, Dolby Digital® Plus, and DTS-HD Master Audio™
- Supports the use of DVI sources and DVI displays with HDMI-to-DVI adapters (not included)
- RS-232 Serial interface for remote control using a computer or automation control system
- IP control via Telnet, UDP, and the built-in web server interface
- IR remote control
- Field-upgradeable firmware via Mini-USB and IP ports
- Locking Power Supply
- Surface-mountable

4K ULTRA 



HDMI[®]
HIGH-DEFINITION MULTIMEDIA INTERFACE

1080P
PROGRESSIVE

HDCP
COMPLIANT

Packing List

The 6x2 Matrix for HDMI 4K x 2K ships with the items listed below. If any of these items are not present in your box when you first open it, immediately contact your dealer or Gefen.

- 1 x 6x2 Matrix for HDMI 4K x 2K
- 1 x DB-9 Cable
- 1 x IR Remote
- 1 x 5V DC Power Supply
- 1 x Quick-Start Guide

Table of Contents

01 Getting Started

Panel Layout	2
IR Remote Control Unit	5
Front	5
Back	6
Installing the Battery	7
Setting the IR Channel	7
Installation	8
Connecting the 6x2 Matrix for HDMI 4K x 2K	8
Sample Wiring Diagram	9

02 Operating the 6x2 Matrix for HDMI 4K x 2K

Routing Basics	12
Determining the Current Routing State	12
Routing Inputs to Outputs	13
Using the IR Remote Control Unit	14
Using the IR Extender	15
Switching Modes	16
What is Fast Switching Technology?	16
Fast Mode vs Slow Mode	16
Selecting the FST Mode	16
Audio Modes	17
Selecting the Audio Mode	17
EDID Modes	18
Available Modes	18
Selecting the EDID Mode	18

03 Advanced Operation

RS-232 and IP Configuration	22
RS-232 Interface	22
RS-232 Settings	22
IP / UDP Configuration	23
Commands	24
Configuration	24
FST	45
IP / Telnet Configuration	48
Masking	63
Routing / Naming / +5V / Presets	65
Status	75

Web Interface	79
Using the built-in Web Server	79
Main ► Routing	80
Main ► I/O Status	83
Main ► Display Info	85
I/O Setup ► Preset Names	86
I/O Setup ► I/O Names	87
I/O Setup ► HPD Control	88
I/O Setup ► FST	89
I/O Setup ► HDCP	90
Manage EDID ► Assign	91
Manage EDID ► Bank Names	94
Manage EDID ► Upload/Download	95
Configuration ► Change IP Settings	97
Configuration ► Telnet Login Settings	98
Configuration ► UDP Connection Settings	99
Configuration ► Web Login Settings	100
Configuration ► System Configuration	101

04 Appendix

Wall Mounting Instructions	106
Firmware Upgrade Procedure	107
Upgrading using the Web interface	107
Upgrading using the USB port	108
Specifications	109

4K ULTRA HD

6x2
SOURCES DISPLAYS

**Matrix for HDMI
with Ultra HD
4K x 2K support**

01 Getting Started

Panel Layout	2
IR Remote Control Unit	5
Front	5
Back	6
Installing the Battery	7
Setting the IR Channel	7
Installation	8
Connecting the 6x2 Matrix for HDMI 4K x 2K	8
Sample Wiring Diagram	9

Panel Layout



ID	Name	Description
1	Out (1 - 2)	Connect an Ultra HD display to each of these ports using an HDMI cables.
2	In (1 - 6)	Connect an HDMI cable from an Ultra Hi-Def source to any of these HDMI ports.
3	FST (Fast, Slow)	Use this recessed button to switch between Fast and Slow FST (Fast Switching Technology) modes. See Fast Mode vs Slow Mode for more information on using FST mode. The Fast and Slow LED indicators will display the current mode.
4	Audio (2ch, Multich)	Use this recessed button to switch between 2-channel and multichannel audio on the output. The 2ch and Multich LED indicators will display the current audio mode. See Selecting the Audio Mode for more information on using this feature.
5	EDID (Int, Ext, Custom)	Use this recessed button to switch between internal, external, and custom EDID modes. The Int , Ext , and Custom LED indicators will display the current EDID mode. See Selecting the EDID Mode for more information.
6	Out 1, Out 2	Press these buttons to change the routing state of the desired output. See Routing Inputs to Outputs for more information. The LED indicators (1 - 6) will indicate which input is currently routed to the output.
7	Optical Out (1 - 2)	Connect an optical cable between these TOSLINK® connectors on the matrix and an audio receiver. The Optical Out 1 outputs audio from the source that is routed to Out 1 . The Optical Out 2 outputs audio from the source that is routed to Out 2 . The Optical Out 1 and Optical Out 2 ports do not support lossless audio formats.

(continued on next page)

ID	Name	Description
8	Power	This LED indicator will glow bright blue when the included 5V DC power supply is connected between the matrix and an available electrical outlet.
9	RS-232	Connect an RS-232 cable from this port to an RS-232 device. See RS-232 and IP Configuration for more information.
10	IR Ext	Connect an IR Extender (Gefen part no. EXT-RMT-EXTIRN) to this port.
11	USB	Used for upgrading the firmware. See Firmware Upgrade Procedure for more information.
12	IR	This IR sensor receives signals from the included IR remote control unit.
13	IP Control	Connect an Ethernet cable between this jack and a LAN to use IP control. See RS-232 and IP Configuration for more information.
14	5V DC	Connect the included 5V DC power supply to this locking power receptacle.

IR Remote Control Unit

Front

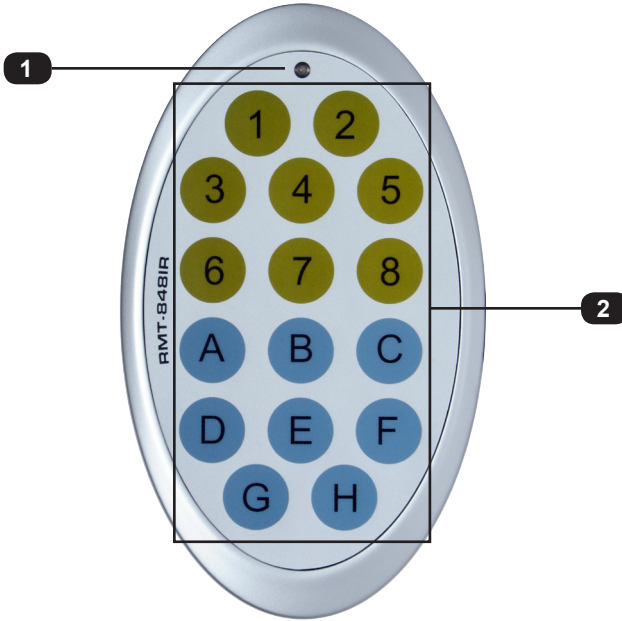

ID	Name	Description
1	Activity indicator	This LED flashes bright orange when a key is pressed on the remote.
2	Input Selection (1 - 8, A - H)	Press these buttons to switch to the desired input (source). Buttons 1 - 6 are used to select the input. Buttons A and B are used to select the output (Out 1 and Out 2). The remaining buttons are not used. See Using the IR Remote Control Unit for more information.



NOTE: An Activity indicator that flashes quickly while holding down any one of the buttons indicates a low battery. Replace the battery as soon as possible. See [Installing the Battery](#).

Back

(shown with cover removed)

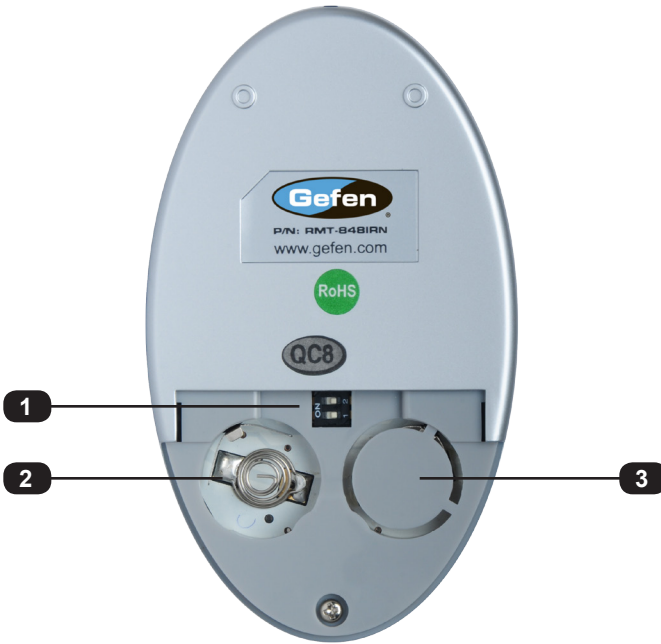

ID	Name	Description
1	DIP switch bank	Use these DIP switches to set the IR channel of the remote. See Setting the IR Channel for more information.
2	Primary battery slot (shown without battery)	Holds the battery for operating the remote. Use only 3V CR2032-type batteries. Make sure that the positive (+) side of the battery is facing up.
3	Alternate battery slot	Allows for the installation of secondary (backup) battery.

Installing the Battery

The IR remote control unit ships with two batteries. Only one battery is required for operation. The second battery is a spare.



WARNING: Use only 3V CR2032-type batteries. Risk of explosion if battery is replaced by an incorrect type. Dispose of used batteries according to the instructions.

1. Remove the back cover the IR Remote Control unit.
2. Insert the included battery into the primary battery slot. The positive (+) side of the battery should be facing up.
3. Replace the back cover.

Setting the IR Channel

In order for the included IR remote control to communicate with the 6x2 Matrix for HDMI 4K x 2K, the IR remote control must be set to the same channel as the matrix. Use the `#set_ir` command to set the IR channel of the matrix.



IR Channel	DIP settings
0 (default)	
1	
2	
3	

Installation

Connecting the 6x2 Matrix for HDMI 4K x 2K

1. Connect up to six Ultra Hi-Def sources to the input ports (**In 1 - In 6**) ports on the matrix.
2. Connect up to two Ultra HD displays using the output ports (**Out 1 - Out 2**) on the matrix.
3. Connect optical cables from each of the TOSLINK connectors (**Optical Out 1** and **Optical Out 2**) to separate A/V receivers. The **Optical Out 1** outputs audio from the source that is routed to **Out 1**. The **Optical Out 2** outputs audio from the source that is routed to **Out 2**.



NOTE: The **Optical Out 1** and **Optical Out 2** ports do not support lossless audio formats.

4. OPTIONAL: Connect an RS-232 cable from the **RS-232** port on the matrix to the RS-232 connector on the serial controller.
5. OPTIONAL: Connect an Ethernet cable from the **IP Control** port on the matrix to a Local Area Network (LAN).
6. OPTIONAL: Connect an IR extender (Gefen part no. EXT-RMT-EXTIRN) to the **IR Ext** port on the matrix.
7. Connect the included 5V DC locking power supply to the **5V DC** power receptacle on the matrix. Do not overtighten the locking power connector.
8. Connect the power supply to an available electrical outlet.

Sample Wiring Diagram

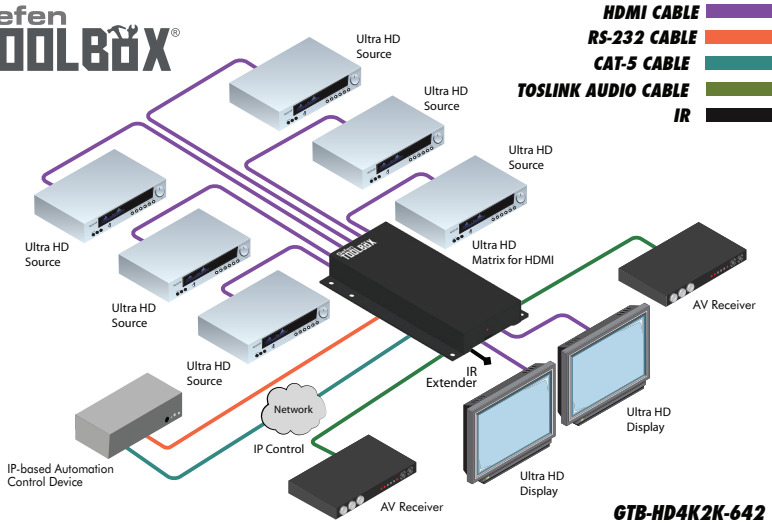



**Matrix for HDMI
with Ultra HD
4K x 2K support**

02 Operating the 6x2 Matrix for HDMI 4K x 2K

Routing Basics	12
Determining the Current Routing State	12
Routing Inputs to Outputs	13
Using the IR Remote Control Unit	14
Using the IR Extender	15
Switching Modes	16
What is Fast Switching Technology?	16
Fast Mode vs Slow Mode	16
Selecting the FST Mode	16
Audio Modes	17
Selecting the Audio Mode	17
EDID Modes	18
Available Modes	18
Selecting the EDID Mode	18

Routing Basics

Determining the Current Routing State

On the bottom-left portion of the matrix, there are two rows of six LED indicators. The top row of LED indicators displays the routing state of **Out 1**. The next row displays the routing state of **Out 2**. A row of numbers (1 - 6) is printed above the two rows of LED indicators. Each LED indicator represents an input (**In 1 - In 6**) on the matrix. The LED indicator for the currently selected input will glow solid green.



Routing Inputs to Outputs

To the left of each row of LED indicators, there are two push-buttons labeled **Out 1** and **Out 2**. To change the routing state of an output, press and release the button of the desired output to advance to the next input.

In the example below, the source connected to **In 5** is currently routed to **Out 2**.

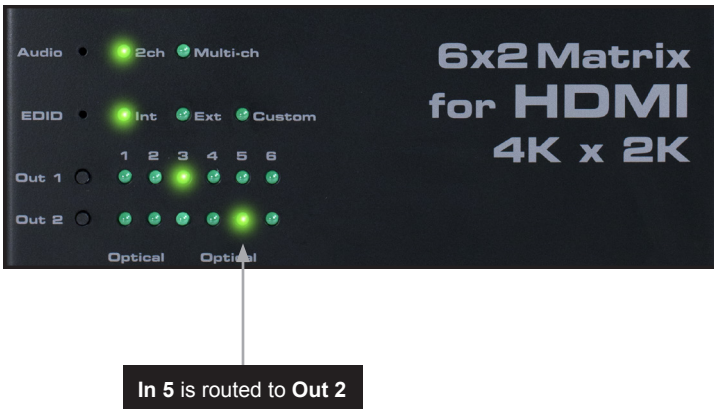

To change the routing state and route **In 6** to **Out 2**, press and release the **Out 2** button.

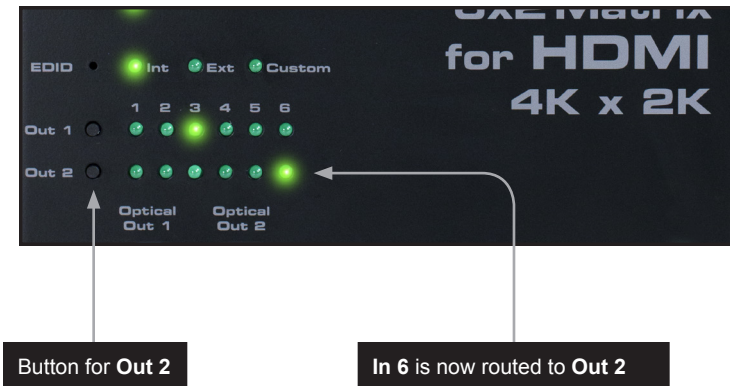

To route another source to **Out 2**, consecutively press and release the **Out 2** button until the desired input is selected.

Once **In 6** is selected for any of the outputs, pressing the **Out** button again will return to **In 1**.

Using the IR Remote Control Unit

The included IR remote control can also be used to switch between inputs. There are a total of 16 buttons on the IR remote. The buttons are color-coded in groups of two. Buttons 1 - 6 selects the desired input. Buttons **A** and **B** select the **Out 1** and **Out 2**, respectively. The remaining buttons are not used.

In the example, below, **In 5** is routed to **Out 2**. Let's change the routing state so that **In 6** is routed to **Out 2**:

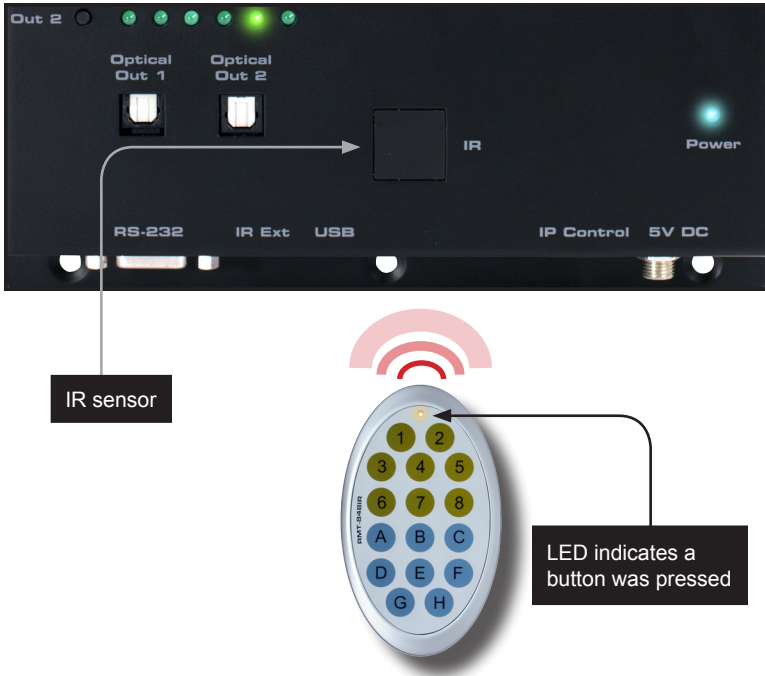

1. Point the IR remote at the IR sensor on the top panel of the matrix.
2. The output must always be selected first. Since we want to control the routing state of **Out 2**, press button **B** on the IR remote control.
3. Press button **6** on the IR remote control to select **In 6**.
4. The LED indicator for **In 6** will glow bright green, indicating that this input has been routed to **Out 2** (shown below).

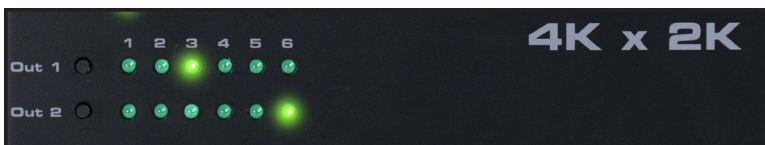

Using the IR Extender

There may be situations where the IR sensor is blocked by a cabinet or other mounting device. In this case, an IR extender (Gefen part no. EXT-RMT-EXTIRN) can be connected to the **IR Ext** port on the matrix. The sensor on the IR extender behaves exactly like the sensor on the top panel of the matrix. Always point the IR remote control unit at the IR sensor.

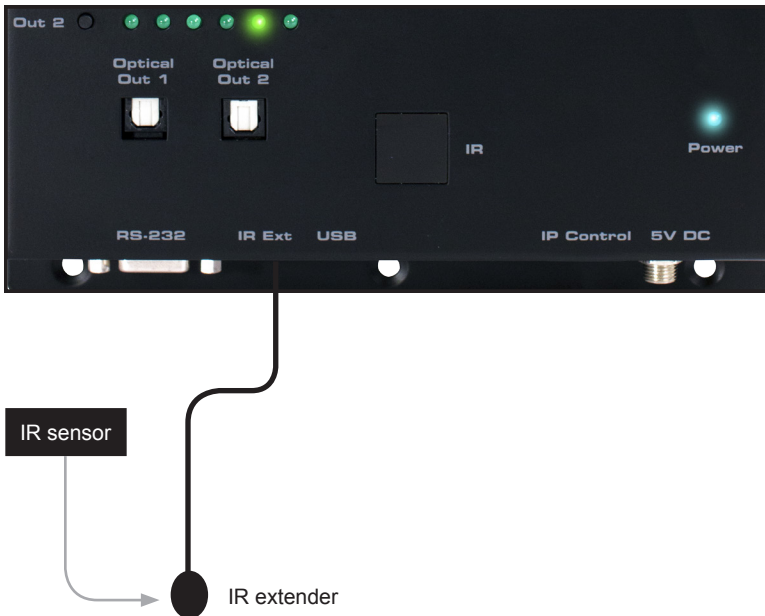

Switching Modes



What is Fast Switching Technology?

Fast Switching Technology (FST) is a Gefen software implementation for HDMI products. FST was created to improve the lengthy HDMI authentication process, based on the HDMI and HDCP specifications.

FST provides quicker audio/video source switching and greatly improves the overall audio/video system behavior and performance when more than one HDTV display is used in the system setup.

FST allows connecting / disconnecting or turning ON / OFF of HDTV displays without having these activities affect other Hi-Def sources routed to any other HDTV display in the same system.

Fast Mode vs Slow Mode

Use *fast* switching mode to improve performance when connecting / disconnecting Hi-Def sources, and powering ON / OFF HDTV displays.

Use *slow* mode when the source does not support multiple devices. When set to *slow* switching mode, the 6x2 Matrix for HDMI 4K x 2K will follow the standard authentication process, based on the HDMI and HDCP specifications.

Selecting the FST Mode

1. Use a paper clip or other pointed object to press and release the recessed **FST** button, to toggle between Fast and Slow modes.
2. The LED indicator will display the current FST mode.

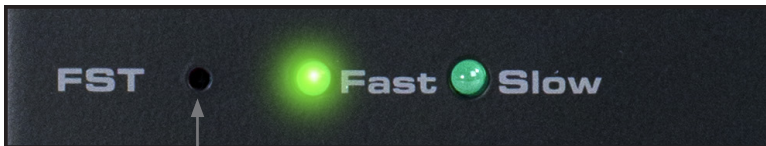

Press the **FST** button to switch the FST mode

Audio Modes

The 6x2 Matrix for HDMI 4K x 2K provides the capability to switch between 2-channel and multichannel audio output.

i **NOTE:** In order for the audio channel mode to be selected, the **EDID** switch must be set to the **Int** position. If the EDID switch is set to the **Ext** position, then the **Audio** switch will have no effect on the audio output signal. See [EDID Modes](#) for more information on using the EDID.

Selecting the Audio Mode

1. Use a paper clip or other pointed object to press and release the recessed **Audio** button, to toggle between 2-channel and multichannel audio modes.
2. The LED indicator will display the current audio mode.

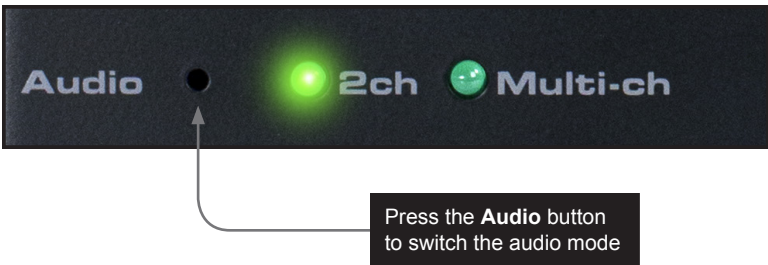

Supported audio formats

Audio Format	Audio Format
LPCM 2CH	LPCM 8-channel
Dolby® Digital	Dolby® Digital Plus
Dolby® TrueHD	DTS®
DTS-HD Master Audio™	MLP (PPCM)

i **NOTE:** When the Audio Mode is set the 2CH, the internal EDID will restrict the audio output to 2-channel LPCM, regardless of the audio input format.

EDID Modes

The 6x2 Matrix for HDMI 4K x 2K features EDID Management. Before the source can send video and/or audio to the display (sink), the source reads the EDID (Extended Display Identification Data) from the display (sink) devices connected to the splitter. The EDID contains information about what type of audio/video data that the source can send to each output device. The splitter can use either the downstream EDID (from the display/sink) or the built-in internal EDID.

Available Modes

- Internal EDID

Use this EDID mode if problems are encountered when using the external EDID. The built-in internal EDID provides the source device with a “generic” EDID which can be used by all display (sink) devices.

- External EDID

When set to **Ext** mode, EDID data will be fetched from each display (or other sink device) that is connected to the outputs of the matrix. Once this information is gathered, the matrix “builds” an EDID based on the highest video and audio formats that are supported by both sink devices. This EDID is then transmitted to each source device.

- Custom EDID

When set to Custom mode, the matrix will use a customized EDID configuration selected by the user. For example, each input can be individually set to different EDID modes to suit the needs of each input.

Selecting the EDID Mode

1. Use a paper clip or other pointed object to press and release the recessed **EDID** button, to toggle between internal, external, and custom EDID modes.
2. The LED indicator will display the current EDID mode.

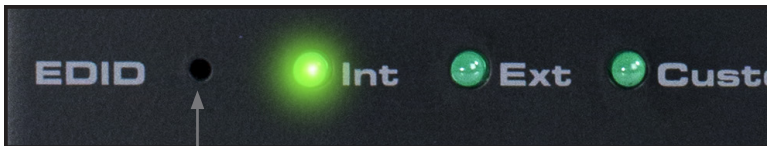

Press the **EDID** button to switch the EDID mode

See Table 2.1, below, for specifications on the internal EDID.

Table 2.1 - Internal EDID Specification

Video Data Block	Audio Data Block	Color Profile
640 x 480p 59/60 4:3	LPCM 2-channel	YCbCr 4:4:4
720 x 480p 59/60 4:3	LPCM 8-channel	YCbCr 4:2:2
720 x 480p 59/60 16:9	Dolby® Digital	
1280 x 720p 59/60 16:9	DTS®	
1920 x 1080i 59/60 16:9	Dolby® Digital Plus	
1440 x 480i 59/60 4:3	Dolby® TrueHD	
1920 x 1080p 59/60 16:9	DTS-HD Master Audio™	
720 x 576p 50 4:3	MLP (PPCM)	
720 x 576p 50 16:9		
1280 x 720p 50 16:9		
1920 x 1080i 50 16:9		
1440 x 576i 50 4:3		
1920 x 1080p 50 16:9		
1920 x 1080p 23/24 16:9		



**Matrix for HDMI
with Ultra HD
4K x 2K support**

03 Advanced Operation

RS-232 and IP Configuration	22
RS-232 Interface	22
RS-232 Settings	22
IP / UDP Configuration	23
Commands	24
Configuration	24
FST	45
IP / Telnet Configuration	48
Masking	63
Routing / Naming / +5V / Presets	65
Status	75
Web Interface	79
Using the built-in Web Server	79
Main ▶ Routing	80
Main ▶ I/O Status	83
Main ▶ Display Info	85
I/O Setup ▶ Preset Names	86
I/O Setup ▶ I/O Names	87
I/O Setup ▶ HPD Control	88
I/O Setup ▶ FST	89
I/O Setup ▶ HDCP	90
Manage EDID ▶ Assign	91
Manage EDID ▶ Bank Names	94
Manage EDID ▶ Upload/Download	95
Configuration ▶ Change IP Settings	97
Configuration ▶ Telnet Login Settings	98
Configuration ▶ UDP Connection Settings	99
Configuration ▶ Web Login Settings	100
Configuration ▶ System Configuration	101

RS-232 and IP Configuration

RS-232 Interface

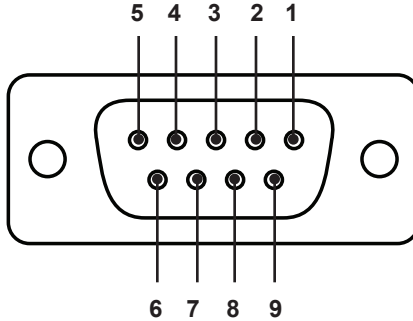

RS-232 Controller

Matrix

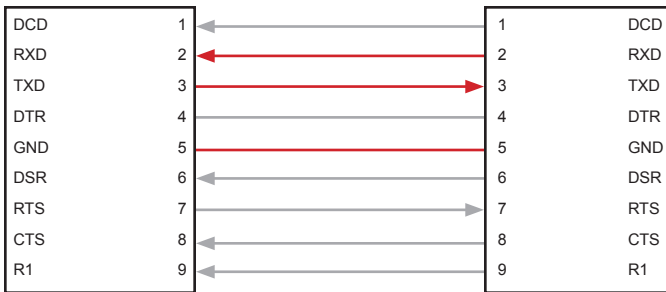

Only TXD, RXD, and GND pins are used.

RS-232 Settings

Description	Setting
Baud rate	19200
Data bits	8
Parity	None
Stop bits	1
Hardware flow control	None



IMPORTANT: When sending Telnet or RS-232 commands, a carriage return (0d) and a line feed (0a) must be included at the end of the command.

IP / UDP Configuration

The 6x2 Matrix for HDMI 4K x 2K supports IP-based control using Telnet, UDP, or the built-in Web-based GUI. To set up IP control, the network settings for the 6x2 Matrix for HDMI 4K x 2K must be configured via RS-232. The default network settings for the matrix are as follows:

Description	IP Address / Port	Description	IP Address / Port
IP Address	192.168.1.72	UDP Port	23
Subnet	255.255.255.0	Local UDP Port	50007
Gateway	192.168.1.254	Remote UDP IP	192.168.1.255
HTTP Port	80	Remote UDP Port	50008

1. Connect an RS-232 cable from the PC to the 6x2 Matrix for HDMI 4K x 2K. Also make sure that an Ethernet cable is connected between the matrix and the network.
2. Launch a terminal emulation program (e.g. HyperTerminal) and use the RS-232 settings listed on the previous page.



NOTE: Depending upon the network, all related IP, Telnet, and UDP settings will need to be assigned. Consult your network administrator to obtain the proper settings.

3. Set the IP address for the matrix using the `#sipadd` command.
4. Set the subnet mask using the `#snetmask` command.
5. Set the gateway (router) IP address using the `#sgateway` command.
6. Set the Telnet listening port using the `#set_telnet_port` command.
7. Set the HTTP listening port using the `#set_http_port` command.
8. Set the UDP remote IP address for the matrix using the `#set_udp_remote_ip` command.
9. Set the UDP listening port for the matrix using the `#set_udp_port` command.
10. Set the UDP remote port for the matrix using the `#set_udp_remote_port` command.
11. Reboot the matrix to apply all changes, then type the IP address that was specified in step 3, in a Web browser to access the Web GUI. Use the same IP address to Telnet to the matrix.

Commands

Configuration

Command	Description
<code>#echo</code>	Enables / disables RS-232 feedback
<code>#fadefault</code>	Resets the routing and masking to factory-default settings
<code>#hdcp</code>	Enables / disables HDCP detection
<code>#hdp_pulse</code>	Cycles with HPD line on the specified output
<code>#lock_edid</code>	Locks the local EDID when the matrix is power-cycled
<code>#power</code>	Toggles the power on the matrix
<code>#reboot</code>	Reboots the matrix
<code>#set_edid</code>	Sets the specified EDID to an input or bank
<code>#set_ir</code>	Sets the IR channel for the matrix
<code>#set_udp_port</code>	Sets the local UDP listening port
<code>#set_udp_remote_ip</code>	Sets the remote UDP IP address
<code>#set_udp_remote_port</code>	Sets the remote UDP listening port
<code>#show_hdcp</code>	Displays the HDCP status of the specified input
<code>#show_ir</code>	Displays the current IR channel of the matrix
<code>#show_out_colordpt</code>	Displays the maximum color depth supported by the display (sink) device based on the EDID
<code>#show_out_res</code>	Displays the maximum video resolution supported by the display (sink) device, based on the EDID
<code>#show_udp_port</code>	Displays the current local UDP listening port
<code>#show_udp_remote_ip</code>	Displays the current remote UDP IP address
<code>#show_udp_remote_port</code>	Displays the current remote UDP listening port
<code>#use_udp_enable</code>	Enables / disables UDP access
<code>n</code>	Displays the routing status of the output
<code>s</code>	Routes the specified input to the output

#echo

The #echo command enables / disables (toggles) the RS-232 feedback.

Syntax

```
#echo param1
```

Parameters

param1 Value [0 ... 1]

Value	Description
0	Disable feedback
1	Enable feedback

Example

```
#echo 1  
LOCAL ECHO ENABLED!
```

#fadefault

The #fadefault command resets the matrix to factory-default settings. Outputs are unmasked and all IP and UDP settings are reset to default settings.

Syntax

```
#fadefault
```

Parameters

None

Example

```
#fadefault
```

```
MATRIX WAS RESET TO FACTORY DEFAULTS
```

```
GTB-HD4K2K-642 V1.0G
```

#hdcpc

The #hdcpc command enables / disables HDCP detection on the selected input.



NOTE: Some computers will enable HDCP if an HDCP-compliant display is detected. Set *param2* = 1 to force the computer to ignore detection of an HDCP-compliant display. Setting *param2* = 0 does **not** decrypt HDCP content.

Syntax

```
#hdcpc param1 param2
```

Parameters

<i>param1</i>	Input	[1 ... 6]
<i>param2</i>	Value	[0 ... 1]

Value	Description
0	Disable
1	Enable

Example

```
#hdcpc 2 1  
HDCP ON INPUT 2 IS ENABLED
```

#hdp_pulse

The #hdp_pulse command cycles the HPD line on the specified input. Issuing this command is identical to physically disconnecting and reconnecting the cable between the source and the matrix. If *param1* = 0, then all inputs will receive the HPD pulse.

Syntax

```
#hdp_pulse param1
```

Parameters

<i>param1</i>	Input	[1 ... 6]
---------------	-------	-----------

Example

```
#hdp_pulse 1
HPD PULSE HAS BEEN SENT TO INPUT 01

#hdp_pulse 0
HPD PULSE HAS BEEN SENT TO ALL INPUTS
```

#lock_edid

The #lock_edid command secures the Local EDID by disabling the automatic loading of the downstream EDID when the matrix is powered.

Syntax

```
#lock_edid param1
```

Parameters

param1 Value [0 ... 1]

Value	Description
0	Disable
1	Enable

Example

```
#lock_edid 1  
MATRIX EDID IS : LOCKED
```

#power

The #power command toggles power on the matrix.

Syntax

```
#power param1
```

Parameters

param1 Value [0 ... 1]

Value	Description
0	Off
1	On

Example

```
#power 0  
POWER OFF
```

```
#power 1  
POWER ON
```

#reboot

The `#reboot` command reboots the matrix. Executing this command is the equivalent of disconnecting and reconnecting the AC power cord, on the back of the matrix. The matrix must be rebooted after changing any of the IP settings.

Syntax

```
#reboot
```

Parameters

None

Example

```
#reboot
```

```
MATRIX WILL REBOOT SHORTLY *REBOOT UNIT IN 2 SECONDS  
GTB-HD4K2K-642 V1.0G
```

#set_edid

The #set_edid command sets the specified EDID type to an input or bank. If *param1* = default or *param1* = dynamic, then set *param2* = 0.

Syntax

```
#set_edid param1 param2 param3 param4
```

Parameters

param1 Source [STRING]

Source	Description
default	Uses default (external) EDID
dynamic	Uses dynamic EDID
bank	Uses EDID bank
output	Uses EDID on Output (sink)

param2 Source [0 ... 8]

Source	Description
0	Default EDID / Dynamic
1 ... 8	EDID bank
1 ... 2	Output

param3 Target [STRING]

Target	Description
input	Specifies an input
bank	Specifies an EDID bank

param4 Value [1 ... 8]

Value	Description
1 ... 6	Input
1 ... 8	EDID bank

(continued on next page)

Examples

```
#set_edid default 0 input 2  
COPY DEFAULT EDID TO INPUT 4
```

```
#set_edid output 2 input 3  
COPY OUTPUT 2 EDID TO INPUT 3
```

```
#set_edid dynamic 0 input 2  
COPY DYNAMIC EDID TO INPUT 2
```

```
#set_edid bank 3 input 4  
COPY BANK 3 EDID TO INPUT 4
```

#set_ir

The `#set_ir` command sets the IR channel for the matrix. The default IR channel setting is 0. The IR channel for the switch can also be set under the **Configuration** tab within the Web interface. See [Configuration](#) ► [System Configuration](#) for more information.

Syntax

```
#set_ir param1
```

Parameters

param1

Channel

[0 ... 3]

Channel	Description
0	Set IR channel 0
1	Set IR channel 1
2	Set IR channel 2
3	Set IR channel 3

Example

```
#set_ir 1
IR CHANNEL IS SET TO CHANNEL 1
```

#set_udp_port

The `#set_udp_port` command sets the local UDP server listening port. The default port setting is 21. The matrix must be rebooted after executing this command. Use the `#show_udp_port` command to display the current local UDP listening port.

Syntax

```
#set_udp_port param1
```

Parameters

<i>param1</i>	Port	[0 ... 65535]
---------------	------	---------------

Example

```
#set_udp_port 56
UDP COMMUNICATION PORT : 56
```

#set_udp_remote_ip

The `#set_udp_remote_ip` command sets the remote UDP IP address. The IP address must be specified using dot-decimal notation. The default UDP remote IP address is 192.168.1.255. The matrix must be rebooted after executing this command.

Syntax

```
#set_udp_remote_ip param1
```

Parameters

<i>param1</i>	UDP address
---------------	-------------

Example

```
#set_udp_remote_ip 192.168.1.227
UDP REMOTE ADDRESS 192.168.1.227 IS SET. PLEASE REBOOT THE UNIT.
```

#set_udp_remote_port

The `#set_udp_remote_port` command sets the remote UDP listening port. The default remote UDP listening port is 50008. The matrix must be rebooted after executing this command.

Syntax

```
#set_udp_remote_port param1
```

Parameters

<i>param1</i>	Port	[0 ... 65535]
---------------	------	---------------

Example

```
#set_udp_remote_port 50008
UDP remote Communication Port : 50008
```

#show_hdcv

The #show_hdcv command displays the HDCP status on the specified input.

Syntax

```
#show_hdcv param1
```

Parameters

<i>param1</i>	Input	[1 ... 6]
---------------	-------	-----------

Example

```
#show_hdcv 1
HDCP ON INPUT 1 IS ENABLED
```

#show_ir

The #show_ir command displays the IR channel of the matrix.

Syntax

```
#show_ir
```

Parameters

None

Example

```
#show_ir
CURRENT IR CHANNEL IS: 1
```

#show_out_colordpt

The #show_out_colordpt command displays the highest color depth supported by the specified display based on the EDID. If no display is attached to the specified output, then the command will return `There is no information from output [X]`.

Syntax

```
#show_out_colordpt param1
```

Parameters

<i>param1</i>	Output	[1 ... 2]
---------------	--------	-----------

Example

```
#show_out_colordpt 1
OUTPUT 1 HIGHEST COLOR DEPTH IS 8 BITS
```

#show_out_res

The #show_out_res command displays the highest resolution supported by the specified display based on the EDID. If no display is attached to the specified output, then the command will return NO SIGNAL.

Syntax

```
#show_out_res
```

Parameters

<i>param1</i>	Output	[1 ... 2]
---------------	--------	-----------

Example

```
#show_out_res 1
OUTPUT 1 RESOLUTION IS 1600x900P
```

#show_udp_port

The #show_udp_port command displays the current local UDP listening port. Use the #set_udp_port command to set the local UDP listening port.

Syntax

```
#show_udp_port
```

Parameters

None

Example

```
#show_udp_port
UDP COMMUNICATION PORT : 56
```

#show_udp_remote_ip

The #show_udp_remote_ip command displays the remote UDP IP address. Use the #set_udp_remote_ip command to set the remote UDP IP address.

Syntax

```
#set_udp_remote_ip param1
```

Parameters

None

Example

```
#set_udp_remote_ip 192.168.1.227
UDP REMOTE ADDRESS IS: 192.168.1.227
```

#show_udp_remote_port

The #show_udp_remote_port command displays the remote UDP listening port. Use the #set_udp_remote_port to set the remote UDP listening port.

Syntax

```
#show_udp_remote_port param1
```

Parameters

None

Example

```
#show_udp_remote_port
UDP REMOTE COMMUNICATION PORT : 50008
```

#use_udp_enable

The #use_udp_enable command enables or disables UDP access mode.

Syntax

```
#use_udp_enable param1
```

Parameters

param1 Value [0 ... 1]

Value	Description
0	Disable UDP
1	Enable UDP

Example

```
#use_udp_enable 1
UDP ACCESS IS ENABLED
```

n

The `n` command displays the routing status of the output. Do not precede the `n` command with the '#' symbol. *param1* must be set to 1. If *param1* = 0, then the routing state for all outputs is returned.

Syntax

```
n param1
```

Parameters

<i>param1</i>	Output	[0 ... 2]
---------------	--------	-----------

Example

```
n 1
  INPUT 1 IS ROUTED TO OUTPUT 1

n 2
  INPUT 3 IS ROUTED TO OUTPUT 2

n 0
  INPUT 1 IS ROUTED TO OUTPUT 1
  INPUT 3 IS ROUTED TO OUTPUT 2
```

S

The `s` command routes the specified input to all outputs. Do not precede this command with the “#” symbol.

Syntax

```
s param1
```

Parameters

<i>param1</i>	Input	[1 ... 6]
---------------	-------	-----------

Examples

```
s 2
```

```
INPUT 2 IS ROUTED TO ALL OUTPUTS
```

FST

Command	Description
<code>#fst_fast</code>	Sets the specified inputs to Fast switching mode
<code>#fst_slow</code>	Sets the specified inputs to Slow switching mode
<code>#show_fst</code>	Displays the current switching mode for the specified input

#fst_fast

The `#fst_fast` command sets the specified inputs to *fast* switching mode. If *param1* = 0, then all inputs are set to *fast* switching mode. By default, all inputs are set to *fast* switching mode.

Syntax

```
#fst_fast param1 [...param6]
```

Parameters

param1 Input [0 ... 6]

Examples

```
#fst_fast 1  
INPUT 1 FST STATUS IS SET TO FST FAST MODE
```

```
#fst_fast 0  
ALL INPUT(S) ARE SET TO FST FAST MODE
```

#fst_slow

The #fst_slow command sets the specified inputs to *slow* switching mode. By default, all inputs are set to *fast* switching mode. If *param1* = 0, then all inputs are set to *slow* switching mode.

Syntax

```
#fst_slow param1
```

Parameters

<i>param1</i>	Input	[0 ... 6]
---------------	-------	-----------

Examples

```
#fst_slow 2
INPUT 2 FST STATUS IS SET TO FST SLOW MODE
```

```
#fst_slow 0
ALL INPUT(S) ARE SET TO FST SLOW MODE
```

#show_fst

The #show_fst command displays the switching mode for the specified input. If *param1* = 0, then the switching mode for all inputs are displayed.

Syntax

```
#show_fst param1
```

Parameters

<i>param1</i>	Input	[0 ... 6]
---------------	-------	-----------

Examples

```
#show_fst 2
INPUT 1 FST STATUS IS SLOW
```

```
#show_fst 0
INPUT 1 FST STATUS IS SLOW
INPUT 2 FST STATUS IS SLOW
INPUT 3 FST STATUS IS FAST
INPUT 4 FST STATUS IS SLOW
INPUT 5 FST STATUS IS FAST
INPUT 6 FST STATUS IS FAST
```

IP / Telnet Configuration

Command	Description
<code>#display_telnet_welcome</code>	Enable / disable the Telnet welcome message
<code>#ipconfig</code>	Displays the current IP configuration
<code>#resetip</code>	Resets the IP configuration to factory-default settings
<code>#set_http_port</code>	Sets the Web server listening port
<code>#set_telnet_pass</code>	Sets the Telnet password
<code>#set_telnet_port</code>	Sets the Telnet listening port for the matrix
<code>#set_webui_ad_pass</code>	Sets the Administrator password for the Web GUI
<code>#set_webui_op_pass</code>	Sets the Operator password for the Web GUI
<code>#sgateway</code>	Sets the IP address of the (router) gateway
<code>#show_gateway</code>	Displays the current gateway address of the matrix
<code>#show_http_port</code>	Displays the current HTTP listening port of the matrix
<code>#show_ip</code>	Displays the current IP address of the matrix
<code>#show_mac_addr</code>	Displays the MAC address of the matrix
<code>#show_netmask</code>	Displays the current net mask of the matrix
<code>#show_telnet_port</code>	Displays the Telnet listening port
<code>#show_telnet_username</code>	Displays the user name of the current Telnet session
<code>#show_ver_data</code>	Displays the current software and hardware version
<code>#sipadd</code>	Sets the IP address of the matrix
<code>#snetmask</code>	Sets the Net mask of the matrix
<code>#use_telnet_pass</code>	Force password during Telnet sessions

#display_telnet_welcome

The #display_telnet_welcome command enables / disables the Telnet welcome message during a Telnet session.

Syntax

```
#display_telnet_welcome
```

Parameters

param1 Value [0 ... 1]

Value	Description
0	Disable welcome message
1	Enable welcome message

Examples

```
#display_telnet_welcome 1
TELNET WELCOME SCREEN IS ENABLED
```

Notes

When this option is enabled and a Telnet session has been started, the following will appear:

```
Welcome to GTB-HD4K2K-642 TELNET.
Telnet->
```

#ipconfig

The #ipconfig command displays the current TCP settings.

Syntax

```
#ipconfig
```

Parameters

None

Examples

```
#ipconfig
```

```
IP CONFIGURATION IS:  
IP : 192.168.2.190  
SN : 255.255.255.0  
GW : 192.168.2.1
```

#resetip

The #resetip command resets the IP configuration to factory-default settings. The matrix must be rebooted after executing this command.

Syntax

```
#resetip
```

Parameters

None

Examples

```
#resetip
```

```
IP Configuration Was Reset To Factory Defaults.  
Please Reboot The Unit.
```

#set_http_port

The `#set_http_port` command specifies the Web server listening port. The matrix must be rebooted after executing this command. The default port setting is 80. Use the `#show_http_port` command to display the current HTTP listening port.

Syntax

```
#set_http_port param1
```

Parameters

<i>param1</i>	Port	[1 ... 1024]
---------------	------	--------------

Example

```
#set_http_port 82  
HTTP COMMUNICATION PORT 82 IS SET. PLEASE REBOOT THE UNIT.
```

#set_telnet_pass

The `#set_telnet_pass` command sets the Telnet password. The password is case-sensitive and cannot exceed 8 characters in length. The default password is `Admin`.

Syntax

```
#set_telnet_pass param1
```

Parameters

<i>param1</i>	Password
---------------	----------

Example

```
#set_telnet_pass 3ver3st
TELNET INTERFACE PASSWORD IS SET
```

#set_telnet_port

The `#set_telnet_port` command sets the Telnet listening port. The matrix must be rebooted after executing this command. The default port setting is `23`. Use the `#show_telnet_port` command to display the current Telnet listening port.

Syntax

```
#set_telnet_port param1
```

Parameters

<i>param1</i>	Port	[1 ... 1024]
---------------	------	--------------

Example

```
#set_telnet_port 24
TELNET COMMUNICATION PORT 24 IS SET. PLEASE REBOOT THE UNIT.
```

#set_webui_ad_pass

The `#set_webui_ad_pass` command sets the Administrator password for the Web GUI. The password is case-sensitive and cannot exceed 7 characters in length. The default password is `Admin`.

Syntax

```
#set_webui_ad_pass param1
```

Parameters

param1 Password

Example

```
#set_webui_ad_pass bossman
WEB UI ADMINISTRATOR PASSWORD IS SET
```

#set_webui_op_pass

The `#set_webui_ad_pass` command sets the Operator password for the Web GUI. The default password is `Admin`.

Syntax

```
#set_webui_op_pass param1
```

Parameters

param1 Password

Example

```
#set_webui_op_pass minion
WEB UI OPERATOR PASSWORD IS SET
```

#sgateway

The #sgateway command sets the gateway address. The gateway must be typed using dot-decimal notation. The matrix must be rebooted after executing this command. The default gateway is 192.168.1.1.

Syntax

```
#sgateway param1
```

Parameters

param1 Gateway

Example

```
#sgateway 192.168.1.5  
GATEWAY ADDRESS 192.168.1.5 IS SET. PLEASE REBOOT THE UNIT.
```

#show_gateway

The #show_gateway command displays the current gateway address of the matrix. Use the #sgateway command to set the gateway address.

Syntax

```
#show_gateway
```

Parameters

None

Example

```
#show_gateway  
GATEWAY ADDRESS IS: 192.168.1.5
```

#show_http_port

The `#show_http_port` command displays the current HTTP listening port of the matrix. Use the `#set_http_port` command to set the HTTP listening port.

Syntax

```
#show_http_port
```

Parameters

None

Example

```
#show_http_port
HTTP COMMUNICATION PORT IS 82
```

#show_ip

The `#show_ip` command displays the current IP address of the matrix. Use the `#sipadd` command to set the IP address.

Syntax

```
#show_ip
```

Parameters

None

Example

```
#show_ip
IP ADDRESS IS 192.168.2.190
```

#show_mac_addr

The #show_mac_addr command displays the MAC address of the matrix.

Syntax

```
#show_mac_addr
```

Parameters

None

Example

```
#show_mac_addr
MAC ADDRESS IS 10.12.34.56.79.aa
```

#show_netmask

The #show_netmask command displays the current net mask of the matrix. Use the #snetmask command to set the net mask.

Syntax

```
#show_netmask
```

Parameters

None

Example

```
#show_netmask
NET MASK ADDRESS IS 255.255.255.0
```

#show_telnet_port

The #show_telnet_port command displays the current Telnet port of the matrix. Use the #set_telnet_port command to set the Telnet listening port.

Syntax

```
#set_telnet_port param1
```

Parameters

None

Example

```
#show_telnet_port
TELNET COMMUNICATION PORT IS 24
```

#show_telnet_username

The #show_telnet_username command displays the user name of the current Telnet session.

Syntax

```
#show_telnet_username
```

Parameters

None

Example

```
#show_telnet_username
USER NAME FOR TELNET IS: Admin
```

#show_ver_data

The #show_ver_data command displays the current software and hardware version.

Syntax

```
#show_ver_data
```

Parameters

None

Example

```
#show_ver_data
SOFTWARE VERSION : V1.0G
HARDWARE VERSION : B
```

#sipadd

The #sipadd command sets the IP address of the matrix. The IP address must be entered using dot-decimal notation. The matrix must be rebooted after executing this command. The default IP address is 192.168.1.72. Use the #show_ip or #ipconfig command to display the current IP address of the matrix.

Syntax

```
#sipadd param1
```

Parameters

<i>param1</i>	IP address
---------------	------------

Example

```
#sipadd 192.168.2.190
IP ADDRESS 192.168.2.190 IS SET. PLEASE REBOOT THE UNIT.
```

#snetmask

The #snetmask command sets the subnet mask. The net mask must be entered using dot-decimal notation. The matrix must be rebooted after executing this command. The default net mask is 255.255.255.0. Use the #show_netmask or #ipconfig command to display the current net mask of the matrix.

Syntax

```
#snetmask param1
```

Parameters

<i>param1</i>	Net mask
---------------	----------

Example

```
#snetmask 255.255.0.0
NET MASK ADDRESS 192.168.2.1 IS SET. PLEASE REBOOT THE UNIT.
```

#use_telnet_pass

The `#use_telnet_pass` command forces the password credentials for each Telnet session. The default setting is 0 (disabled). Use the `#set_telnet_pass` command to set the Telnet password.

Syntax

```
#use_telnet_pass param1
```

Parameters

param1 Value [0 ... 1]

Value	Description
0	Disable password
1	Enable password

Example

```
#use_telnet_pass 1
TELNET INTERFACE PASSWORD IS ENABLED
```

Masking

Command	Description
<code>#mask</code>	Masks the video on the specified output(s)
<code>#show_mask</code>	Displays the current masking status of each output
<code>#unmask</code>	Unmasks the specified outputs

#mask

The `#mask` command masks the video on the specified output(s). If `param1 = 0`, then all outputs are masked. Use the `#unmask` command to disable output masking.

Syntax

```
#mask param1
```

Parameters

param1 Output [0 ... 2]

Example

```
#mask 1  
OUTPUT 1 IS MASKED
```

#show_mask

The `#show_mask` command displays the mask status of the specified output.

Syntax

```
#show_mask param1
```

Parameters

<i>param1</i>	Output	[1 ... 2]
---------------	--------	-----------

Example

```
#show_mask 1
OUTPUT 1 ARE MASKED
```

#unmask

The `#unmask` command unmask the specified output(s). Use the `#mask` command to mask the specified output(s). If *param1* = 0, then all outputs are unmasked.

Syntax

```
#unmask param1
```

Parameters

<i>param1</i>	Output	[0 ... 2]
---------------	--------	-----------

Example

```
#unmask 1
OUTPUT 1 IS UNMASKED
```

Routing / Naming / +5V / Presets

Command	Description
<code>#lock_matrix</code>	Locks / unlocks the matrix
<code>#recall_preset</code>	Loads the specified routing state
<code>#save_preset</code>	Saves the current routing state to a preset
<code>#set_bank_name</code>	Assigns a name to the specified EDID bank
<code>#set_input_name</code>	Assigns a name to the specified input
<code>#set_output_name</code>	Assigns a name to the specified output
<code>#set_preset_name</code>	Assigns a name to the specified preset
<code>#show_bank_name</code>	Displays the name for the specified EDID bank
<code>#show_input_name</code>	Displays the name of the specified input
<code>#show_output_name</code>	Displays the name of the output
<code>#show_preset_name</code>	Displays the name of the specified preset
<code>#show_r</code>	Displays the routing status of the output
<code>r</code>	Routes the specified input to the output

#lock_matrix

The #lock_matrix command locks / unlocks the matrix. When the matrix is locked, all functions are disabled including the front panel, RS-232, and Telnet.

Syntax

```
#lock_matrix param1
```

Parameters

param1 Value [0 ... 1]

Value	Description
0	Unlock
1	Lock

Example

```
#lock_matrix 1  
MATRIX IS LOCKED
```

#recall_preset

The #recall_preset command loads the routing preset.

Syntax

```
#recall_preset param1
```

Parameters

<i>param1</i>	Preset	[1 ... 8]
---------------	--------	-----------

Example

```
#recall_preset 2
RECALLED THE ROUTING STATE SAVED TO PRESET 2
```

#save_preset

The #save_preset command saves the current routing state to a specified preset.

Syntax

```
#save_preset param1
```

Parameters

<i>param1</i>	Preset	[1 ... 8]
---------------	--------	-----------

Example

```
#save_preset 3
CURRENT ROUTING STATE IS SAVED TO PRESET 3
```

#set_bank_name

The #set_bank_name command names the specified bank.

Syntax

```
#set_bank_name param1 param2
```

Parameters

<i>param1</i>	Bank	[1 ... 8]
<i>param2</i>	Name	

Example

```
#set_bank_name 5 Dell24  
Dell24 NAME IS ASSIGNED TO BANK 5
```

#set_input_name

The #set_input_name command assigns a name to the specified input on the matrix.

Syntax

```
#set_input_name param1 param2
```

Parameters

<i>param1</i>	Input	[1 ... 6]
<i>param2</i>	Name	

Example

```
#set_input_name 3 Blu-ray  
Blu-ray NAME IS ASSIGNED TO INPUT 3
```

#set_output_name

The `#set_output_name` command assigns a name to the output on the matrix. The name of the output is limited to 15 characters. Names longer than 15 characters will be truncated. To name an output, use the `#set_output_name` command.

Syntax

```
#set_output_name param1 param2
```

Parameters

<i>param1</i>	Output	[1 ... 2]
<i>param2</i>	Name	

Example

```
#set_output_name 2 Sony_XBR  
Sony_XBR NAME IS ASSIGNED TO OUTPUT 2
```

#set_preset_name

The `#set_preset_name` command assigns a name to the specified preset. The name of the preset is limited to 8 characters. To display the name of a preset, use the `#show_preset_name` command.

Syntax

```
#set_preset_name param1 param2
```

Parameters

<i>param1</i>	Preset	[1 ... 8]
<i>param2</i>	Name	

Example

```
#set_preset_name 4 DVD2Out2  
DVD2Out2 NAME IS ASSIGNED TO PRESET 4
```

#show_bank_name

The #show_bank_name command displays the name for the specified EDID bank. To name an EDID bank, use the #set_bank_name command.

Syntax

```
#show_bank_name param1
```

Parameters

<i>param1</i>	Bank	[1 ... 8]
---------------	------	-----------

Example

```
#show_bank_name 5  
THE NAME FOR BANK 5 IS: Dell24
```

#show_input_name

The #show_input_name command displays the name of the specified input. To name an input, use the #set_input_name command.

Syntax

```
#show_input_name param1
```

Parameters

<i>param1</i>	Input	[1 ... 6]
---------------	-------	-----------

Example

```
#show_input_name 3  
THE NAME FOR INPUT 3 IS: Blu-ray
```

#show_output_name

The #show_output_name command displays the name of the output. To name an output, use the #set_output_name command.

Syntax

```
#show_output_name param1
```

Parameters

<i>param1</i>	Output	[1 ... 2]
---------------	--------	-----------

Example

```
#show_output_name 2  
THE NAME FOR OUTPUT 2 IS: Sony_XBR
```

#show_preset_name

The #show_preset_name command displays the name for the specified preset. To assign a name to a preset, use the #set_preset_name command.

Syntax

```
#show_preset_name param1
```

Parameters

<i>param1</i>	Preset	[1 ... 8]
---------------	--------	-----------

Example

```
#show_preset_name 4  
THE NAME FOR PRESET 4 IS: DVD2Out2
```

#show_r

The #show_r command displays the current routing status of the output. The name of the output and input are displayed.

Syntax

```
#show_r param1
```

Parameters

<i>param1</i>	Output	[1 ... 2]
---------------	--------	-----------

Example

```
#show_r 2  
OUTPUT 2 IS ROUTED TO VIDEO INPUT 2
```

r

The `r` command routes the specified input to the output. Do not precede this command with the “#” symbol. Also see the `s` command. If `param2 = 0`, then the specified input (`param1`) will be routed to all outputs. `param3` is optional but can be used to specify another output on the command line.

Syntax

```
r param1 param2 [param3]
```

Parameters

<i>param1</i>	Input	[1 ... 6]
<i>param2</i>	Output	[0 ... 2]
<i>param3</i>	Output	[1 ... 2]

Example

```
r 3 1 2
```

```
INPUT 3 IS ROUTED TO OUTPUTS 1 2
```

Status

Command	Description
<code>#help</code>	Displays a list of available RS-232 / Telnet commands
<code>#show_fw</code>	Displays the current version of firmware
<code>#show_hpd</code>	Displays the HPD status of the specified input
<code>#show_rsense</code>	Displays the RSENSE status of the output
<code>m</code>	Displays the current routing status of the matrix

#help

The `#help` command displays the list of available RS-232 / Telnet commands. Help on a specific command can be displayed when using `param1`.

Syntax

```
#help param1
```

Parameters

param1 Command name (optional)

Example

```
#help #sipadd
```

```
#SIPADD PARAM 1  
SET THE IP ADDRESS  
PARAM 1 = XXX.XXX.XXX.XXX  
WHERE XXX: 0 - 255
```

#show_fw

The #show_fw command displays the current version of matrix firmware.

Syntax

```
#show_fw
```

Parameters

None

Example

```
#show_fw
FIRMWARE VERSION : V1.0G
```

#show_hpd

The #show_hpd command displays the HPD status of the specified output. The name of the output is included.

Syntax

```
#show_hpd param1
```

Parameters

<i>param1</i>	Output	[1 ... 2]
---------------	--------	-----------

Example

```
#show_hpd 2
HPD OF OUTPUT 1 IS HIGH
```

#show_rsense

The #show_rsense command displays the RSENSE status of the specified output.

Syntax

```
#show_rsense param1
```

Parameters

<i>param1</i>	Output	[1 ... 2]
---------------	--------	-----------

Example

```
#show_rsense 2  
RSENSE OF OUTPUT 1 IS HIGH
```

m

The `m` command displays the current routing status of the matrix. Masking and locking status of the matrix is also provided. Do not precede the `m` command with the '#' symbol.

Syntax

```
m
```

Parameters

None

Example

```
m
```

```
OUTPUT 1 IS ROUTED TO INPUT 3  
OUTPUT 2 IS ROUTED TO INPUT 3  
OUTPUT 1 2 ARE UNMASKED  
MATRIX IS UNLOCKED
```

Web Interface

Using the built-in Web Server

Access the built-in Web interface by entering the IP address of the matrix that was specified in step 3 under [IP / UDP Configuration](#). Once connected to the matrix, the login screen will be displayed.

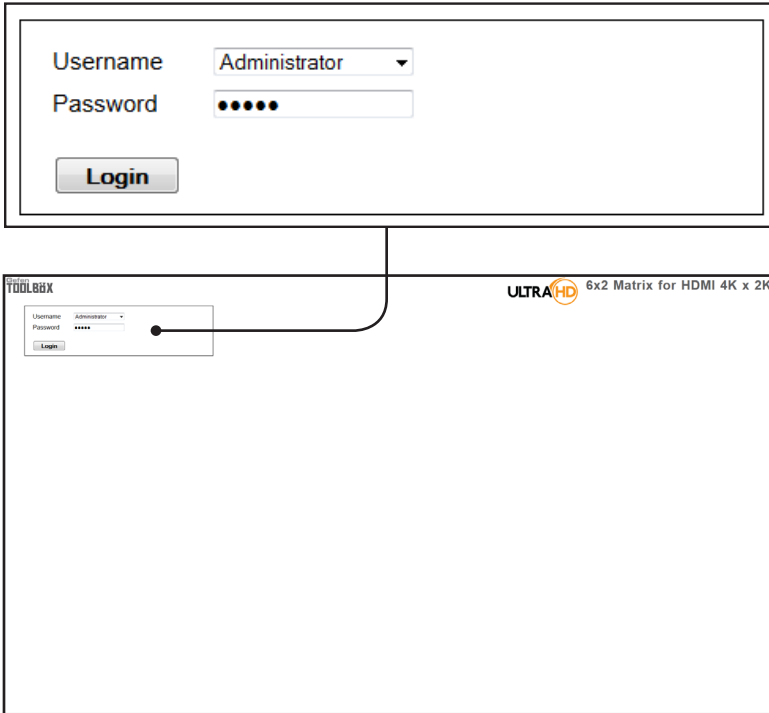

Username

Select the username from the drop-down list.

Options:

Operator, Administrator

Administrator login provides unrestricted access to all features and settings. Operator login limits access to matrix routing, display information, and routing preset features.

Password

Enter the password for the associated username. The password can also be set using RS-232 or Telnet. See the [#set_webui_op_pass](#) and the [#set_webui_ad_pass](#) commands. The password is masked when it is entered. The default password for both user names is Admin.

The Web GUI is divided into four main pages: **Main**, **I/O Setup**, **Manage EDID**, and **Configuration**. Each main page is represented by a tab at the top-most portion of the screen. The **Main**, **I/O Setup**, and **Manage EDID** pages have their own set of sub-tabs. Click on the desired tab / sub-tab to open the desired page.



NOTE: In order to view all four tabs at the top of the screen, the user must be logged in as “Administrator”. If logged-in as “Operator”, only the **Main** tab will be visible.

Main Routing

Log Out

Click **Log Out** to terminate the current Web session and return to the login page.

Log Out

The screenshot shows the TOOLBOX web interface for a 6x2 Matrix for HDMI 4K x 4K. The 'Routing' page is active, displaying a 'Status' table and a table of 'Outputs' and 'Inputs'. A callout box highlights the 'Status' table.

Status	
Output	Input #
1	1
2	2

Output

The number of outputs that are available for routing.

Input

The input that is currently routed to the output.

The screenshot shows the TOOLBOX web interface for a 6x2 Matrix for HDMI 4K x 2K. The interface is divided into several sections:

- Navigation:** Main, I/O Setup, Manage EDDID, Configuration, Routing, I/O Status, Display Info.
- Status:** A table with columns 'Output' and 'Input #'. It shows two rows: (1, 1) and (2, 2).
- Outputs:** A table with columns 'Name' and 'Output'. It lists OUTPUT1 (Output 1) and OUTPUT2 (Output 2). A 'Route' button is located below this table.
- Inputs:** A table with columns 'Input #' and 'Name'. It lists INPUT1 through INPUT6, and a 'Mask / Unmask' option. A 'Route' button is located below this table.
- Save & Recall Routing Presets:** A section for saving and recalling routing configurations.

Name (Outputs)

The name of the output.

This name can be changed using the `#set_output_name` command or through the [I/O Setup ► I/O Names](#) page of the Web interface.

Outputs (Outputs)

Check to select the currently active output.

Input # (Inputs)

Click the radio button next to the desired input to be routed.

Name (Inputs)

Displays the current name of the input.

This name can be changed using the `#set_input_name` command or through the [I/O Setup ► I/O Names](#) page of the Web interface.

Route

Click the **Route** button to route the selected input to the select output(s).

Lock Matrix

Locks / unlocks the matrix. Once the matrix is locked, settings cannot be changed using the front-panel buttons or through the Web GUI. When the matrix is locked, the button text will read "Unlock Matrix" and a red bar will appear across the top portion of the screen with the text "Matrix is LOCKED". Click the "Unlock Matrix" button to unlock the matrix.

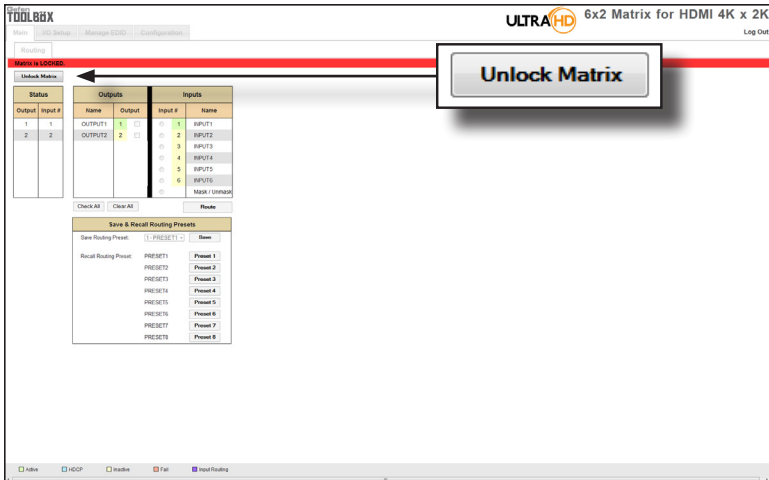
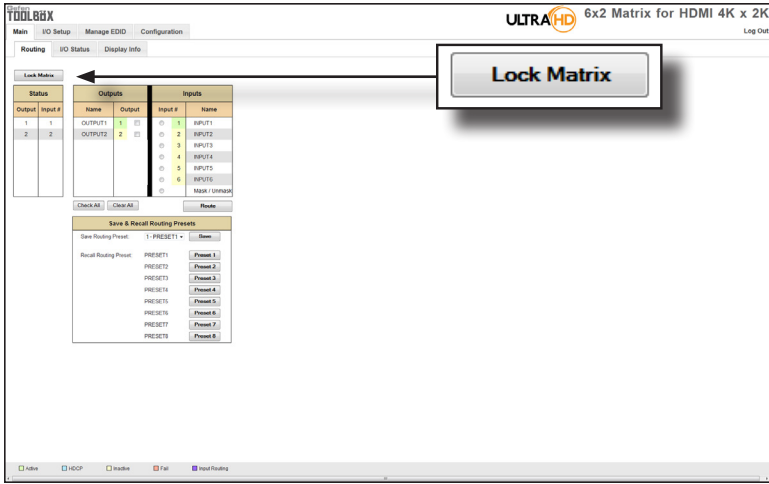

Main I/O Status

The screenshot shows the TDBOX web interface with the 'I/O Status' page selected. The page title is 'ULTRAHD 6x2 Matrix for HDMI 4K x 2K'. The main content area displays a table for 'Output' configuration. A callout box provides a detailed view of the output status for two outputs, labeled '1' and '2'.

Output		
	1	2
Name	OUTPUT1	OUTPUT2
RSENSE	On	Off
Mask	Off	Off
HPD	High	Low
HDCP	Inactive	Inactive
Video Mode	DVI	DVI

Output

Displays the state of each output for each of the following: Name, RSENSE, Mask, HPD (Hot-Plug Detect), HDCP, and Video Mode.

Name

Displays the name of the output. The name of the output can be changed using the `#set_output_name` command or through the **I/O Setup** ► **I/O Names** page of the Web interface.

RSENSE

Displays the current Rsense state.

Mask

Displays the masking state of each output.

HPD

Displays the Hot-Plug Detect (HPD) state of each output.

HDCP

Indicates if HDCP-detection is enabled or disabled on each output.

Video Mode

Displays the current output video mode.

TOOLBOX ULTRA HD 6x2 Matrix for HDMI 4K x 2K Log Out

Menu: [iD Setup](#) [Manage EDD](#) [Configuration](#)

Routing | **I/O Status** | Display Info

Output		
	1	2
Name	OUTPUT1	OUTPUT2
SENSE	On	On
Link	On	On
ED	High	Low
HDCP	Inactive	Inactive
Video Mode	DVI	DVI

Input						
	1	2	3	4	5	6
Name	INPUT1	INPUT2	INPUT3	INPUT4	INPUT5	INPUT6
Color Depth	8bit	-	-	-	-	-
Color Space	RGB	-	-	-	-	-
HDCP	No	No	No	No	No	No
3D	No	No	No	No	No	No
Active Signal	Yes	No	No	No	No	No
Vertical Resolution	720	-	-	-	-	-
Horizontal Resolution	1280	-	-	-	-	-
Progressive / Interlaced	p	-	-	-	-	-
Refresh Rate	-	-	-	-	-	-
Video Mode	HDMI	DVI	DVI	DVI	DVI	DVI

Input					
	1	2	3	4	IN
Name	INPUT1	INPUT2	INPUT3	INPUT4	IN
Color Depth	8bit	-	-	-	-
Color Space	RGB	-	-	-	-
HDCP	No	No	No	No	N
3D	No	No	No	No	N
Active Signal	Yes	No	No	No	N
Vertical Resolution	720	-	-	-	-
Horizontal Resolution	1280	-	-	-	-
Progressive / Interlaced	p	-	-	-	-
Refresh Rate	-	-	-	-	-
Video Mode	HDMI	DVI	DVI	DVI	D

Input

Displays the state of each input for each of the following: Input name, Color Depth, Color Space, HDCP, 3D, Active Signal, Vertical Resolution, Horizontal Resolution, Progressive / Interlaced, Refresh Rate, and Video Mode.

Main Display Info

Choose EDID 1 - BANK1

TOOLBOX 6x2 Matrix for HDMI 4K x 2K

Main I/O Setup Manage EDID Configuration

Routing I/O Status **Display Info**

Choose EDID 1 - BANK1

Feature	
24Hz Frame Rate	TRUE
Max Resolution	1080P@60Hz
Max Color Depth	8 bit
3D Capable	FALSE
Mode (DVI/HDMI)	HDMI
Max Audio Channels	2 Ch
Monitor Name	HDMI-DA

Audio Formats	
LPCM	TRUE
DTS-HD	FALSE
DTS Digital Surround	FALSE
Dolby Digital (AC3)	FALSE
Dolby TrueHD	FALSE

Choose EDID

Select the EDID from the drop-down list. The selected EDID will be copied from the Output or selected EDID Bank to the desired input(s) and used by the source.

Options
Bank 1 ... Bank 8
Output 1 ... Output 2

Feature / Audio Formats

Displays the capabilities of the display (or sink device), based on the EDID.

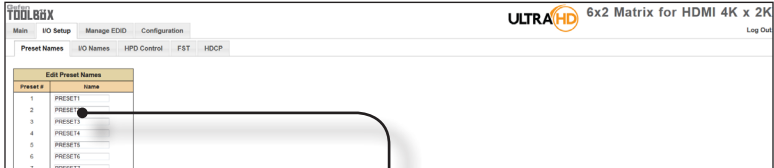
I/O Setup Preset Names

Edit Preset Names	
Preset #	Name
1	<input type="text" value="PRESET1"/>
2	<input type="text" value="PRESET2"/>
3	<input type="text" value="PRESET3"/>
4	<input type="text" value="PRESET4"/>
5	<input type="text" value="PRESET5"/>
6	<input type="text" value="PRESET6"/>
7	<input type="text" value="PRESET7"/>
8	<input type="text" value="PRESET8"/>

Preset #

The number of each preset.

Name

Type the desired name of each preset in these fields.

Save Changes

Saves the current changes to the name of the preset(s).

Cancel

Restores the previous name or each preset, if a change was made.

I/O Setup □ I/O Names

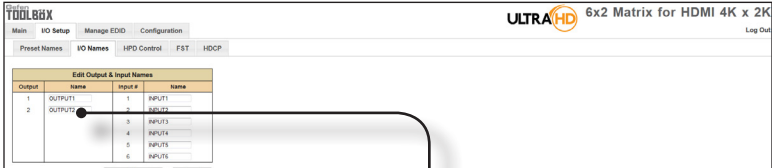

Edit Output & Input Names			
Output	Name	Input #	Name
1	<input type="text" value="OUTPUT1"/>	1	<input type="text" value="INPUT1"/>
2	<input type="text" value="OUTPUT2"/>	2	<input type="text" value="INPUT2"/>
		3	<input type="text" value="INPUT3"/>
		4	<input type="text" value="INPUT4"/>
		5	<input type="text" value="INPUT5"/>
		6	<input type="text" value="INPUT6"/>

Output

The number of the output.

Name (Output)

Type the desired name of each output in these fields.

Input #

The number of each input.

Name (Input #)

Type the desired name of each the input in these fields.

Save Changes

Saves the current changes to the name of the output and/or input(s).

Cancel

Restores the previous name or each output and/or input(s), if a change was made.

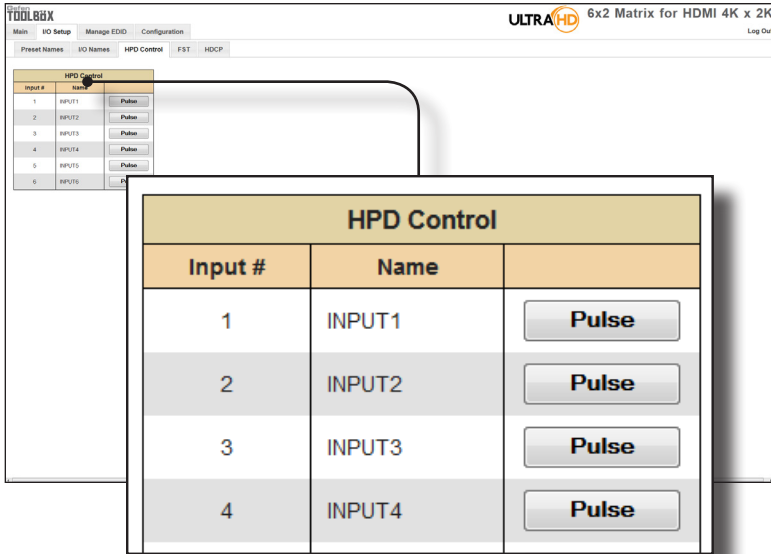
I/O Setup HPD Control**Input #**

The number of the input.

Name

The name of the input. The name of each input can be changed using the `#set_input_name` command or through the I/O Setup ► I/O Names page of the Web interface.

Pulse

Click the Pulse button to cycle the HPD line on the desired input. This is the equivalent of physically disconnecting and reconnecting the HDMI cable between the source device and the matrix.

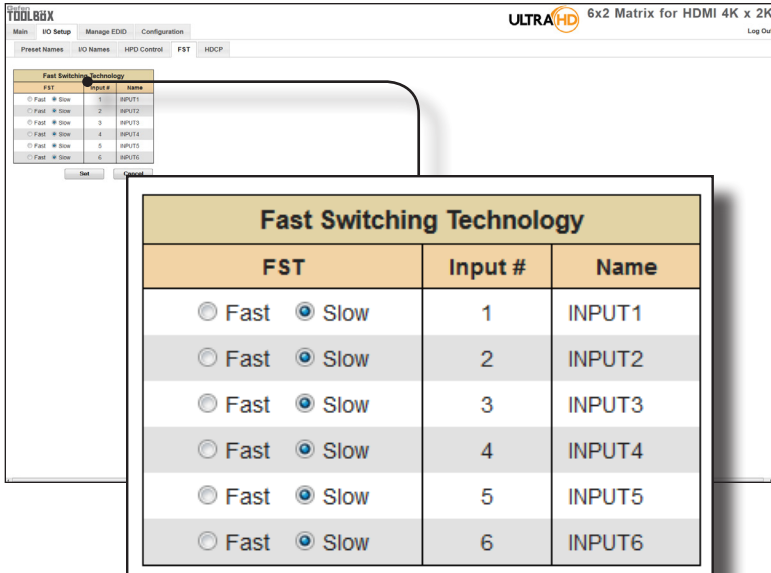
I/O Setup FST

The screenshot shows the TOOLBOX web interface. The top navigation bar includes 'Main', 'I/O Setup', 'Manage EDD', and 'Configuration'. The 'I/O Setup' page is active, with sub-tabs for 'Preset Names', 'I/O Names', 'HPD Control', 'FST', and 'HDCP'. The 'FST' section is highlighted, showing a table with columns 'FST', 'Input #', and 'Name'. The table lists six inputs, each with 'Fast' and 'Slow' radio buttons. The 'Slow' option is selected for all inputs.

Fast Switching Technology		
FST	Input #	Name
<input type="radio"/> Fast <input checked="" type="radio"/> Slow	1	INPUT1
<input type="radio"/> Fast <input checked="" type="radio"/> Slow	2	INPUT2
<input type="radio"/> Fast <input checked="" type="radio"/> Slow	3	INPUT3
<input type="radio"/> Fast <input checked="" type="radio"/> Slow	4	INPUT4
<input type="radio"/> Fast <input checked="" type="radio"/> Slow	5	INPUT5
<input type="radio"/> Fast <input checked="" type="radio"/> Slow	6	INPUT6

FST

Displays the switching state of each input.

Input #

The name of the input.

Name

The name of the input. The name of each input can be changed using the `#set_input_name` command or through the [I/O Setup](#) ► [I/O Names](#) page of the Web interface.

I/O Setup HDCP

NOTE: Some computers will enable HDCP if an HDCP-compliant display is detected. Check the box under the Disable column to force the computer to ignore detection of an HDCP-compliant display. The Disable feature does *not* decrypt HDCP content.

HDCP Pass Through		
Disable	Input #	Name
<input type="checkbox"/>	1	INPUT1
<input type="checkbox"/>	2	INPUT2
<input type="checkbox"/>	3	INPUT3
<input type="checkbox"/>	4	INPUT4
<input type="checkbox"/>	5	INPUT5
<input type="checkbox"/>	6	INPUT6

Disable

Check the box under the Disable column to force the computer to ignore HDCP-detection.

Input #

The number of the input.

Name

The name of the input. The name of each input can be changed using the [#set_input_name](#) command or through the [I/O Setup ► I/O Names](#) page of the Web interface.

Check All

Places a check mark in all boxes under the Disable column.

Clear All

Clears all check marks from the Disable column.

Set

Click this button to save changes for all input(s).

Cancel

Cancels the current operation and ignores changes for each input, if a change was made.

Manage EDID Assign

Lock EDID

Secures the Local EDID and disables automatic EDID loading during power-up.

If the **Lock EDID** button is clicked (enabled), the “EDID locked on power cycle” message will be displayed in red. The local EDID information will now be locked once the matrix is rebooted. Click the **Unlock EDID** button to disable the Lock EDID feature.

The screenshot shows the 'TOOLBOX' web interface for EDID management. At the top, there are navigation tabs: 'Main', 'I/O Setup', 'Manage EDID', and 'Configuration'. The 'Manage EDID' tab is active, showing sub-tabs for 'Assign', 'Bank Names', and 'Upload/Download'. A 'Lock EDID' button is highlighted with a callout box. Below it, an 'Unlock EDID' button is shown next to a red banner that reads 'EDID locked on power cycle.'. The main interface area displays a 'Copy EDID From' dropdown menu set to '1 - BANK1'. Below this, there are two tables: 'Inputs' and 'Banks'. The 'Inputs' table lists EDID sources like 'External-Output' and 'EDID Source'. The 'Banks' table lists EDID banks like 'BANK1' through 'BANK8' with their respective EDID names.

Copy To	EDID Source	Input #	Name	EDID Source	EDID Name
<input type="checkbox"/>	External-Output	1	INPUT1	Ed EDID(OUT 1)	DELL E2010n
<input type="checkbox"/>	External-Output	2	INPUT2	Ed EDID(OUT 1)	DELL E2010n
<input type="checkbox"/>	External-Output	3	INPUT3	Ed EDID(OUT 1)	DELL E2010n
<input type="checkbox"/>	External-Output	4	INPUT4	Ed EDID(OUT 1)	DELL E2010n
<input type="checkbox"/>	External-Output	5	INPUT5	Ed EDID(OUT 1)	DELL E2010n
<input type="checkbox"/>	External-Output	6	INPUT6	Ed EDID(OUT 1)	DELL E2010n

Copy To	Input #	Name	EDID Name
<input type="checkbox"/>	1	BANK1	DTX-45.4
<input type="checkbox"/>	2	BANK2	SEC0Y164
<input type="checkbox"/>	3	BANK3	N/A
<input type="checkbox"/>	4	BANK4	Panasonic TVS
<input type="checkbox"/>	5	BANK5	N/A
<input type="checkbox"/>	6	BANK6	N/A
<input type="checkbox"/>	7	BANK7	N/A
<input type="checkbox"/>	8	BANK8	Panasonic TVS

Copy EDID From

Select the EDID from the drop-down list. The EDID will be copied from the Output or selected EDID bank to the destination

Options	
Bank 1	... Bank 8
Output 1	... Output 2

Inputs				
Copy To	EDID Modes	Input #	Name	EDID
<input type="checkbox"/>	External - Output1	1	INPUT1	Ext EDI
<input type="checkbox"/>	External - Output1	2	INPUT2	Ext EDI
<input type="checkbox"/>	External - Output1	3	INPUT3	Ext EDI
<input type="checkbox"/>	External - Output1	4	INPUT4	Ext EDI

Assign Bank Names Upload/Download

Link EDID

Copy EDID From: (Bank) ▼

Copy EDID To: Please select from the Inputs/Banks below

Copy To	EDID Modes	Input #	Name	EDID Source	EDID Name
<input type="checkbox"/>	External - Output1	1	INPUT1	Ext EDID(OUT 1)	DELL E2010H
<input type="checkbox"/>	External - Output1	2	INPUT2	Ext EDID(OUT 1)	DELL E2010H
<input type="checkbox"/>	External - Output1	3	INPUT3	Ext EDID(OUT 1)	DELL E2010H
<input type="checkbox"/>	External - Output1	4	INPUT4	Ext EDID(OUT 1)	DELL E2010H
<input type="checkbox"/>	External - Output1	5	INPUT5	Ext EDID(OUT 1)	DELL E2010H
<input type="checkbox"/>	External - Output1	6	INPUT6	Ext EDID(OUT 1)	DELL E2010H

Check All Clear All

Copy To	Input #	Bank #	Name	EDID Name
<input type="checkbox"/>	1	BANK1	DTR-40 X	
<input type="checkbox"/>	2	BANK2	SEC0104	
<input type="checkbox"/>	3	BANK3	N/A	
<input type="checkbox"/>	4	BANK4	ParasenseTV2	
<input type="checkbox"/>	5	BANK5	N/A	
<input type="checkbox"/>	6	BANK6	N/A	
<input type="checkbox"/>	7	BANK7	N/A	
<input type="checkbox"/>	8	BANK8	ParasenseTV2	

Check All Clear All Copy Cancel

Copy To

Place a check mark in the desired check box to select or deselect the desired input(s). These check-boxes can only be used when the EDID Mode is set to Custom - User.

EDID Modes

Select the EDID mode from the drop-down list.

Options
Internal - 1080p 2 ch audio
Internal - 1080p Multi ch
External - Output1
Custom - Last Output
Custom - User

See the next page for more information on using EDID Modes.

Internal - 1080p 2 ch audio

This mode can be used as a generic EDID. Resolutions up to 1080p Full HD are supported along with 2-channel audio.

Internal - 1080p Multi ch

Same as above except with multichannel audio support.

External - Output1

Uses the (downstream) EDID of the sink device connected to Output 1.

Custom - Last Output

Uses the EDID from the last output on the matrix. For example, this matrix has a total of two outputs. If a sink device is connected to *both* **Out 1** and **Out 2**, then the matrix will use the EDID from the sink that is connected to **Out 2**. Likewise, if a sink device is connected *only* to **Out 2**, then the EDID from **Out 2** will be used. Alternatively, if a sink device is connected *only* to **Out 1**, then the EDID from **Out 1** will be used.

Custom - User

Used to select an EDID from the desired bank and copy it to an input. To do this, select the bank from the **Copy EDID From** drop-down list. Next, select **Custom - User** for the desired input, under the **EDID Modes** column. Finally, place a check mark in the **Copy To** check box, then click the **Copy** button.

Inputs				
Modes	Input #	Name	EDID Source	EDID Name
put1 ▼	1	INPUT1	Ext EDID(OUT 1)	DELL E2010H
put1 ▼	2	INPUT2	Ext EDID(OUT 1)	DELL E2010H
put1 ▼	3	INPUT3	Ext EDID(OUT 1)	DELL E2010H
put1 ▼	4	INPUT4	Ext EDID(OUT 1)	DELL E2010H

Input #

The number of the input.

Name

The name of the input. The name of the input can be changed using the `#set_input_name` command or through the [I/O Setup ► I/O Names](#) page of the Web interface.

EDID Source

The current EDID source being used.

EDID Name

The name of the EDID.

Clear All

Clears all check marks from the **Copy To** column.

Manage EDID Bank Names

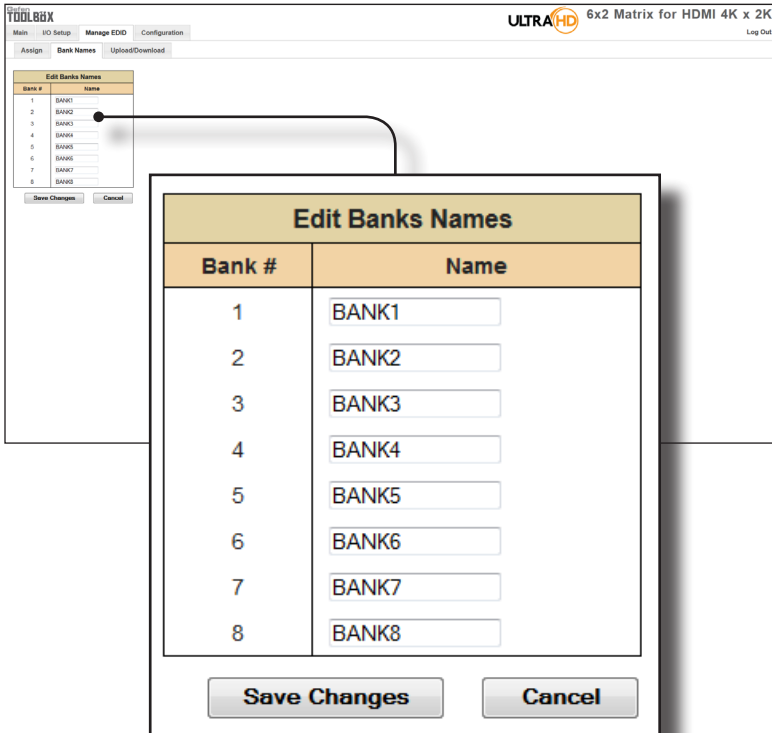

Bank

Indicates the EDID bank number.

Name

Type the desired name of the EDID bank in this field.

Save Changes

Saves the current name change to the EDID bank(s).

Cancel

Restores the previous names for each EDID bank, if changes were made.

Manage EDID Upload/Download

Browse...

Click this button to select the EDID file to be uploaded.

Select Bank Location

Click this drop-down list to select the bank to where the EDID will be uploaded.

Options
1 - Bank1 ... 8 - Bank8

Upload

Click this button to upload the EDID to the specified bank.

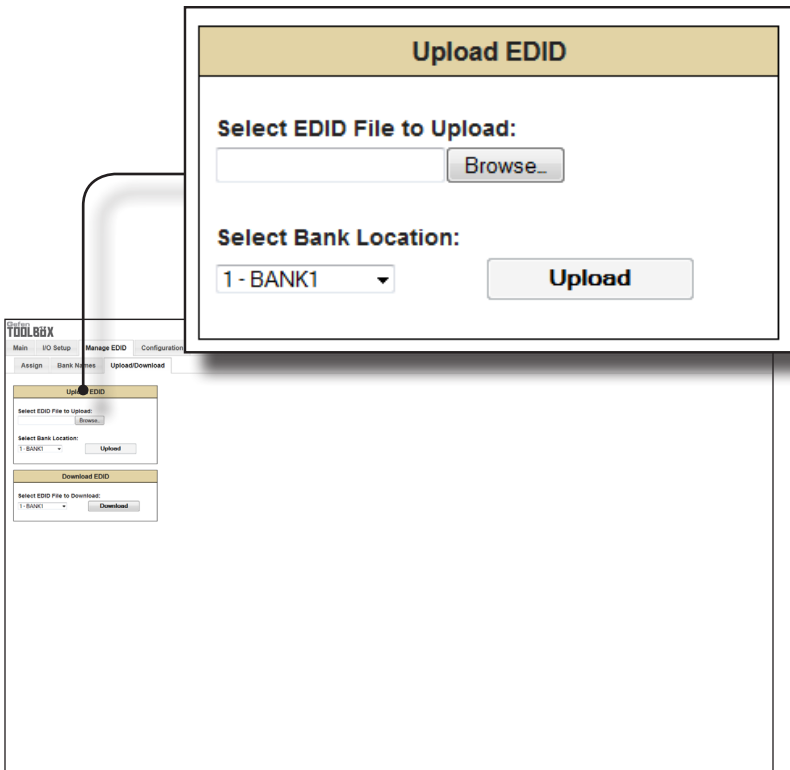

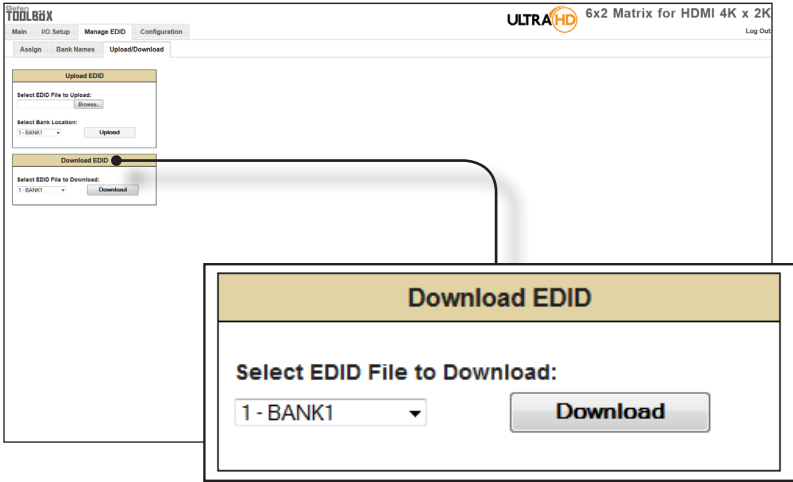

Select EDID File to Download

Click this box to select the EDID that is to be saved to a file. The EDID file will be saved in binary (.bin) format.

Options	
1 - BANK1 ... 8 - BANK8	
1 - OUTPUT1 ... 2 - OUTPUT2	
1 - INPUT1 ... 6 - INPUT4	

Download

Click this button to download the selected EDID to a file.

Configuration Change IP Settings

The screenshot shows a web interface for a device. At the top, there is a navigation menu with 'Main', 'IO Setup', 'Manage EDD', and 'Configuration'. The 'Configuration' menu is active. The main content area displays the 'Change IP Settings' dialog box. The dialog has a title bar and a list of settings:

Setting	Value
MAC Address:	10:12:34:56:79:aa
IP Address:	192.168.2.190
Subnet:	255.255.255.0
Gateway:	192.168.2.1
Port:	80
TCP/Telnet Terminal Port:	23
UDP Port:	50007

At the bottom of the dialog, there are two buttons: 'Save Settings' and 'Set Defaults'.

Change IP Settings

Assigns the IP address, subnet, gateway, HTTP listening port, Telnet port, and UDP port. The MAC address cannot be changed.

Save Settings

Saves the current settings for the Change IP Settings. After clicking this button, the Web interface will display a dialog indicating that the matrix must be rebooted for changes to take effect.

Set Defaults

Click this button to restore the factory-default IP settings. After clicking this button, the Web interface will display a dialog indicating that the matrix must be rebooted for changes to take effect.

Configuration Telnet Login Settings

The screenshot shows the 'Telnet Login Settings' configuration page. The page is titled 'Telnet Login Settings' and contains several sections: 'Change IP Settings', 'Telnet Login Settings', and 'UDP Connection Settings'. The 'Telnet Login Settings' section is highlighted with a callout box. The callout box shows the following fields: 'Old Password' (text input), 'New Password' (text input), 'Confirm New Password' (text input), 'Force Password on Connect' (checkbox, unchecked), and 'Show Login Message on Connect' (checkbox, checked). A 'Save Settings' button is located at the bottom right of the callout box.

Old Password

Type the current (old) password in this field.

New Password

Type the new password in this field.

Force Password on Connect

Click this check box to have the matrix prompt for a password each time a Telnet session is started. This box *must* be checked in order to change the Telnet Login credentials.

Show Login Message on Connect

Click this check box to have the matrix display the Telnet welcome message each time a Telnet session is started. The welcome message appears as: "Welcome to GTB-HD4K2K-442 TELNET".

Save Settings

Saves the current changes to the Telnet Login Settings.

Configuration UDP Connection Settings

The screenshot shows the 'TOOLBOX' web interface with the 'Configuration' tab selected. The 'UDP Connection Settings' section is highlighted with a callout box. The callout box contains the following settings:

UDP Connection Settings	
Remote UDP IP Address:	<input type="text" value="192.168.1.255"/>
Remote UDP Port:	<input type="text" value="50008"/>
Enable UDP Access:	<input type="checkbox"/>

A 'Save Settings' button is located at the bottom right of the callout box.

Remote UDP IP Address

Type the remote UDP IP address in this text box.

Remote UDP Port

Enter the remote UDP port in this text box.

Enable UDP Access

Check this box to enable UDP access. If this box is unchecked, the UDP access will be unavailable.

Configuration □ Web Login Settings

Web Login Settings

Username: Operator ▾

Old Password: ●●●●●

New Password:

Confirm New Password:

Telnet Login Settings

Old Password:

New Password:

Confirm New Password:

Force Password on Connect:

Show Login Message on Connect:

UDP Connection Settings

Remove UDP IP Address:

Remove UDP Port:

Enable UDP Access:

Web Login Settings

Username: Operator ▾

Old Password: ●●●●●

New Password:

Confirm New Password:

System Configuration

Download Current Configuration

Restore Configuration

Warning: All current settings will be lost.

Firmware Update (Firmware: V1.0)

IR Channel:

Factory Reset

Reboot

Username

Click this drop-down list to select the user name. The credentials for the selected user name can now be changed.

Old Password

Type the current (old) password in this field.

New Password

Type the new password in this field.

Confirm Password

Re-type the new password in this field.

Save Settings

Saves the current changes to the Web Login Settings.

Configuration System Configuration

System Configuration

Download Current Configuration	<input type="button" value="Download"/>
Restore Configuration	<input type="button" value="Browse..."/>
<i>Warning: All current settings will be lost</i>	<input type="button" value="Restore"/>
Firmware Update (UI ver: V1.0)	<input type="button" value="Browse..."/>
	<input type="button" value="Update"/>
IR Channel <input type="text" value="0"/>	<input type="button" value="Save"/>
Factory Reset	<input type="button" value="Reset"/>
Reboot	<input type="button" value="Reboot"/>

UDP Connection Settings

Remote UDP IP Address:	<input type="text" value="192.168.1.255"/>
Remote UDP Port:	<input type="text" value="8080"/>
Enable UDP Access:	<input type="checkbox"/>

Web Login Settings

Username:	<input type="text" value="Operator"/>
Old Password:	<input type="password" value="*****"/>
New Password:	<input type="password"/>
Confirm New Password:	<input type="password"/>

System Configuration

Download Current Configuration	<input type="button" value="Download"/>
Restore Configuration	<input type="button" value="Browse..."/>
<i>Warning: All current settings will be lost</i>	<input type="button" value="Restore"/>
Firmware Update (UI ver: V1.0)	<input type="button" value="Browse..."/>
	<input type="button" value="Update"/>
IR Channel <input type="text" value="0"/>	<input type="button" value="Save"/>
Factory Reset	<input type="button" value="Reset"/>
Reboot	<input type="button" value="Reboot"/>

Download

Click this button to download the current matrix configuration to a file.

(continued on next page)

System Configuration

Download Current Configuration

Restore Configuration

Warning: All current settings will be lost

Firmware Update (UI ver: V1.0)

IR Channel

Factory Reset

Reboot

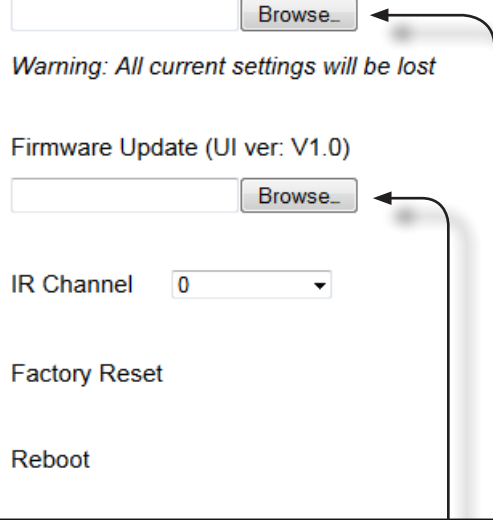
**Browse**

Click this button to select the firmware file to be uploaded. See [Upgrading using the Web interface](#) for details on updating the firmware.

Browse

Click this button to select the saved configuration file to be loaded into memory.

Restore

Uploads the selected configuration file to the matrix.

Update

Updates the matrix with the selected firmware file.

System Configuration

Download Current Configuration

Restore Configuration

Warning: All current settings will be lost

Firmware Update (UI ver: V1.0)

IR Channel 0

Factory Reset

Reboot

Download

Browse...

Restore

Update

Save

Reset

Reboot

IR Channel

Click this drop-down list to set the desired IR channel for the matrix. Note that the matrix and the included IR remote control must be set to the same channel in order to work properly. The IR channel for the matrix can also be set using the `#set_ir` command.

Options

0 ... 3

Save

Click this button to save any changes made to the IR channel setting.

Reset

Click this button to set the matrix to factory-default settings. The IP settings are preserved.

Reboot

Click this button to reboot the matrix.

4K ULTRA HD

6x2
SOURCES DISPLAYS

**Matrix for HDMI
with Ultra HD
4K x 2K support**

04 Appendix

Wall Mounting Instructions	106
Firmware Upgrade Procedure	107
Upgrading using the Web interface	107
Upgrading using the USB port	108
Specifications	109

Wall Mounting Instructions

The 6x2 Matrix for HDMI 4K x 2K should be mounted vertically in a wall or cabinet with wood/drywall screws as shown in the diagram above. There should be an inch or two of clearance between the edges of the unit and any walls or vertical surfaces to allow for enough clearance for insertion and retraction of cables at the HDMI connectors.

For installation on a drywall surface, use a #6 drywall screw. It is recommended when installing on a drywall surface that studs be used to secure the matrix should undue stress be applied when connecting and disconnecting HDMI cables.



Firmware Upgrade Procedure

The firmware for the 6x2 Matrix for HDMI 4K x 2K can be upgraded using any one of the following methods: 1) Using the Web interface. 2) Using the USB port. The first method is covered below. See the next page for details on upgrading the matrix using the USB port.

Upgrading using the Web interface



IMPORTANT: *DO NOT* power-off or disconnect the AC power cord from the matrix, at any time, during the firmware upgrade process.

1. Download the firmware update from the Support section of the Gefen Web site.
2. Extract the firmware file from the .ZIP file.
3. Power-ON the 6x2 Matrix for HDMI 4K x 2K.
4. Connect an Ethernet cable between the matrix and the computer running the Web interface.

It is unnecessary to disconnect any cables or extenders from the 6x2 Matrix for HDMI 4K x 2K during the update process.

5. Click the **Configuration** tab in the Web interface and click the **Browse...** button under the **System Configuration** section.
6. Select the firmware file and click the **Update** button.
7. The matrix will display a prompt to verify that the current firmware will be overwritten. Click the **OK** button on the dialog box to begin uploading the firmware file.
8. The matrix will begin the upgrade process. This process will take several minutes. The upgrade process may be monitored using the RS-232 interface.
9. After the matrix has been updated, the unit will automatically initiate a countdown to reboot.
10. After the matrix reboots, the firmware upgrade process will be complete.

Upgrading using the USB port



IMPORTANT: *DO NOT* power-off or disconnect the AC power cord from the matrix, at any time, during the firmware upgrade process.

1. Download the firmware update from the Support section of the Gefen Web site.
2. Power-ON the 6x2 Matrix for HDMI 4K x 2K.
3. Connect a USB cable between the computer and the 6x2 Matrix for HDMI 4K x 2K.

It is unnecessary to disconnect any audio / video cables from the 6x2 Matrix for HDMI 4K x 2K during the update process.

4. Once the computer is able to connect to the 6x2 Matrix for HDMI 4K x 2K, a removable-disk icon will be displayed under My Computer.
5. Extract the firmware file from the .ZIP file and drag the .bin file to the Removable Disk.
6. Disconnect the USB cable from the matrix.
7. The matrix will begin the software upgrade procedure. This process may take a few minutes. *Do not* disconnect power from the matrix during the upgrade procedure.
8. Once the firmware upgrade process has completed, the matrix will automatically reboot.

Specifications

Supported Formats	
Resolutions (max.)	<ul style="list-style-type: none"> • Ultra HD 4K x 2K (3840 x 2160 @ 30 Hz) • 1080p Full HD
Audio	<ul style="list-style-type: none"> • LPCM 7.1 • Dolby® TrueHD • DTS-HD Master Audio™

Electrical	
Maximum Pixel Clock	• 300 MHz
Routing Selectors	• 2 x Tact-type
FST Selector	• 1 x Tact-type, recessed push-button
Audio Selector	• 1 x Tact-type, recessed push-button
EDID Selector	• 1 x Tact-type, recessed push-button
Power Indicator	• 1 x LED, blue
FST Indicators	• 2 x LED, green
Audio Indicators	• 2 x LED, green
EDID Indicators	• 3 x LED, green
Routing Indicators	• 12 x LED, green

Connectors	
Video Input	• 6 x HDMI Type A 19-pin, female, locking
Video Output	• 2 x HDMI Type A 19-pin, female, locking
Audio Output	• 2 x TOSLINK®
USB	• 1 x Mini-B
RS-232	• 1 x DB-9, female
Ethernet	• 1 x RJ-45
IR Extender	• 1 x 3.5mm mini-stereo
Power	• 1 x Locking-type

Operational	
Power Input	• 5V DC
Power Consumption	• 20W (max.)
Operating Temperature	• +32 to +104 °F (0 to +40 °C)

(continued on next page)

Physical	
Dimensions (W x H x D)	<ul style="list-style-type: none">6.9" x 11.9" x 1.0" (175mm x 302mm x 26mm)
Unit Weight	<ul style="list-style-type: none">1.4 lbs (0.6 kg)



Stretch it. Switch it. Split it.
Gefen's got it. ®

20600 Nordhoff St., Chatsworth CA 91311
1-800-545-6900 818-772-9100 fax: 818-772-9120
www.gefen.com support@gefen.com



This product uses UL listed or CE compliant power supplies.