



### Key Benefits

- ▶ 12" LED, 800 x 600 native resolution
- ▶ 262 K colors / 450 cd/m<sup>2</sup> brightness
- ▶ VGA video input
- ▶ Video decoding capability up to 1080p ( option )
- ▶ Rugged structure ensures high mobility
- ▶ IP65 front protection ( NAP series )
- ▶ Professional-use durability & around-the-clock operation
- ▶ 2-year standard warranty ( upgradable up to 5 years )

### Applications

- Broadcasting / Advertising
- Traffic control / Command center
- Directory / Ticket kiosk
- Surveillance system
- Vehicle mount display
- Bathroom TV

UltraView 12 series LED monitor supports 800 x 600 resolution. 262K colors achieve high picture quality. Improved energy efficiency and fan-less architecture provides professional-use durability and around-the-clock operation.

It is more than just a standalone monitor. UltraView has a variety of embedded modules including HDMI Extender, Multi-Monitor OSD Controller and SDI Input. The embedded modules give you the ability of video remote management and transmission for multiple monitors over network.

As a versatile 800 x 600 monitor, 12 is meticulously designed to meet professional and environmental demands including IP54 Front protection, Multi-touch, Anti-reflective/Vandal proof glass, DC power input, Brightness dimming and Mounting kit for Panel-mount, VESA-mount, Universal-mount and Desktop stand.

With over 22 years' production experience, the structure is well-engineered and manufactured by our own CNC facilities and team of experts to ensure its ruggedness, mobility and quality, as well as being suitable for harsh environment applications. The structure can be customized if required to facilitate monitor installation. Our knowledgeable engineers are able to provide frame customization for specific dimensions, color, metal treatment, screen printing, bezel and mounting.

## Options

### Video Management & Transmission over Network

- Embedded HDMI Extender Module 1080p over network
- Embedded Multi Monitor OSD Control Module over serial
- Embedded 3G / HD / SD-SDI Input Module
- Embedded Brightness Dimming Module
- HDMI 1.2 / S-Video + BNC / DVI-D

### Bezel & Frame Customization

- Dimension
- Color & Treatment
- Screen Printing
- Stainless Steel Bezel

### Touchscreen & Glass Protection

- Projected Capacitive 10-point Touch
- 5-Wire Resistive 1-point Touch
- Capacitive 1-point Touch
- Anti-reflective Glass
- Vandal Proof Glass

### DC Power

- 12V / 24V / 48V / 125VDC ( 50 Watt )

### Mounting

- VESA mount, 75 x 75mm ( bundled )
- Universal mount ( ready for OP model )
- Desktop stand ( option )
- Panel mount ( bundled )

6mm aluminum front bezel



AP-12

6mm aluminum front bezel   
NEMA 4 / IP65 front protection



NAP-12

Aluminum front cover



DP-12

Universal open frame



OP-12

Diagrams ( mm )

Front View

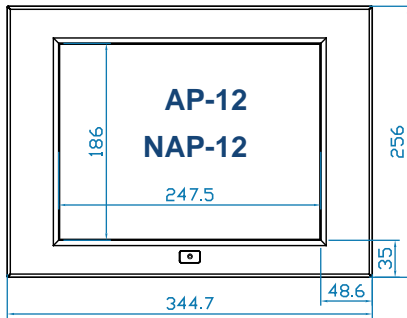

Side View

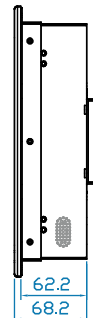

Rear View

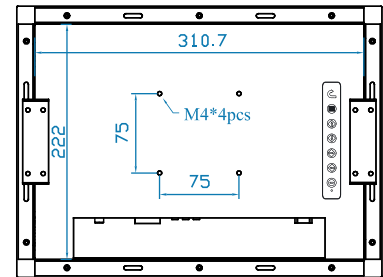

Front View

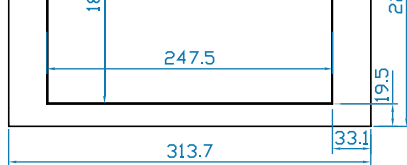

Side View

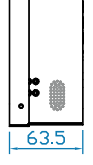

Rear View

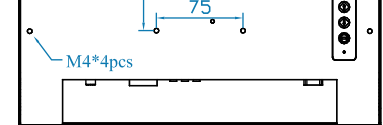

Front View

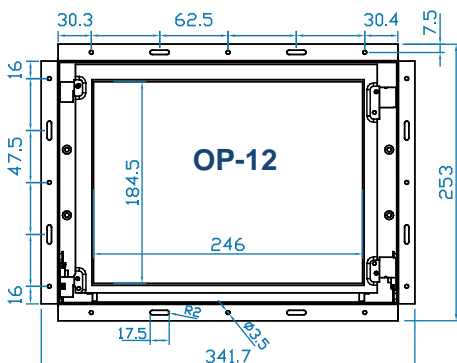

Side View

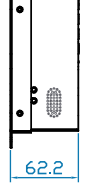

Rear View

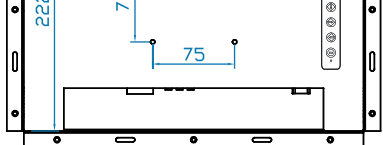

Options — Video Management & Transmission over Network

**Embedded HDMI Receiver Module 1080p**

- Extends the HDMI signal over a single Cat5/6 cable
- Supports video resolutions up to 1080p / 60Hz
- One to one just via Cat5/6 cable
- One to multi via network hub and Cat5/6 cable
- 100m maximum Cat5/6 cable distance
- Supports bi-directional IR communication
- High Speed HDMI 1.3 and HDCP 1.1 compliant
- No software or drivers required

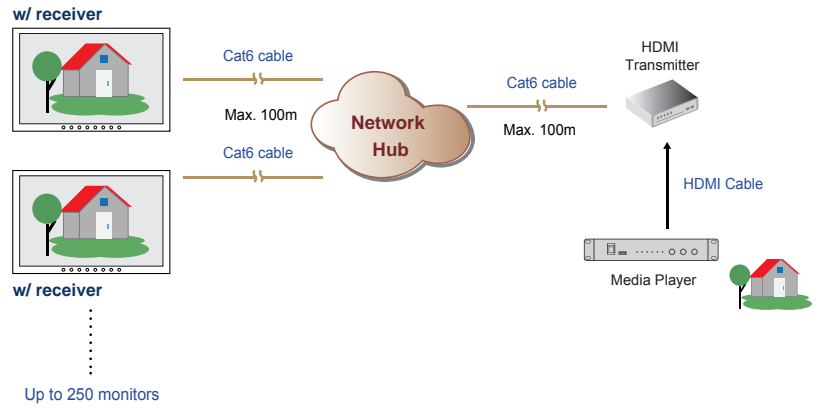

**Part no.**  
 Embedded HDMI Receiver Module : **UV-R100F**  
 Standalone HDMI Transmitter : **UV-T100F**

**Embedded Multi Monitor OSD Control Module over serial**

- Remote control the monitor OSD via RS-232C serial interface
- Daisy chain up to 64 monitors via Cat5/6 cable
- Individual ID for individual monitor OSD settings
- Power ON or OFF monitor
- Adjust brightness & audio
- Switch video sources

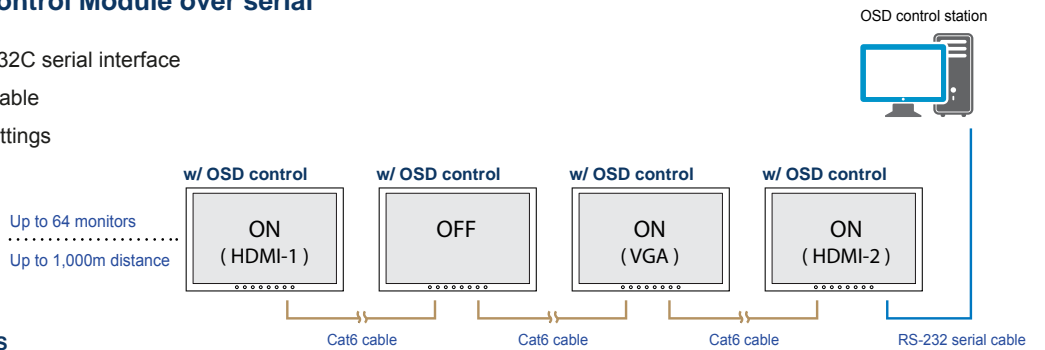

**Part no.**  
 Embedded Multi Monitor OSD Control Module : **MCS**

**Embedded 3G / HD / SD-SDI Input Module**

- Intelligent SDI monitoring with broadcast quality scopes
- Supports multi-rate 3G / HD / SD-SDI format
- Provides input to output loop-through capability
- Auto format sensing & selection

**Part no.**  
 Embedded 3G / HD / SD-SDI Input Module : **SDI**

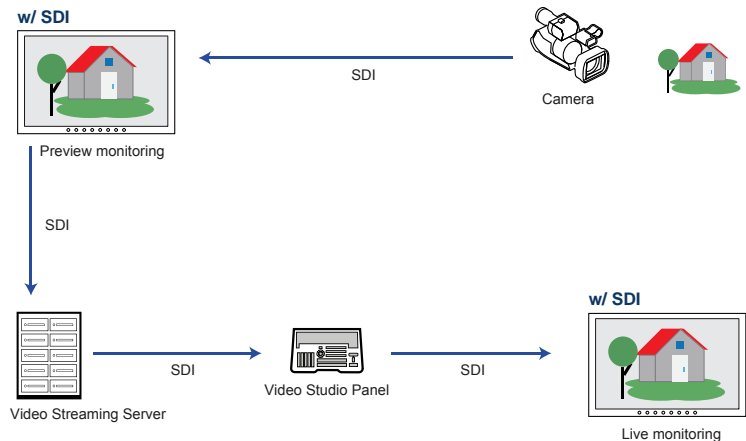

## Options — Video Management &amp; Transmission over Network

**Embedded Auto Brightness Dimming Module**

- Brightness changes according to its ambient brightness
- Its brightness change causes 10% increase or decrease

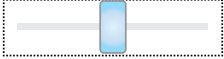
**Part no.**Embedded Brightness Auto Dimming Module : **DA-01****Embedded Manual Brightness Dimming Knob**

- Easy-to-use IP54 dimming knob on the front panel
- One click causes 2% brightness increase or decrease
- Brightness adjustment from 0% to 100%

**Part no.**Brightness Dimming Knob : **DS-01**

## Option — e-Resistive 1-point Touch

	TRB e-Resistive
Technology	5-Wire Resistive
Touch Point	Single
Input Type	Finger or Stylus
Resolution	2048 x 2048
Response Speed	15 ms
Activation Force	≤ 50 g
Surface Hardness	3H
Light Transmission	80% ± 3%
Haze	8% ± 3%
Durability	10 million touches
Top Layer	ITO Film
Bottom Layer	ITO Glass
Thickness	2.2 ± 0.2 mm
Connector	USB Type A
Compatibility	Windows 7 / XP / Linux / Mac

Part no. : 12TRB

\*\* Dimension will be changed if multi-touch required

## Option — e-Capacitive 1-point Touch

	TCB e-Capacitive
Technology	Capacitive
Touch Point	Single
Input Type	Finger
Resolution	2048 x 2048
Response Speed	20 ms
Activation Force	≤ 50 g
Surface Hardness	9H
Light Transmission	92% ± 2%
Haze	7%
Durability	300 million touches
Top / Bottom Layer	Glass
Thickness	2.8 mm ± 10%
Connector	USB Type A
Compatibility	Windows 7 / XP / Linux / Mac

Part no. : 12TCB

\*\* Dimension will be changed if multi-touch required

## Option — Projected Capacitive 10-point Touch

	TPC-10 Multi-touch
Technology	Projected Capacitive
Touch Point	10 point touch standard ( special requirement available )
Input Type	Finger or Capacitive Stylus
Resolution	2048 x 2048
Touch Point Accuracy	± 10 mm offset
Response Speed	Max. 20 ms
Activation Force	≤ 10 g
Surface Hardness	7H
Light Transmission	≥ 88%
Haze	≤ 2%
Durability	> 100 million touches
Top Layer	1.8 mm Tempered Glass
Bottom Layer	Film
Thickness	2.2 mm
Connector	USB Type A
Compatibility	Windows 7

Part no. : 12-TPC10

\*\* Dimension will be changed if multi-touch required

## Options — DC Power

		12V	24V	48V	125V
Input rating	Input voltage	12-Volt	24-Volt	48-Volt	110-Volt
	Input range	9 ~ 18V	18 ~ 36V	36 ~ 75V	66 ~ 160V
Input current	No load	50 mA	50 mA	50 mA	35 mA
	Full load	4950 mA	2450 mA	1220 mA	749 mA
Output rating	Output voltage	12-Volt	12-Volt	12-Volt	12-Volt
	Output current	4.16A	4.16A	4.16A	6.25A
Efficiency		84%	85%	85%	91%

Part no. : 12VDC  
24VDC  
48VDC  
125VDC

## Product Specifications

LCD Panel	
Panel size (diagonal)	12.1-inch widescreen TFT color LCD
Native resolution	800 x 600
Brightness (cd/m <sup>2</sup> )	450
Contrast ratio (typ.)	700 : 1
Colors	262 K
Viewing angle (L/R/U/D)	80/80/65/75
Response time (ms)	35
Dot pitch (mm)	0.3075
Display area (mm)	246H x 184.5V
Surface treatment	Anti-glare
Surface hardness	3H
Backlight type	LED
MTBF (hrs)	50,000

Video	
VGA	Analog 0.7Vp-p

Video Option	
Composite ( BNC )	NTSC & PAL
S-Video ( 4-pin )	NTSC & PAL
DVI	DVI-D single link
HDMI	HDMI 1.2 / HDCP 1.1

Audio Option	
Audio input :	
Connector	3.5mm stereo jack
Impedance / Power level	30kΩ / 750mV
Audio output :	
Connector	3.5mm stereo jack
Resistance / Power level	30kΩ / 2.8V
Speaker :	
Dual stereo speaker	2W x 2

\*When the audio output is connected, speaker output is OFF

Power	
Input	Auto-sensing 100 to 240VAC, 50 / 60Hz
Consumption :	
Screen on	Max. 14W
Power saving mode	Max. 4W
Power button off	Max. 1W

Environment	
Operating temp.	0 to 55°C degree
Storage temp.	-20 to 60°C degree
Operating humidity	20~90%, non-condensing
Storage humidity	5 ~90%, non-condensing
Operating altitude	16,000 ft
Non-operating altitude	40,000 ft
Shock	10G acceleration ( 11ms duration )
Vibration	10~300Hz 0.5G RMS random vibration

Design	AP-12	NAP-12	DP-12	OP-12
Protection	6mm front bezel	NEMA 4 / IP65	front cover	open frame
Front panel	Black, RAL 9005			-
Rear casing	Black, RAL 9005			

Mounting	AP-12 / NAP-12	DP-12	OP-12
VESA mount	75 x 75 mm	75 x 75 mm	75 x 75 mm
Universal mount	-	-	ready
Desktop stand	option	option	-
Panel mount	bundled	-	-

Physical	AP-12 / NAP-12		DP-12	OP-12
Product (W x D x H) :				
mm	344.7 x 68.2 x 256		313.7 x 63.5 x 255	341.7 x 62.2 x 253
inch	13.6 x 2.7 x 10.1		12.4 x 2.5 x 10	13.5 x 2.5 x 10
Packing (W x D x H) :				
mm	515 x 117 x 429		515 x 117 x 429	515 x 117 x 429
inch	20.3 x 4.6 x 16.9		20.3 x 4.6 x 16.9	20.3 x 4.6 x 16.9
Net weight	3.5 kg / 7.7 lb	3.5 kg / 7.7 lb	3 kg / 6.6 lb	2.5 kg / 5.5 lb
Gross weight	5.5 kg / 12.1 lb	5.5 kg / 12.1 lb	5 kg / 11 lb	4.4 kg / 9.7 lb
Chassis color	Dark			
Chassis materials	Aluminum			

Compliance	
EMC	FCC & CE certified
Safety	CE / LVD certified
Environment	RoHS2 & REACH compliant

Applicable Format		
DVI-D / VGA Input	PC signal	800 x 600 x 60 / 72 / 75Hz 720 x 400 x 70Hz 640 x 480 x 60 / 72 / 75Hz 640 x 400 x 70Hz 640 x 350 x 70Hz
	Audio signal	2ch Linear PCM
HDMI input	PC signal	Same as VGA
	HDMI 1.2	720 x 480 x 50 / 60Hz ( 576p / 480p )
	Audio signal	2ch Linear PCM

## UltraView Family

UltraView series covers a full range of professional LCD display sizes from 6.5" to 55". Please select from the below the most suitable model for your application.

### Sales Inquiry

[inquiry@austin-hughes.com](mailto:inquiry@austin-hughes.com)

### Technical Support

[support@austin-hughes.com](mailto:support@austin-hughes.com)

#### 16 : 9 ( 4K / 1080p )

- K55"
- K43"
- K32"
- K28"
- K23"
- K17"
- K15"

#### 16 : 9 ( 1080p )

- F21"
- F17"
- F15"

#### 16 : 10

- X24" ( 1920 x 1200 )
- X17" ( 1920 x 1200 )
- W19" ( 1440 x 900 )

#### 4 : 3

- 20" ( 1600 x 1200 )
- 19" ( 1280 x 1024 )
- 17" ( 1280 x 1024 )
- 15" ( 1024 x 768 )
- 12" ( 800 x 600 )
- 10" ( 800 x 600 )
- 8" ( 800 x 600 )
- 6" ( 640 x 480 )

## Sunlight Readable

#### 16 : 9 ( 4K / 1080p )

- K55"
- K43"
- K32"

#### 16 : 9 ( 1080p )

- F21"
- F17"
- F15"

#### 16 : 10

- W19" ( 1440 x 900 )

#### 4 : 3

- 19" ( 1280 x 1024 )
- 17" ( 1280 x 1024 )

**Austin Hughes** has an extensive distribution network, including EMEA, the Americas & APAC.

Contact your nearest sales office for details of local presentation.

### Sales Inquiry

[inquiry@austin-hughes.com](mailto:inquiry@austin-hughes.com)

### Technical Support

[support@austin-hughes.com](mailto:support@austin-hughes.com)

Distributed by:

Distributor by country on application