



Simply Better Connections

VE8900 / VE8950 / VE8952

HDMI over IP Video Extender Series
User Manual

Compliance Statements

FEDERAL COMMUNICATIONS COMMISSION INTERFERENCE STATEMENT

This equipment has been tested and found to comply with the limits for a Class A digital device, pursuant to Part 15 of the FCC Rules. These limits are designed to provide reasonable protection against harmful interference when the equipment is operated in a commercial environment. This equipment generates, uses, and can radiate radio frequency energy and, if not installed and used in accordance with the instruction manual, may cause harmful interference to radio communications. Operation of this equipment in a residential area is likely to cause harmful interference in which case the user will be required to correct the interference at his own expense.

The device complies with Part 15 of the FCC Rules. Operation is subject to the following two conditions: (1) this device may not cause harmful interference, and (2) this device must accept any interference received, including interference that may cause undesired operation.

FCC Caution

Any changes or modifications not expressly approved by the party responsible for compliance could void the user's authority to operate this equipment.

Warning

Operation of this equipment in a residential environment could cause radio interference.

Achtung

Der Gebrauch dieses Geräts in Wohnumgebung kann Funkstörungen verursachen.

Suggestion

Shield twisted pair (STP) cables must be used with the unit to ensure compliance with FCC & CE standards.



KCC Statement

유선 제품용 / A 급 기기 (업무용 방송 통신 기기)
이 기기는 업무용 (A 급) 전자파적합기기로서 판매자 또는 사용자는 이
점을 주의하시기 바라며, 가정 외의 지역에서 사용하는 것을 목적으로
합니다.

HDMI Trademark Statement

The terms HDMI, HDMI High-Definition Multimedia Interface, and the HDMI Logo are trademarks or registered trademarks of HDMI Licensing Administrator, Inc.



RoHS

This product is RoHS compliant.

User Information

Online Registration

Be sure to register your product at our online support center:

International	http://eservice.aten.com
---------------	---

Telephone Support

For telephone support, call this number:

International	886-2-8692-6959
China	86-400-810-0-810
Japan	81-3-5615-5811
Korea	82-2-467-6789
North America	1-888-999-ATEN ext 4988 1-949-428-1111

User Notice

All information, documentation, and specifications contained in this manual are subject to change without prior notification by the manufacturer. The manufacturer makes no representations or warranties, either expressed or implied, with respect to the contents hereof and specifically disclaims any warranties as to merchantability or fitness for any particular purpose. Any of the manufacturer's software described in this manual is sold or licensed *as is*. Should the programs prove defective following their purchase, the buyer (and not the manufacturer, its distributor, or its dealer), assumes the entire cost of all necessary servicing, repair and any incidental or consequential damages resulting from any defect in the software.

The manufacturer of this system is not responsible for any radio and/or TV interference caused by unauthorized modifications to this device. It is the responsibility of the user to correct such interference.

The manufacturer is not responsible for any damage incurred in the operation of this system if the correct operational voltage setting was not selected prior to operation. PLEASE VERIFY THAT THE VOLTAGE SETTING IS CORRECT BEFORE USE.

Product Information

For information about all ATEN products and how they can help you connect without limits, visit ATEN on the Web or contact an ATEN Authorized Reseller. Visit ATEN on the Web for a list of locations and telephone numbers:

International	http://www.aten.com
North America	http://www.aten-usa.com

Package Contents

Check to make sure that all of the components are in working order. If you encounter any problem, please contact your dealer.

VE8900T

- 1 VE8900 HDMI over IP Transmitter
- 1 RS-232 terminal block
- 1 5V power adapter
- 4 foot pads
- 1 user instructions

VE8900R

- 1 VE8900 HDMI over IP Receiver
- 1 RS-232 terminal block
- 1 5V power adapter
- 4 foot pads
- 1 user instructions

VE8950T

- 1 VE8950 4K HDMI over IP Transmitter
- 1 RS-232 terminal block
- 1 5V power adapter
- 4 foot pads
- 1 user instructions

VE8950R

- 1 VE8950 4K HDMI over IP Receiver
- 1 RS-232 terminal block
- 1 5V power adapter
- 4 foot pads
- 1 user instructions

VE8952R

- 1 VE8952 4K HDMI over IP Receiver with PoE
- 1 RS-232 terminal block
- 1 5V power adapter
- 4 foot pads
- 1 user instructions

VE8952T

- 1 VE8952 4K HDMI over IP Transmitter with PoE
- 1 RS-232 terminal block
- 1 5V power adapter
- 4 foot pads
- 1 user instructions

Contents

Compliance Statements	ii
User Information	iv
Product Information	v
Package Contents	vi
Contents	viii
About This Manual	xi
Conventions	xii

1. Introduction and Getting Started

Overview	1
Features and Benefits	2
Getting Started Tasks	7

2. Hardware Setup

Components	9
VE8900T / VE8950T / VE8952T Rear View	10
VE8900R / VE8950R / VE8952R Front View	10
VE8900T / VE8950T / VE8952T Top View	12
VE8900R / VE8950R / VE8952R Top View	13
Mounting the VE8900 / VE8950 / VE8952 Device	14
Wall Mount	14
Rack Mount	14
Connecting VE8900 / VE8950	15
Connecting VE8952	18

3. Panel Operation

Overview	21
Status LEDs	21
Panel Controls	22
Assigning Sources Using the Device Panel	24

4. Management

Overview	25
Looking Up the Login IP Address	26
Looking Up the Login IP Address from OSD	26
Find My VE Extension	27
Start VE Manager using Find My VE Extension	29
Logging In and Configuring VE Manager	31
The Main Screen	34
Apply / Auto Apply	35
Assigning Sources Using VE Manager	36
Configuring and Setting Up a Video Wall	39

Creating a Video Wall Layout	40
Editing a Video Wall Layout	42
Editing a Preview	43
Profile	44
Creating a Profile	44
Edit, Delete and Disconnect Profile	46
Edit	46
Delete	47
Disconnect	47
Select / Apply Profile	48
Setup Profile Schedules	49
Managing VE8900 / VE8950 / VE8952 Devices	52
Checking VE8900 / VE8950 / VE8952 Statuses	52
5. System Settings	
Overview	53
General Settings	53
Transmitter Settings	55
Receiver Settings	57
Batch Configuration	59
Maintenance	61
Upgrading VE8900 / VE8950 / VE8952 Device Firmware	61
Synchronizing All Devices	62
Backing Up VE8900 / VE8950 / VE8952 Device Settings	62
Restoring VE8900 / VE8950 / VE8952 Device Settings	63
Recovery Mode	63
Account Settings	64
6. CLI Commands	
Overview	65
Before You Start	65
Executing Commands	66
Commands	68
Guidelines	68
Switching Sources	69
Examples	69
Switching Video, USB, RS-232, and/or IR Paths	70
Examples	70
Disabling Video, USB, RS-232, and/or IR Paths	71
Example	71
Displaying Port-Switching Alerts	72
Looking Up System Settings	73
Configuring Video Wall Settings	74
Example	75
Muting VE8900 / VE8950 / VE8952 Receivers or Video Walls	76
Examples	76

Disabling a Video Output	77
Enabling / Disabling the OSD Display of a Receiver	78
Configuring the EDID Mode	79
Rebooting the VE8900 / VE8950 / VE8952	80
Examples	80
Setting the Baud Rate	81
Examples	81
Displaying Device Status	82
Examples	82
Setting the Audio Source of a Transmitter	83
Examples	83
Restoring Factory Default Value	84
Examples	84
Enabling / Disabling the HDCP of a Transmitter	85
Examples	85
Setting the Fast Switch Output Resolution of a Receiver	86
Examples	86
Applying Profile via the Profile Name or ID	87
Example	87
Enabling / Disabling the HDMI Blackscreen	87
Examples	87

7. Mobile Control App

Overview	89
Requirements	89
Main Page	90
Live Views	91
Switching a Source	91
Switching Multiple Sources and Displays	93
Changing the Operation Mode of a Video Wall/Display	96
Applying a Display Profile	97
Configuring the Profile Schedule	98
System Settings and Status	100

Appendix

Safety Instructions	101
General	101
Rack Mounting	103
Technical Support	104
Specifications	105
Supported Browsers	109
Limited Warranty	110

About This Manual

This User Manual is provided to help you get the most from your VE8900 / VE8950 / VE8952 device and the ATEN VE Manager. It covers all aspects of installation, configuration, and operation. An overview of the information found in the manual is provided below.

Chapter 1, Introduction and Getting Started, introduces you to the features and purposes of VE8900 / VE8950 / VE8952 HDMI over IP Video Extenders.

Chapter 2, Hardware Setup, introduces you to panel components and provides step-by-step instructions for installing and setting up your VE8900 / VE8950 / VE8952 hardware.

Chapter 3, Panel Operation, provides LED indicator information and functions of the panel pushbuttons.

Chapter 4, Management, provides an overview of the VE Manager's main screen and step-by-step instructions of creating and editing display layouts.

Chapter 5, System Settings, provides information on the general settings, and how to back up, restore, and upgrade the VE8900 / VE8950 / VE8952 system firmware.

Chapter 6, CLI Commands, provides information on required configurations for establishing sessions via telnet, TCP, or RS-232 serial signals, and list of supported CLI commands.

Chapter 7, Mobile Control App, provides information on installing, configuring, and using the application.

Appendix, provides product safety instructions, technical support details, and product specifications.

Note:

- ◆ Read this manual thoroughly and follow the installation and operation procedures carefully to prevent any damage to the unit or any connected devices.
- ◆ The product may be updated, with features and functions added, improved or removed since the release of this manual. For an up-to-date user manual, visit <http://www.aten.com/global/en>

Conventions

This manual uses the following conventions:

- | | |
|---|--|
| Monospaced | Indicates text that you should key in. |
| [] | Indicates keys you should press. For example, [Enter] means to press the Enter key. If keys need to be chorded, they appear together in the same bracket with a plus sign between them: [Ctrl+Alt]. |
| 1. | Numbered lists represent procedures with sequential steps. |
| ◆ | Bullet lists provide information, but do not involve sequential steps. |
| > | Indicates selecting the option (on a menu or dialog box, for example), that comes next. For example, Start > Run means to open the <i>Start</i> menu, and then select <i>Run</i> . |
|  | Indicates critical information. |

Chapter 1

Introduction and Getting Started

Overview

The ATEN VE8900 / VE8950 / VE8952 Video over IP Extenders deliver visually lossless 1080p (VE8900) / 4K AV (VE8950 / VE8952) signals with low latency over long distance via a standard Gigabit Ethernet switch.

ATEN's Video over IP solution is designed to address the challenges that system integrators encounter when implementing AV over IP solutions and provides an effective, easy-to-use, and economical digital signage solution with the following features and advantages:

- ◆ Limitless scalability and flexibility
- ◆ No complicated IP setup
- ◆ No additional server PCs or software required
- ◆ Go further for less with daisy chaining
- ◆ Flexible control with Mobile App
- ◆ Convenient integration and installation

Engineered to meet today's demands of large scale, multi-display, 1080p (VE8900) /4K (VE8950 / VE8952) signal transmission, and designed to be easy to set up and operate, the VE8900 / VE8950 / VE8952 Video over IP Extender is an ideal product for a wide range of environments, such as trade shows, airports, university campuses, conference centers, and shopping centers.

Features and Benefits

Light weight Compression with Ultra-low Latency

- ◆ Delivers visually lossless high-quality video up to 1080p @ 60 Hz (VE8900) / 4K @ 30 Hz 4:4:4 (VE8950 / VE8952)
- ◆ Ensures stunning quality video using ATEN advanced video lossless compression technology
- ◆ EDID Expert™ selects the optimum EDID settings for smooth power-up, high-quality display and the best video resolution across different screens
- ◆ Offers different levels of video compression rate including Smooth, Balance, and High Quality for users to choose depending on practical usage

Power over Ethernet Support

- ◆ Locate VE8952 anywhere without having to install additional power cabling and outlets

Note: Only VE8952 supports PoE function, and VE8900 / VE8950 does not.

Limitless Scalability and Flexibility

- ◆ Extends AV connections from a simple point-to-point to a multi-point to multi-point setup via LAN without distance limitations
- ◆ Offers multi-functionality in extender, splitter, matrix switch, video wall and daisy chain applications
- ◆ Mix and match the latest 4K displays (VE8950 / VE8952) and 1080p screens (VE8900). The built-in scaler automatically scales up incoming video signal to match the maximum resolution of the connected display devices

Collaboration with ATEN Control System

- ◆ Integrated solution – Compatible with ATEN Control System, allowing users to directly operate VE8900 / VE8950 / VE8952 via CLI Telnet, RS-232 protocol, or Mobile Control App
- ◆ Effortless operation – One click to effectively operate VE Manager, TV, projector, source player, and related equipments via touch panel and keypad

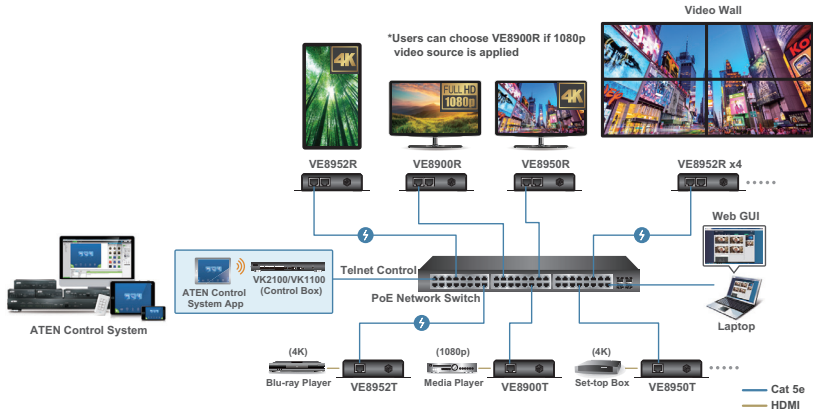

Note:

- ◆ Only VE8952 supports PoE and can be installed in combination with PoE Ethernet switches to reduce power cabling and additional power outlets.
- ◆ For more information about choosing the Ethernet switch or bandwidth requirements; refer to the *ATEN HDMI over IP Video Extender System Implementation Guide*.

Spontaneous Scheduling Management

- ◆ Offers an user-friendly scheduling management function for users to pre-plan the display schedule
- ◆ Provides robust and intuitive scheduling management options to help users to manage all events in the calendar to as detailed as to setting events to minute intervals
- ◆ Integrates all VE89 units to arrange the profile by grouping individual receiver or video wall
- ◆ Multiple profiles can be arranged to play in any order over a selected period of time

No Complicated IP Setup

- ◆ Simple configuration that requires no extensive IT experience or extra learning
- ◆ Effortlessly switches among input sources via top panel pushbuttons

Web GUI-Based Management, No Additional Server PCs or Software Required

- ◆ Simple Access – Without typing IP address on Chrome browser, users are allowed to directly link to VE Manager via one click on “Find My VE” Chrome based free tool

Go Further For Less with Daisy Chaining

- ◆ Connects multiple displays through a single port to utilize every port of the Ethernet switch and maximize their value
- ◆ Easily expandable – cabling and system deployment is easy with no huge Ethernet switches and fewer cables needed
- ◆ Perfect for large-scale deployment covering hundreds of meters, such as hotel facilities, airports, university campuses, stations, shopping malls, and exhibition centers

Note:

- ◆ Depending on your network architecture, we recommend daisy chaining up to 30 units. Please contact ATEN representatives for more details.
- ◆ For Daisy Chain installation setup for VE8952 units, only the first level of VE8952 supports PoE powering function. All the other VE8952 units installed on the second level or above will need power adapter and PoE does not work.

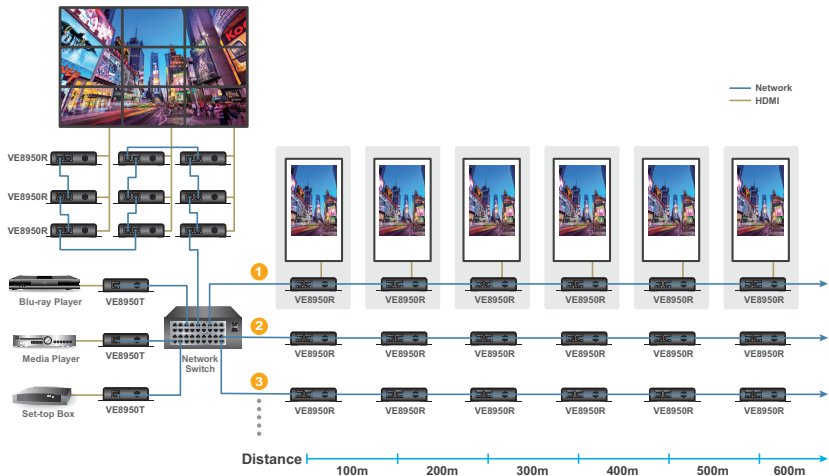

- Note: 1. VE8952 PoE function does not support power delivery under daisy chain installation.
 2. Use daisy chains to configure a video wall or expand the AV system hundreds of meters

Video Wall Support

- ◆ Supports up to 8 x 8 video wall (64 displays)
- ◆ Supports horizontal or vertical (90° and 270° rotation) display orientation
- ◆ Easily switches layout profiles, preview and drag-and-drop video sources via the intuitive web GUI

Note: If you experience issues related to your network architecture, please contact ATEN representatives for support.

Embedded / De-embedded Audio Support

- ◆ For VE8900T / VE8950T / VE8952T – separate audio signal can be embedded into the HDMI stream
- ◆ For VE8900R / VE8950R / VE8952R – audio stream can be extracted from the HDMI stream and delivered as a separate audio signal

Multiple Control Channels

- ◆ Multiple control methods – the system can be managed via Ethernet or top-panel pushbuttons
- ◆ USB Connectivity – USB port (USB 2.0) allows for connection of devices such as keyboard, mouse, flash drive, printer, and other USB peripherals*
- ◆ Bi-directional IR Channel – IR transmission is processed one way at a time
- ◆ RS-232 Channel – bi-directional RS-232 serial port allows for connection of peripherals such as touch screens and bar code scanners

Note: Each VE8900 / VE8950 / VE8952 transmitter can be controlled by a total of 4 USB touch screens installed to VE8900 / VE8950 / VE8952 receivers.

Getting Started Tasks

Follow the steps below to install, connect, configure, and get started with your VE8900 / VE8950 / VE8952 devices.

1. Decide your network architecture and configuration. For more information, see the *ATEN HDMI over IP Video Extender System Implementation Guide*.
2. Mount your VE8900 / VE8950 / VE8952 devices on walls or racks. For more information, see *Mounting the VE8900 / VE8950 / VE8952 Device*, page 14.
3. Connect the VE8900 / VE8950 / VE8952 devices to sources, displays, network, and other hardware devices as required. For more information, see the installation diagrams on *Connecting VE8900 / VE8950*, page 15, and *Connecting VE8952*, page 18.
4. Use one of the following methods to assign input sources.

Note: Skip this step if you have a point-to-point setup. In a point-to-point setup, source input is automatically assigned.

- ◆ Assign input sources using the device panel.
For more information, see *Assigning Sources Using the Device Panel*, page 24.
- ◆ Assign input sources using VE Manager.
For more information, see *Logging In and Configuring VE Manager*, page 31 and *Find My VE Extension*, page 27.

This Page Intentionally Left Blank

Chapter 2

Hardware Setup



Before you proceed to hardware setup:

1. Please review the safety information regarding the placement of this device in *Safety Instructions*, page 101.
2. Do not power on the VE8900 / VE8950 / VE8952 device until all the necessary hardware is connected.

Components

VE8900T / VE8950T / VE8952T Front View

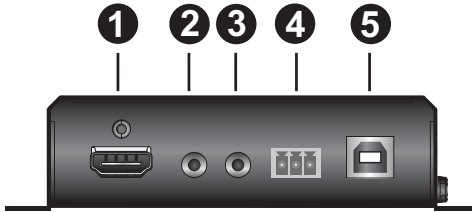

No.	Component	Function
1	HDMI input port	Connects an HDMI cable from the source device.
2	audio input port	Connects to an analog audio player from the source device. Note that microphones are not supported.
3	bi-directional IR port	Connects to an IR receiver / transmitter to allow for configuration using a remote control.
4	RS-232 serial port	Connects to a computer for serial control.
5	USB Type-B port	Connects to a source (e.g. PC / Mac).

VE8900T / VE8950T / VE8952T Rear View

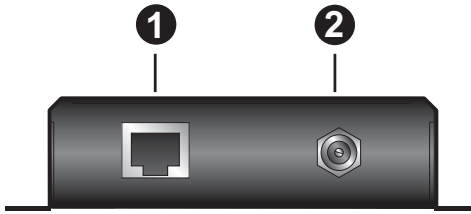

No.	Component	Function
1	LAN port with PoE	Connects the unit to LAN with a network cable. Note: Only VE8952 supports PoE function, and VE8900 / VE8950 does not.
2	power jack	Connects to the DC power adapter to provide power to the unit.

VE8900R / VE8950R / VE8952R Front View

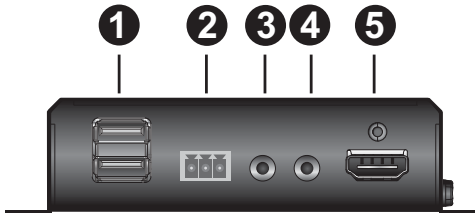

No.	Component	Function
1	USB Type-A ports	Connects to virtual media or a USB peripheral device.
2	RS-232 serial port	Connects to a serial device.
3	bi-directional IR port	Connects to an IR receiver / transmitter to allow for configuration using a remote control.
4	audio output port	Connects to a speaker from the output device.
5	HDMI output port	Connects to an HDMI cable from the output device.

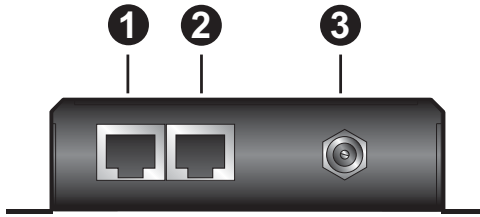
VE8900R / VE8950R / VE8952R Rear View

No.	Component	Function
1	LAN 1 port with PoE	Connects the unit to LAN with a network cable. Note: Only VE8952 supports PoE function, and VE8900 / VE8950 does not.
2	LAN 2 port	Connects to another VE8900R / VE8950R with a network cable in a daisy-chain setup.
3	power jack	Connects to the DC power adapter to provide power to the unit.

VE8900T / VE8950T / VE8952T Top View

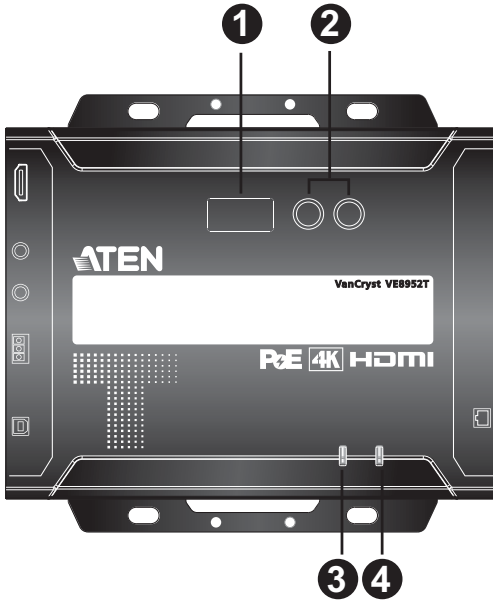

No.	Component	Function
1	ID display panel	An ID display that identifies its ID number.
2	prev (+) / next (-) buttons	<ul style="list-style-type: none"> ◆ Assign ID numbers on VE8900 / VE8950 devices. ◆ Assign the source video (transmitter) for the receiver.
3	link LED	Lights orange to indicate the LAN port 1 is connected to an Ethernet switch. For information, see <i>Status LEDs</i> , page 21.
4	power LED	Lights green to indicate the unit is receiving power. For information, see <i>Status LEDs</i> , page 21.

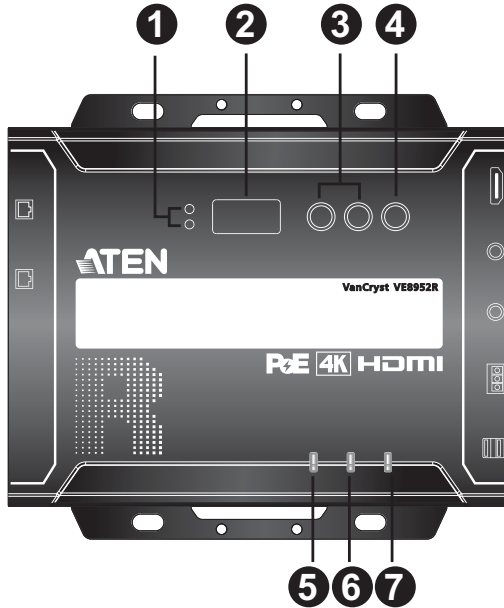
VE8900R / VE8950R / VE8952R Top View

No.	Component	Function
1	Tx / Rx LEDs	Lights to indicate whether the displayed ID number is of Tx or Rx.
2	ID display panel	An ID display that identifies its ID number or the transmitter's ID number when the panel control is switched to Tx.
3	prev (+) / next (-) buttons	<ul style="list-style-type: none"> ◆ Assign ID numbers on VE8900 / VE8950 devices. ◆ Assign the source video (transmitter) for the receiver.
4	Tx / Rx switch button	Press to switch control between a receiver and its corresponding transmitter.
5	HDMI out LED	Lights orange to indicate the video output is stable. For information, see <i>Status LEDs</i> , page 21.
6	link LED	Lights orange to indicate the LAN port 1 is connected to an Ethernet switch. For information, see <i>Status LEDs</i> , page 21.
7	power jack	Connects to the DC power adapter to provide power to the unit. For information, see <i>Status LEDs</i> , page 21.

Mounting the VE8900 / VE8950 / VE8952 Device

Wall Mount

Secure or hang the VE8900 / VE8950 / VE8952 device to the wall using the built-in brackets.

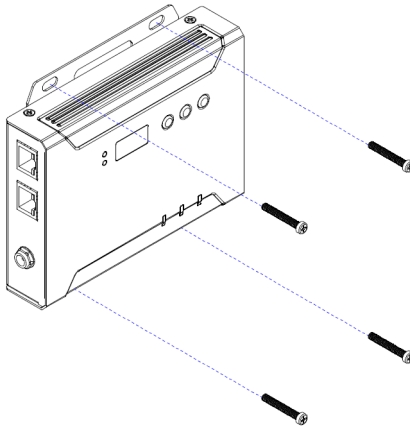

Rack Mount

Use the VE-RMK1U Rack Mount Kit to rack-mount the VE8900 / VE8950 / VE8952. For more information about this accessory, go to www.aten.com/products

Connecting VE8900 / VE8950

Follow the steps below to connect your VE8900 / VE8950 devices with the hardware as required.

Note:

- ◆ For details on LED indicators to help you identify statuses of connection or signal transmission, see *Status LEDs*, page 21.
- ◆ For a list of compatible ATEN products, visit the VE8900 / VE8950 product web page at www.aten.com

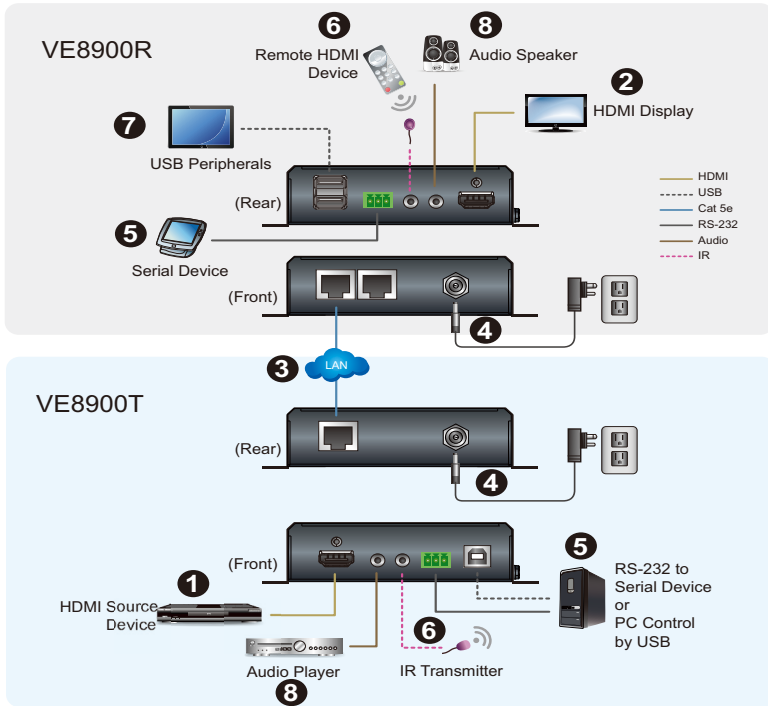

1. Connect the HDMI In port on the VE8900T / VE8950T device to the HDMI output port on your video source device using an HDMI cable.
2. Connect the HDMI Out port on the VE8900R / VE8950R device to the HDMI input port on your display device using an HDMI cable.
3. Depending on your deployment type, connect your VE8900T / VE8950T and VE8900R / VE8950R to the same LAN.
 - ◆ Point-to-point deployment: directly connect the LAN 1 ports of your VE8900T / VE8950T and VE8900R / VE8950R with an RJ-45 cable.
 - ◆ Splitter and matrix deployment: connect the LAN 1 ports of your VE8900T / VE8950T and VE8900R / VE8950R to the same Ethernet switch with RJ-45 cables.
4. Plug the power adapter into the power jack on the VE8900T / VE8950T and VE8900R / VE8950R devices.
5. (Optional) Connect an RS-232 serial device or peripheral to the RS-232 serial port on your VE8900R / VE8950R device. This device can be a computer, a touchscreen, a barcode scanner, or a control system.^[1]
6. (Optional) Connect an IR transmitter / receiver cable to the IR bi-directional ports of your VE8900T / VE8950T and VE8900R / VE8950R devices.¹
7. (Optional) Connect USB peripherals to the USB Type-A ports on your VE8900T / VE8950T and VE8900R / VE8950R devices.^{1& 2}
8. (Optional) Connect an audio device to the VE8900R / VE8950R audio jack.³

Note:

1. The IR, RS-232, and USB signal transmissions are disabled by default. To enable the functions, go to **System Settings > Receiver > IR/RS232** or **USB** in VE Manager and select the signal source.
2. Each VE8900 / VE8950 transmitter can be controlled by a total of 4 USB touch screens installed to VE8900 / VE8950 receivers.
3. To receive HDMI audio on the VE8900 / VE8950 transmitter, make sure to configure the following in VE Manager:
 - ◆ Set the transmitter to receive HDMI audio:
Go to **System Settings > Transmitter > Audio In** in VE Manager and change the setting to **HDMI**.
 - ◆ To allow for 5.1 or 7.1 surround sound on a VE8900 / VE8950 receiver, do the following:
 - a) In VE Manager, go to **System Settings > Transmitter**, access the configuration window for the corresponding transmitter, and then set EDID to **Manual**.
 - b) From the VE Manager's preview area, click on the ... icon and select EDID to allow transmission of the receiver's EDID to the transmitter.

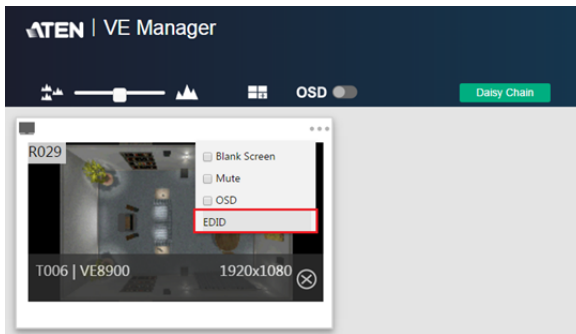

Connecting VE8952

Follow the steps below to connect your VE8952 devices with the hardware as required.

Note:

- For details on LED indicators to help you identify statuses of connection or signal transmission, see *Status LEDs*, page 21.
- For a list of compatible ATEN products, visit the VE8952 product web page at www.aten.com

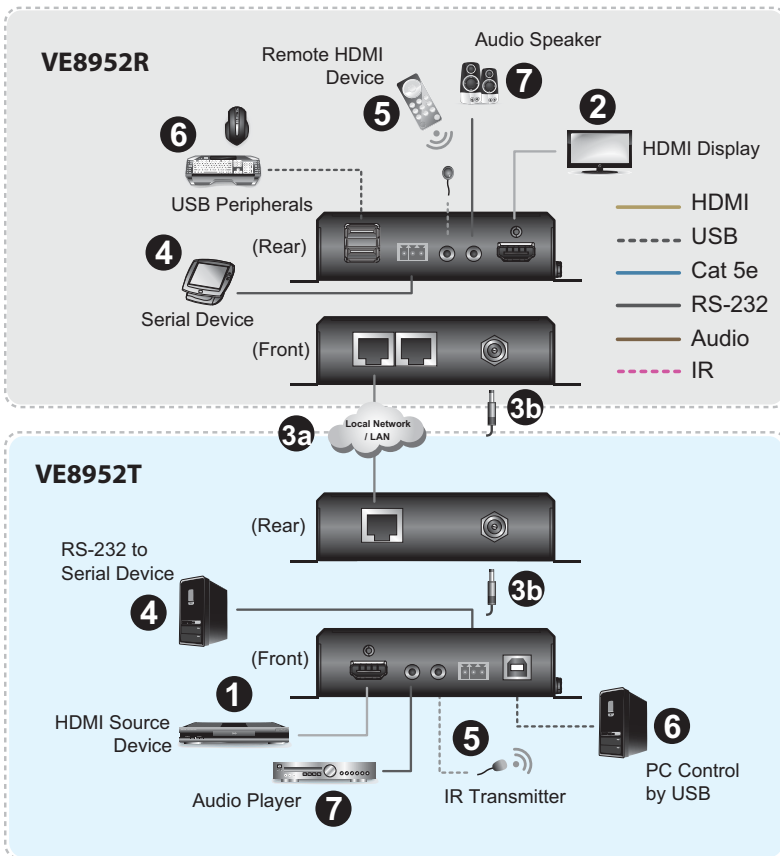

1. Connect a video source device to the HDMI input port on the VE8952T using an HDMI cable.
2. Connect a video display device to the HDMI output port on the VE8952R using an HDMI cable.
3. Set up the VE8952 units as follows. The diagram above illustrates a point-to-point setup.

Point-to-point setup

- a) Connect one end of an Ethernet cable to the LAN port on the VE8952T and the other end of the cable to the VE8952R's LAN port.
- b) Plug the power adapters into the power jacks on the VE8952T and VE8952R.

Multipoint-to-multipoint setup

- a) Install the VE8952T and VE8952R to the same local area network by connecting the LAN ports to an Ethernet switch using Ethernet cables.
- b) The VE8952 can be powered on through an Ethernet cable if the unit is connected to a PoE-supported Ethernet switch. Alternatively plug the power adapters into the power jacks on the VE8952T and VE8952R.

Note: When power supply is available from the power adapter and Ethernet cable (PoE), the power supply from the power adapter will be prioritized.

4. (Optional) To bypass RS-232 signals, connect your computer or control system to the RS-232 serial ports on the VE8952.
5. (Optional) To bypass IR signals, plug the IR receiver to the bi-directional IR port on the VE8952T/VE8952R, depending on where you wish to operate the remote controller and the IR transmitter to the VE8952T / VE8952R.
6. (Optional) To use keyboard and mouse, connect your USB peripherals such as keyboard and mouse to the VE8952R's USB Type-A ports and your PC to the VE8952T's USB Type-B port.
7. (Optional) Connect your audio devices to the audio input port on the VE8952T and audio output port on the VE8952R.

Note:

1. The IR, RS-232, and USB signal transmissions are disabled by default. To enable the functions, go to **System Settings > Receiver > IR/RS232** or **USB** in VE Manager and select the signal source.
2. Each VE8952 transmitter can be controlled by a total of 4 USB touch screens installed to VE8952 receivers.
3. To receive HDMI audio on the VE8952 transmitter, make sure to configure the following in VE Manager:
 - ◆ Set the transmitter to receive HDMI audio:
Go to **System Settings > Transmitter > Audio In** in VE Manager and change the setting to **HDMI**.
 - ◆ To allow for 5.1 or 7.1 surround sound on a VE8952 receiver, do the following:
 - a) In VE Manager, go to **System Settings > Transmitter**, access the configuration window for the corresponding transmitter, and then set EDID to **Manual**.
 - b) From the VE Manager's preview area, click on the ... icon and select EDID to allow transmission of the receiver's EDID to the transmitter.

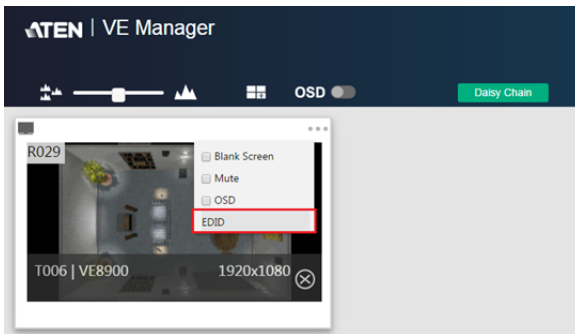

Chapter 3

Panel Operation

Overview

This chapter provides information on panel LEDs and instructions to operate the VE8900 / VE8950 / VE8952 using the panel buttons.

Status LEDs

Both the VE8900 / VE8950 / VE8952 transmitter and receiver have front panel LEDs to indicate their operating and power status.

LED	Indication	Description
power	Lights green	The device is powered on.
	Off	Power is off.
link	Lights orange	LAN is connected.
	Off	LAN is not connected.
HDMI out	Lights orange	The video output is stable.
	Blinks orange	The video output is unstable.
	Off	The video output is not transmitted.
RJ-45 connector (Left LED)	Lights orange	Data is being transmitted at 100Mbps.
	Lights green	Data is being transmitted at 1Gbps.
RJ-45 connector (Right LED)	Lights green	LAN is connected and no data is being transmitted.
	Blinks green	LAN is connected and data is being transmitted.

Note: The HDMI out LED is only available on VE8900 / VE8950 / VE8952 receivers.

Panel Controls

VE8900 / VE8950

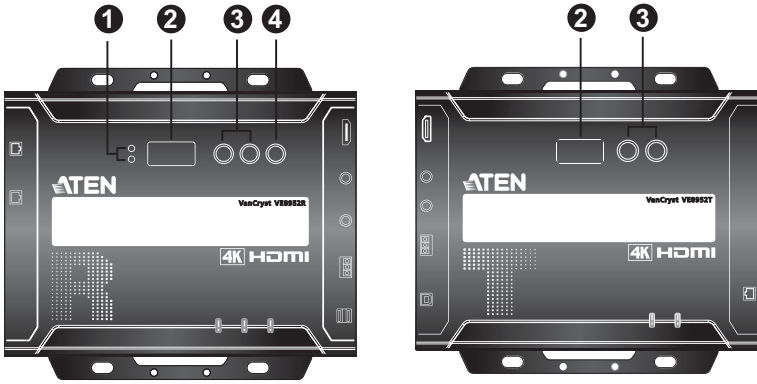

VE8900/VE8950 Receiver

VE8900/VE8950 Transmitter

Note: The unit used in the diagram above is VE8900 / VE8950, the panel control for VE8952 is identical.

No.	Name	Description
1.	Tx / Rx LEDs	Lights to indicate whether the displayed ID number is of Tx or Rx.

No.	Name	Description
2.	ID number	<ul style="list-style-type: none"> ◆ Transmitter side: Identifies its ID number. ◆ Receiver side: <ul style="list-style-type: none"> ◆ Identifies its ID number or the transmitter's ID number when the panel control is switched to Tx. ◆ If the ID number exceeds 3 digits, letter A, b, c, d, E, and F are used to replace the first two digits. A= 10, A00 ~ A99 to display ID number 1000 ~ 1099. b= 11, b00 ~ b99 to display ID number 1100 ~ 1199. c= 12, c00 ~ c99 to display ID number 1200 ~ 1299. d= 13, d00 ~ d99 to display ID number 1300 ~ 1399. E= 14, E00 ~ E99 to display ID number 1400 ~ 1499. F= 15, F00 ~ F99 to display ID number 1500 ~ 1599. <p>An ID Number blinks to indicate that it is been used by another VE8900 / VE8950 / VE8952 device.</p>
3.	up (+) / down (-) buttons	<ul style="list-style-type: none"> ◆ Assign ID numbers on VE8900 / VE8950 / VE8952 devices. ◆ Assign the source video (transmitter) for the receiver.
4.	Tx / Rx switch button	Press to switch control between a receiver and its corresponding transmitter.

Note:

- ◆ The VE8900 / VE8950 / VE8952 device automatically locks its panel when it idles for 1 minute. To unlock the panel, press and hold the **down (-)** button for 3 seconds.
- ◆ Tx / Rx LEDs and Tx / Rx Switch Button are only available on VE8900 / VE8950 / VE8952 receivers.

Assigning Sources Using the Device Panel

1. Assign an ID number to each of your VE8900R / VE8950R / VE8952 devices.
 - a) On a VE8900R / VE8950R / VE8952R device, make sure the control is switched to Rx, in which case the **Rx LED** lights up. If not, press the **Tx / Rx switch button**.
 - b) Use the **prev (+)** and **next (-)** buttons to assign an ID number to this receiver.
 - c) Repeat steps 1 (a) and 1 (b) on each of your VE8900R / VE8950R / VE8952R devices.
2. For a matrix setup, assign an ID number to each of your VE8900T / VE8950T / VE8952T devices.
 - a) On a VE8900T / VE8950T / VE8952T device, use the **prev (+)** and **next (-)** buttons to assign an ID number to this transmitter.
 - b) Repeat step 2 (a) on each of your VE8900T / VE8950T / VE8952T devices.
3. Assign source inputs to your VE8900R / VE8950R / VE8952R devices.
 - a) On a VE8900R / VE8950R / VE8952R device, press the **Tx / Rx switch button** to switch the control to Tx, in which case the **Tx LED** lights up.
 - b) Use the **prev (+)** and **next (-)** buttons to assign a source input to this receiver.
 - c) Repeat steps 3 (a) and 3 (b) on each of your VE8900R / VE8950R / VE8952R devices.

Chapter 4

Management

Overview

ATEN VE8900 / VE8950 / VE8952 HDMI over IP Video Extenders can be remotely and centrally managed using a built-in utility program, the ATEN VE Manager. Accessed through a web browser, this utility provides a central platform that allows you to do the following:

Feature	Details
Configure transmitter and receiver settings	See <i>Transmitter Settings</i> , page 55 and <i>Receiver Settings</i> , page 57.
Monitor transmitter and receiver statuses	See <i>Checking VE8900 / VE8950 / VE8952 Statuses</i> , page 52.
Create display templates	See <i>Creating a Video Wall Layout</i> , page 40.

Looking Up the Login IP Address

Follow the steps below to download IP Installer utility, and use the utility to look up the IP address of your VE8900 / VE8950 / VE8952 transmitter.

1. Go to the download link below:
<https://www.aten.com/global/en/supportcenter/downloads/>
2. Type in VE8900 / VE8950 / VE8952 in the field below “Download materials for other products” and press **OK**.
3. Scroll down the page and click either VE8900T / VE8950T / VE8952T or VE8900R / VE8950R / VE8952R.
4. Scroll down the page to find IP Installer zip file under “Software & Drivers”. Click the file to download.
5. Unzip and execute the downloaded IP Installer. The Network Device IP Installer screen appears.
6. Click **Enumerate** to search for ATEN devices in the network. The detected devices are shown in Device List.
7. Use the IP address of any VE8900 / VE8950 / VE8952 transmitter to log in VE Manager.

Looking Up the Login IP Address from OSD

Alternatively, you can obtain the IP address from the HDMI monitor connected to the VE8900 / VE8950 / VE8952 receiver. For more information, see the installation diagrams on *Connecting VE8900 / VE8950*, page 15, and *Connecting VE8952*, page 18.

Find My VE Extension

Chrome browser offers an extension called “Find My VE” for quick access to VE Manager login page.

1. For the extension application, go to the download link:
<https://www.aten.com/global/en/supportcenter/downloads/>
2. Type in VE8900 / VE8950 / VE8952 in the field below “Download materials for other products” and press **OK**.
3. Scroll down the page and click either VE8900T, VE8900R, or VE8952R.
4. Scroll down the page to find VE Browser zip file under “Software & Drivers”. Click the file to download.
5. Unzip and execute the downloaded VE Browser using Chrome.
6. After installing the extension, you may find it in Chrome’s extension page as shown in the example below:

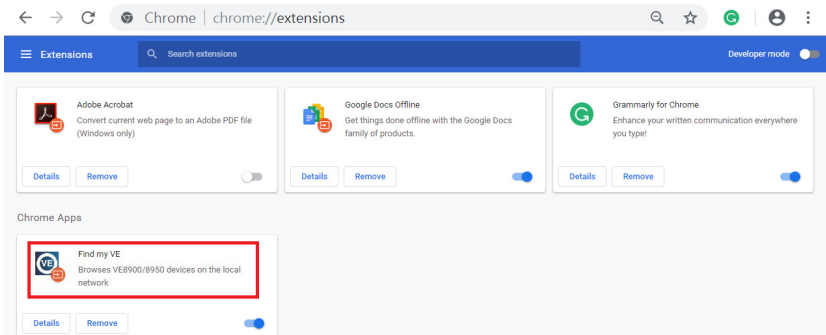

If you have it installed, you can get the extension application out in the start menu as shown in the example below:

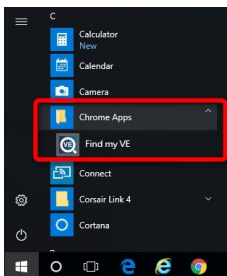

Clicking the extension application will bring up a window as shown below:

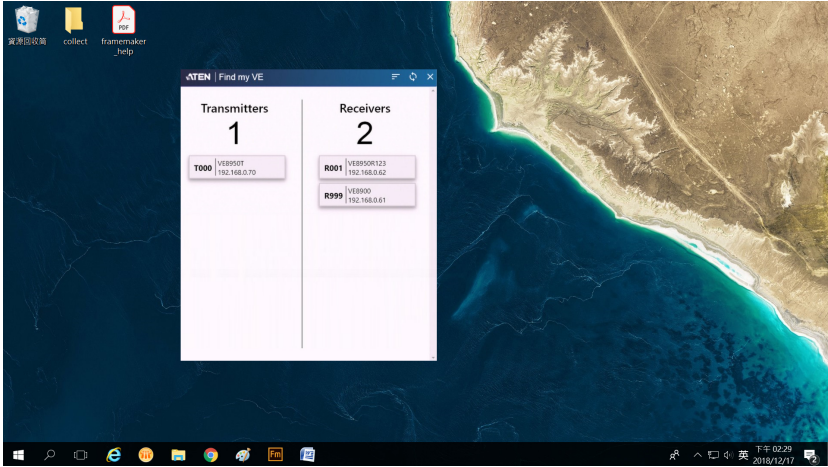

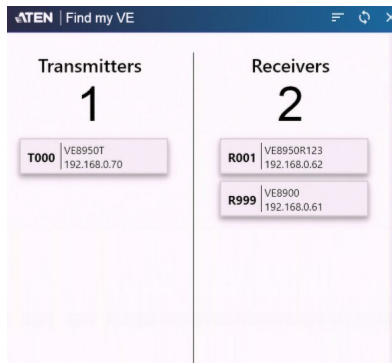

The window will display all the units within the network as a list.



Click the  icon (top right-hand corner) to refresh the list.

Use the scroll bar on the right to scroll through the list.

Use the  icon (top right-hand corner) to determine way the list is ordered.

Click the  icon to toggle between “By Name”, “By Id” and “By IP”, and the selected way is in bold character. For example, in the diagram above, the ID of the devices are in bold, which indicates that “By ID” is selected.

Click the bar of any of the shown devices to go to VE Manager.

Click “Close” to close the VE Browser application.

Start VE Manager using Find My VE Extension

You can go directly into VE Manager login page using the Find My VE Extension. To do so, follow the steps below:

1. In the Windows Start menu, click to select Find My VE.

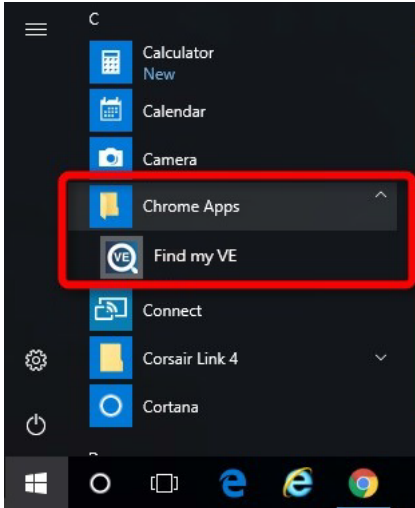

2. In the Find My VE window, click the bar of any of the shown devices and the system will open the VE Manager login page.

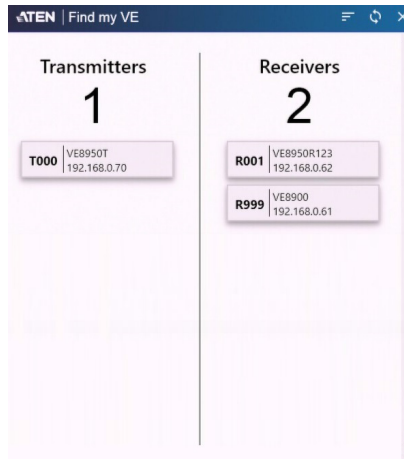

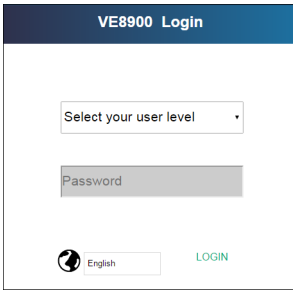

VE8900 Login

Select your user level ▾

Password

English LOGIN

Please refer to *Logging In and Configuring VE Manager* on page 31 for information about logging in.

Logging In and Configuring VE Manager

On a computer with web access, follow the steps below to log in VE Manager.

1. Open a web browser and type the IP address you obtained using IP Installer Utility. This screen appears.

2. Select **Administrator** for User Level and type **password** for the Password field. This screen appears upon first login.

Note: If you are the administrator, and are logging in for the first time, use the default Password: *password*. For security purposes, the system will prompt you to change the login password. The password must be different from your login password

3. Specify a date and time for the VE Manager using one of the following methods:
 - ◆ To keep the current date and time settings, select **Keep current time**.

- ◆ To adopt the date and time settings of the endpoint used to access VE Manager, select **Sync with computer time**.
 - ◆ To specify a different date and time, type the desired date and time. Make sure the date is typed in this format: YYYY/MM/DD.
4. Click **NEXT**. This screen appears. The setup wizard lists the VE8900 / VE8950 / VE8952 transmitters and receivers found in the network.

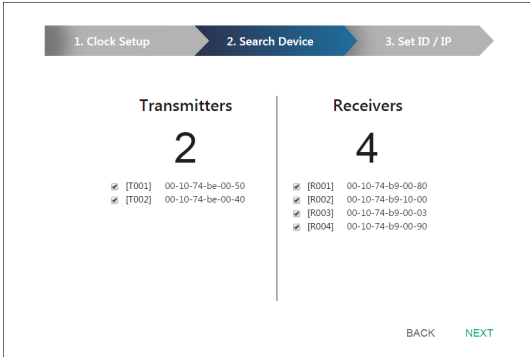

5. To configure device IP addresses, select the devices from the list, and then click **Next**. This screen appears.

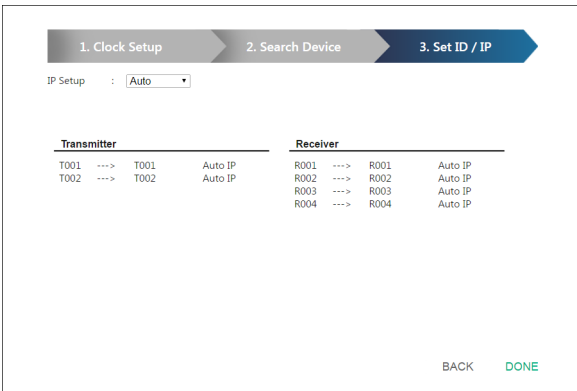

6. Click the **IP Setup** drop-down box to select a method for assigning IP addresses to the managed VE8900 / VE8950 / VE8952 devices.
- ◆ **Auto**: Select this option to have IP addresses automatically assigned by VE Manager.
 - ◆ **DHCP**: Select this option to have IP addresses dynamically assigned by a DHCP server.

- ◆ **Manual:** Select this option to designate IP addresses for the managed video extenders. For details, see the step below.
7. To manually assign IP addresses, follow the steps below.
- a) From the Set ID / IP page, select **Manual** for IP Setup. This screen appears.

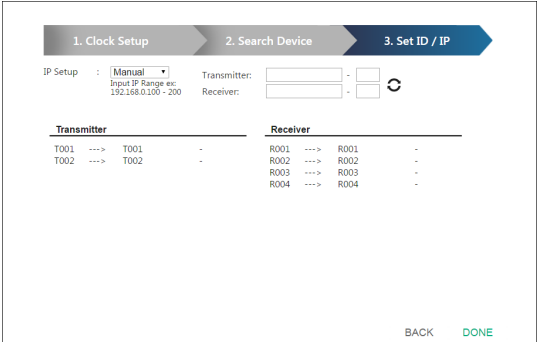

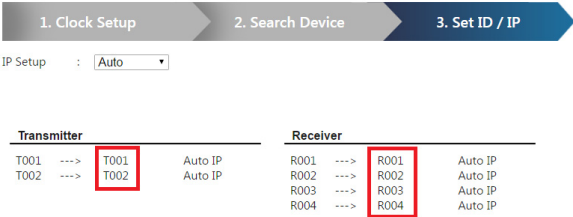

- b) In the Transmitter and Receiver fields, type valid IP address ranges.
- c) Click **Refresh** to start assigning IP addresses.
- d) When the assignment is complete, VE Manager displays the assigned IP addresses.
8. To re-assign device IDs, click and type a new ID for the target VE8900 / VE8950 / VE8952 device.



9. Click **Done**. The VE Manager’s main screen appears.

Note:

- ◆ For security reasons, ATEN recommends changing the password at first login. For details on account settings, see *Account Settings*, page 64.
- ◆ To access these settings again, click  from the VE Manager’s main screen, and then click .

The Main Screen

You can access the following controls from the VE Manager’s main screen.

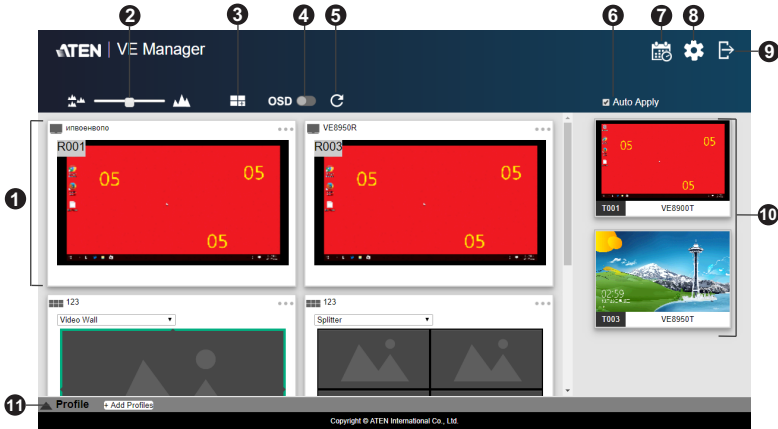

No.	Component	Description
1	Previews for Video Walls and Receivers	Shows a preview of created video walls, individual video receivers, and daisy chain setups. <ul style="list-style-type: none"> ◆ For details about creating video wall templates, see <i>Creating a Video Wall Layout</i>, page 40. ◆ For details about controls in a preview, see <i>Editing a Preview</i>, page 43.
2	Preview Size	Drag the slider bar to adjust the size of preview windows.
3	Create/Edit Video Wall	Click to create [or edit] video wall templates. For details, see <i>Assigning Sources Using VE Manager</i> , page 36.

No.	Component	Description
4	OSD	Globally enables or disables panel control of the VE8900 / VE8950 / VE8952 devices used in managed video walls. To enable or disable panel control of VE8900 / VE8950 / VE8952 devices for a single video wall, use the OSD setting for a preview window. For details, see Configuration Menu in <i>Editing a Preview</i> , page 43.
5	Refresh	Refresh / Update the Daisy Chain Status.
6	Auto Apply	Check to enable auto apply, where all the settings are automatically applied to the devices.
7	Profile Schedule	Click to enter profile scheduling page. For more information, please refer to <i>Setup Profile Schedules</i> on page 49.
8	System Settings	Click to access system settings, including the general settings, transmitter settings, receiver settings, firmware update, backup, and restore settings, and account settings. For more details, see Chapter 5, System Settings.
9	Log Out	Click to log out VE Manager.
10	Source List	Lists the display sources and identifies each source with its corresponding transmitter.
11	Profile Bar	Video wall profile for video wall display. For more information, please refer to <i>Profile</i> on page 44.

Apply / Auto Apply

If you wish to apply settings as you configure them, check **Auto Apply**.



Alternatively, if you wish to manually apply the settings, uncheck **Auto Apply** and use the **Apply** button. The button will light up to show a change was made.



Assigning Sources Using VE Manager

Follow the steps below to assign input sources using VE Manager.

1. On the main screen, identify the source you wish to be assigned in the “Source List” and the preview video walls / receivers.
2. Select and drag the source to the preview video walls / receivers.



3. When there is a display issue from the connected receiver, the specific receiver will be indicated in red from the preview.

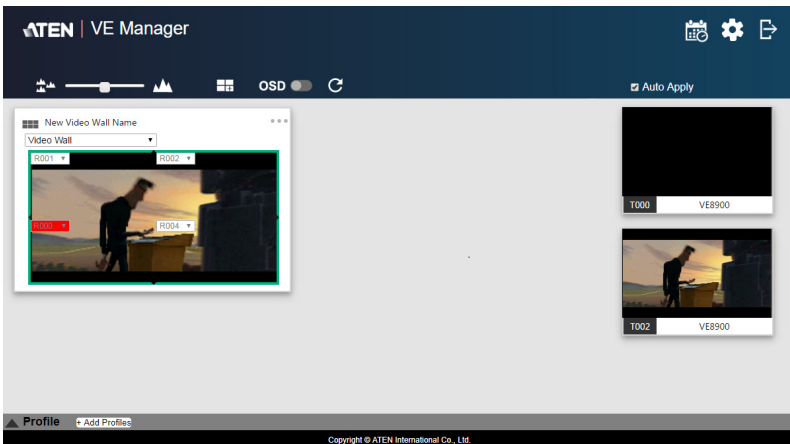

- 4. When there is a display issue from a single connected receiver, the preview is shown below.

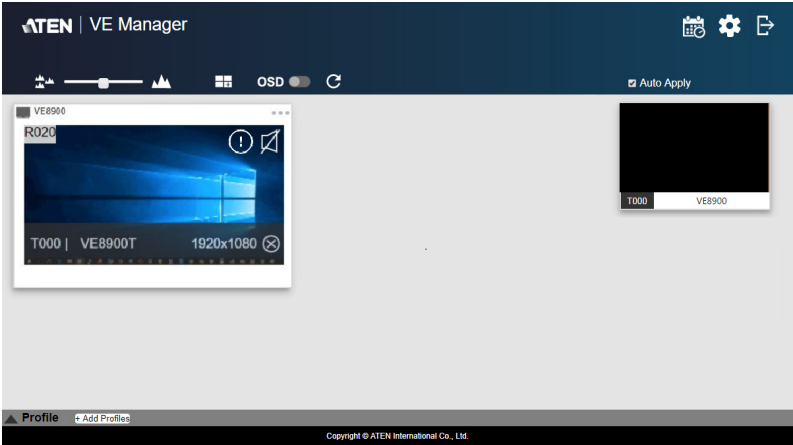

Alternatively, you can go into system settings to assign sources there. Follow the steps below:

- 1. From the main screen, click , and then click the **Receiver** tab. The managed VE8900 / VE8950 / VE8952 receivers appear.

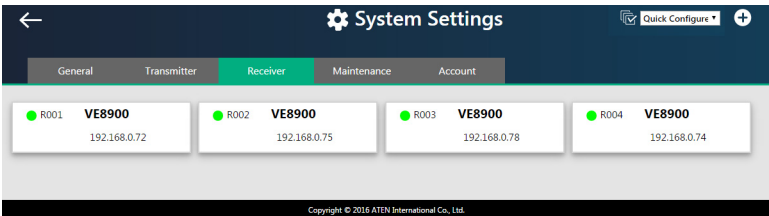

- 2. Assign a source for each of the VE8900 / VE8950 / VE8952 receivers.
 - a) Move the cursor to a receiver. A green arrow appears at the top right corner of the receiver preview window.
 - b) Click the green arrow. A drop-down menu appears.

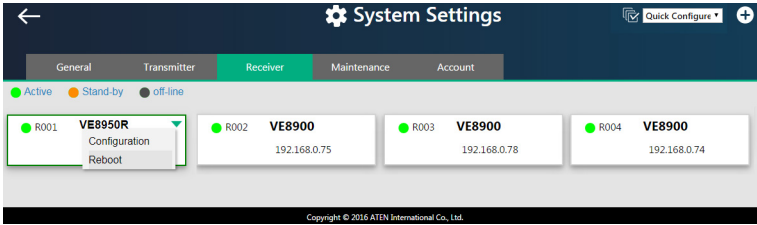

c) From the drop-down menu, click **Configuration**. This window appears.

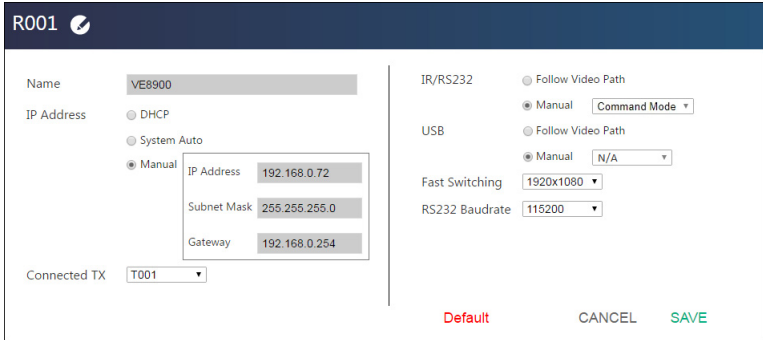

d) Click the **Connected Tx** drop-down arrow and select a Tx source.

e) Repeat steps 2 (a) to 2 (d) to assign sources for each of the receivers.

f) To reboot the VE8900 / VE8950 / VE8952, click the green arrow mentioned in step b), and click **Reboot**. This warning window appears.

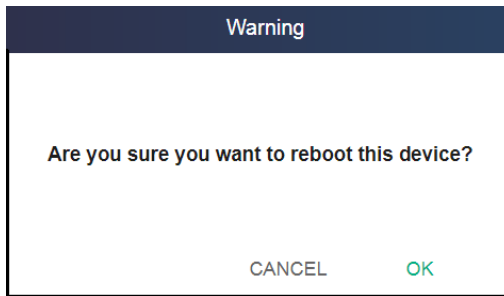

Configuring and Setting Up a Video Wall

To configure a video wall, follow the steps below.

1. Make sure you have created a video wall template for your specific needs. For detailed steps, see *Creating a Video Wall Layout*, page 40.
2. From the VE Manager’s main screen, drag and drop input sources from the Source List onto the created video wall layout. In the following example, the display source **T002** is assigned to this video wall layout, which has four monitors, **R001** to **R004**, merged to form an enlarged display of one source video.

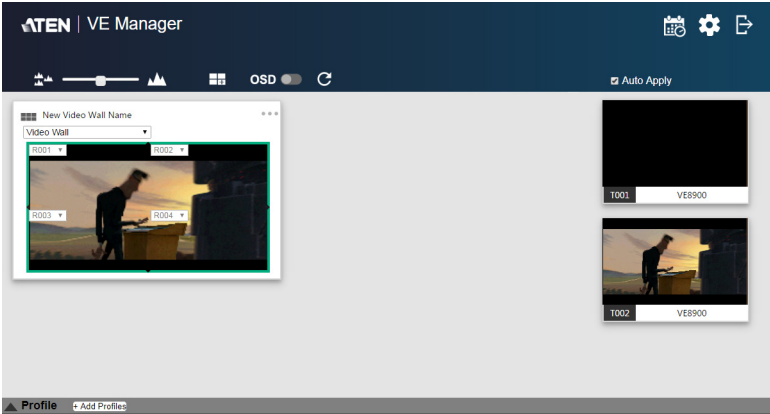

Note: For details on editing video wall settings, see *Editing a Preview*, page 43 and *Editing a Preview*, page 43.

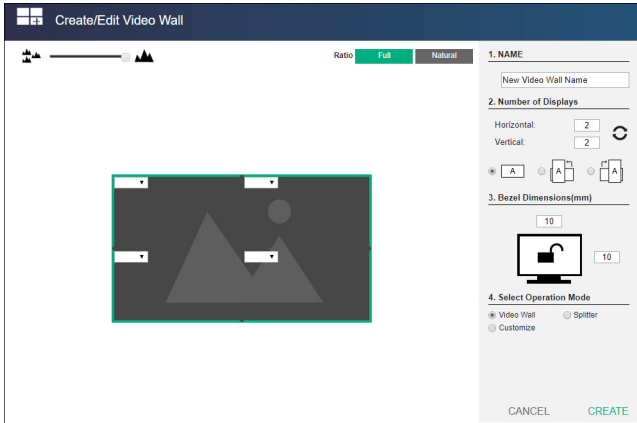

Creating a Video Wall Layout

1. To create a new layout, click **Create/Edit Video Wall** from the main screen. This window appears. A preview of the layout is shown in the middle.



2. Configure your video wall layout as required. Use the preview to help you visualize the layout.

Control	Description
Name of Video Wall	Type to name this video wall.
Number of Displays	<p>Define the following parameters.</p> <ul style="list-style-type: none"> ◆ Horizontal and Vertical: Click the drop-down boxes to select the number of displays for your video wall. Click Refresh to show a preview of your configuration. ◆ Display orientation: Select horizontal or vertical display. A vertical display is either a 90° clockwise or a 90° counter-clockwise rotation of the horizontal display.
Bezel Dimensions	Type to specify the top/bottom and right/left widths of the monitor frame. The value on the top is the total of the top and bottom bezel, and the value on the right is the total of the left and right bezel.

Control	Description
Operation Mode	Select an operation mode for your video wall. <ul style="list-style-type: none"> ♦ Video Wall: Select this option to set up a video wall. ♦ Splitter: Select this option to set up a display of identical content on multiple monitors. ♦ Customized: Select this option to create a customized display. Click New layout in the list to rename this template.
	Click and hold the slider bar to enlarge or reduce the size of preview windows.
	Use this button to merge displays. Click to select the desired monitors from the layout preview and click the button to merge the monitors.
	Use this button to separate already merged monitors. Select a merged monitor from the layout preview, and then click the button.
Ratio <input checked="" type="radio"/> Full <input type="radio"/> Natural	Full: Click to display source videos in full extension. Natural: Click to displays source videos in their original aspect ratio.

- From the preview area, click the drop-down boxes to define the output receiver for each monitor. An already selected, unavailable receiver is marked with an asterisk (*).

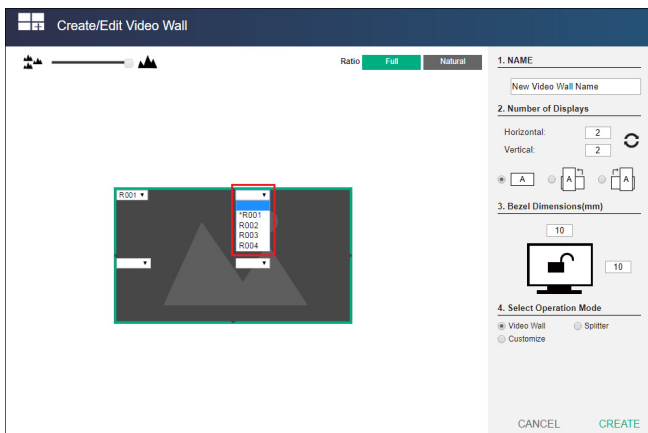

4. Click **CREATE**. The new video wall template is created.

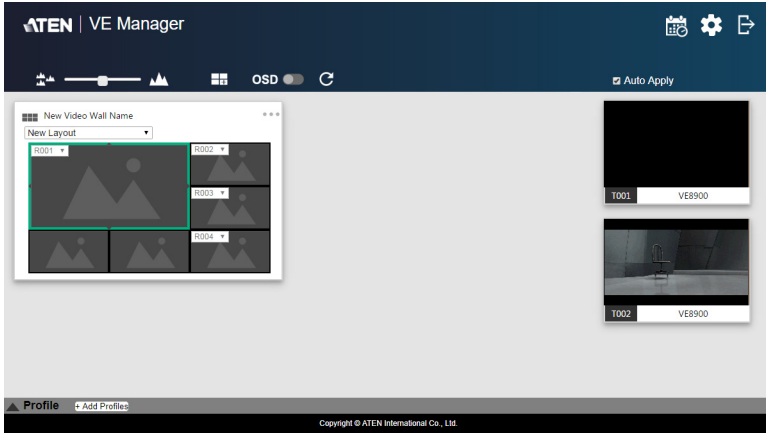

Editing a Video Wall Layout

To edit a video wall layout, from the VE Manager’s main screen, click the top-right corner of the layout you wish to edit, and then select **Edit**. For more details on video wall settings, see *Creating a Video Wall Layout*, page 40.

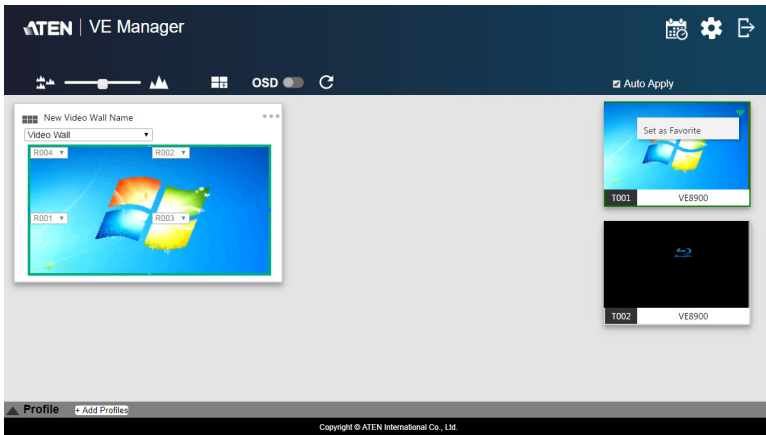

Editing a Preview

You can edit the following settings for a video wall layout.

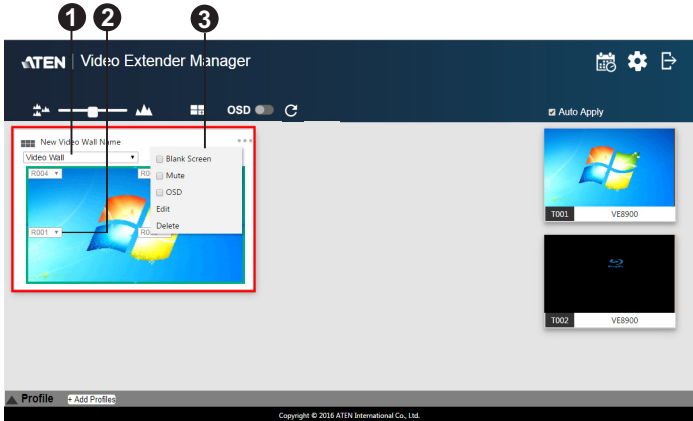

No.	Control	Description
1	Operation Mode	Click the drop-down list to select an operation mode.
2	Assigned Receiver	Displays the assigned receiver for the monitor. Tip: For an un-merged monitor, double-click the monitor to open up the settings page for the assigned receiver.
3	Configuration Menu	Click the top-right corner to access the following controls: <ul style="list-style-type: none"> ◆ Blank: Disables the display on this video wall. ◆ Mute: Disables audio transmission to this video wall. ◆ OSD: Enables or disables the panel control of all VE8900 / VE8950 / VE8952 devices for this video wall. ◆ Edit: Click to access the video wall layout settings. For more details on video wall settings, see <i>Creating a Video Wall Layout</i>, page 40. ◆ Delete: Click to remove this layout from VE Manager. For a receiver, this option is only available when it is offline.

Profile

After configuring video receiver / video wall settings, if you find that you would like to keep the current settings, you can save it as a profile. You can create different profiles and apply them manually, or you can set up profile schedules for switching video display at different times of a day, week or month.

Creating a Profile

Follow the steps below to create a profile.

1. On the main screen, click the profile arrow on the profile bar for the profile list shown below:

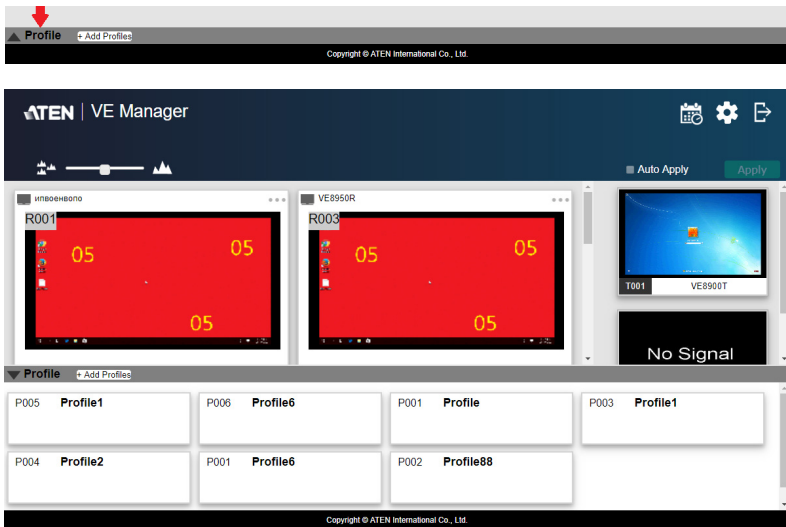

2. Click **+Add Profiles** for the page below:

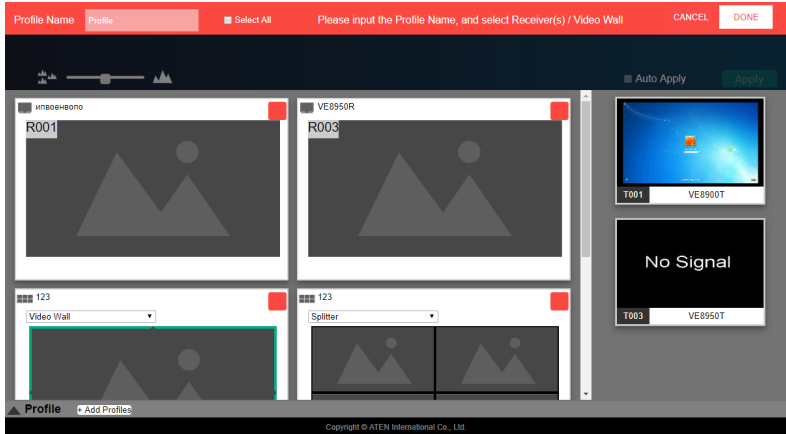

- ◆ **Profile Name:** Enter a profile name.
 - ◆ **Receivers / Video Walls:** Select the receivers / video walls you wish to be in this profile by checking the orange box. Alternatively, you can select all receivers / video walls by checking the **Select All** option.
3. Click **DONE** to complete the configuration.

Edit, Delete and Disconnect Profile

On the profile list, you can edit, delete and disconnect profiles.

Click to select the profile you wish to configure and a green arrow will appear. Click the green arrow for a drop-down menu of edit, delete and disconnect options.

Edit

To edit the profile, click the **Edit** option:

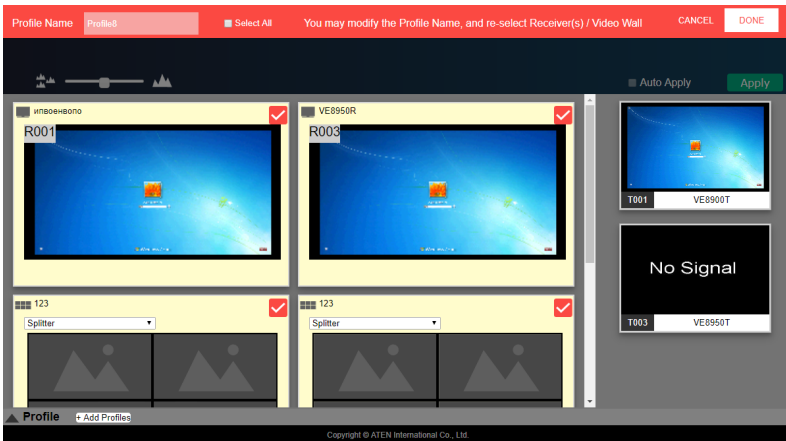

- ◆ **Profile Name:** Edit the profile name.
- ◆ **Receivers / Video Walls:** Select / de-select the receivers / video walls you wish to be in this profile by checking / unchecking the orange box. You can select / de-select all receivers / video walls by checking / unchecking the **Select All** option.

Click **DONE** to complete editing.

Delete

To delete a profile, click the **Delete** option:

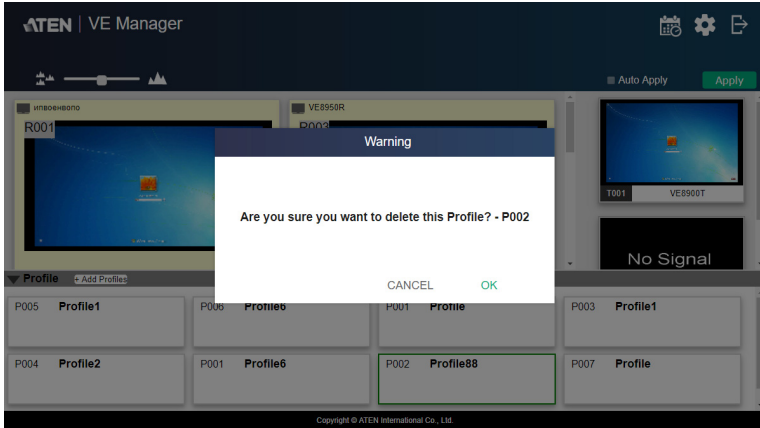

The system will ask if you would like to delete this profile. Click **OK** to proceed or click **CANCEL** to cancel.

Disconnect

To disconnect the current profile from the video wall, click **Disconnect**. The video wall should go blank.

Select / Apply Profile

After creating the profile, you can apply the settings of the profile to the video displays. Follow the steps below to apply the settings:

1. Bring up the profile list.
2. Click to select a profile and a preview will be shown:

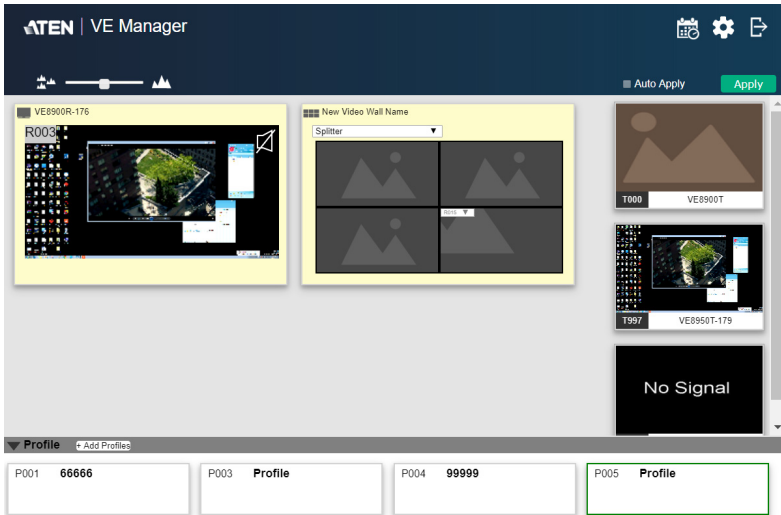

Copyright © ATEN International Co., Ltd.

The video receiver / video wall selected in the profile will be displayed. If the current video receivers / video walls show yellow background, it indicates that the video settings have not be applied. If the background is grey, it indicates that the video receivers / walls are not available. If the background is white, it indicates that the settings are currently applied to the system.

3. Click **Apply** to apply the settings of the profile.
4. When applied, the video settings will be shown on the main screen.

Setup Profile Schedules

Follow the steps below to setup profile schedules.

1. On the main screen, click the profile schedule icon  on the top right hand corner.

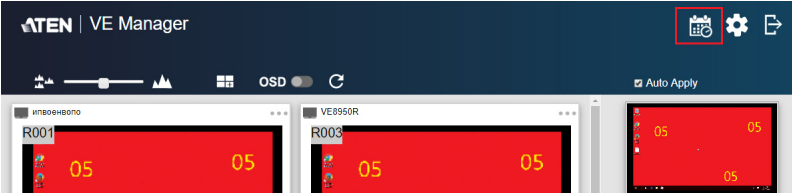

An example of profile schedule screen (with nothing planned) is shown below:

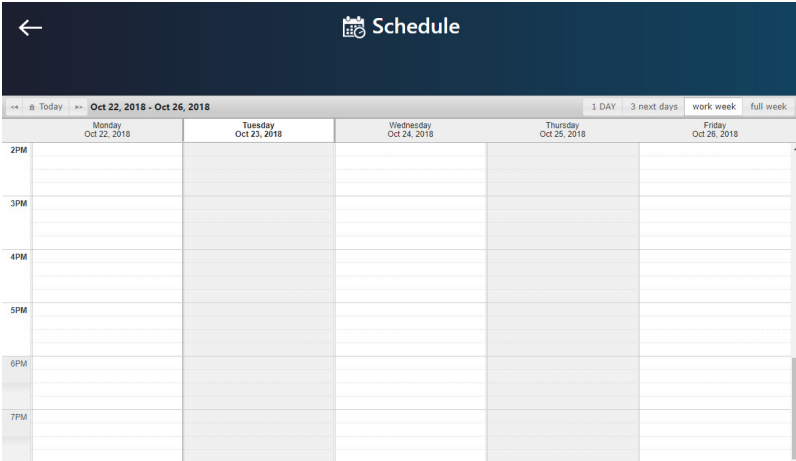

On this page, you can select to show current schedule of either “1 DAY”, “3 next days”, “work week” or “full week”.

2. Click to select the day and time period to setup the schedule. An example is shown below:

Edit / Add Schedule

Status Enable Disable

Profile

Start Date

End Date

Start Time :

End Time :

Repeat

CANCEL
SAVE

3. Edit / Add the schedule as required:

- ◆ **Status:** Enable or disable the schedule.
- ◆ **Profile:** Select a profile.
- ◆ **Start Date:** Select or enter a start date.
- ◆ **End Date:** Select or enter an end date.
- ◆ **Start Time:** Select or enter a start time.
- ◆ **End Time:** Select or enter an end time.
- ◆ **Repeat:** Select a repeat cycle for the schedule.
 - ◆ **Once:** Select this option to run this schedule only once.
 - ◆ **Daily:** Select this option to run this schedule everyday.
 - ◆ **Weekly:** Select this option to run this schedule every week. You can also select which days you wish the schedule to run in a week. The option is shown below:

Repeat

<input type="checkbox"/>	<input type="checkbox"/>	<input type="checkbox"/>	<input type="checkbox"/>	<input type="checkbox"/>
Monday	Tuesday	Wednesday	Thu	Friday
<input type="checkbox"/>	<input type="checkbox"/>			
Saturday		Sunday		

- ◆ **Monthly:** Select this option to run this schedule every month. you can also enter the days you wish the schedule to run in a month, or enter a range(s) for the schedule to run. Follow the on-screen instruction on how to enter the schedule here.

4. Click **SAVE** to save the schedule and an example is shown below:

←  Schedule

← Today → **Oct 22, 2018 - Oct 28, 2018** 1 DAY 3 next days work week full week

	Monday Oct 22, 2018	Tuesday Oct 23, 2018	Wednesday Oct 24, 2018	Thursday Oct 25, 2018	Friday Oct 26, 2018	Saturday Oct 27, 2018	Sunday Oct 28, 2018
2PM		02:30 pm to 03:00 pm S084 - Prof@88					
3PM							
4PM							
5PM							
6PM							
7PM							

Copyright © ATEN International Co., Ltd.

Managing VE8900 / VE8950 / VE8952 Devices

Checking VE8900 / VE8950 / VE8952 Statuses

You can check the statuses of your VE8900 / VE8950 / VE8952 devices using by clicking  from the main screen, and then the **Transmitter** or **Receiver** tab.

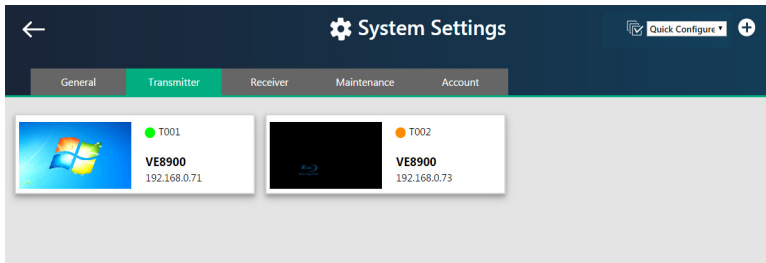

The status for a VE8900 / VE8950 / VE8952 device is indicated with a colored circle. See the table below for status indicators and the corresponding descriptions.

Indicator	Description
Green	The device is connected and active.
Orange	The device is on standby.
Grey	The device is offline.

Chapter 5

System Settings

Overview

The System Settings page allows you to specify device date and time, configure settings of connected VE8900 / VE8950 / VE8952 devices, upgrade device firmware, and back up the VE Manager's settings.

General Settings

The General tab contains the date, time, and panel lock settings.

The screenshot shows the 'System Settings' interface with the 'General' tab selected. The 'Time' section includes input fields for Year (2020), Month (02), and Day (03), with a timestamp of 2020/02/03 14:54:12. Below this are AM/PM (PM), Hour (02), and Minute (54) fields, along with a 'Set' button and a 'Sync with computer time' checkbox. The 'Pop-up OSD' section has 'Enable' and 'Disable' radio buttons. The 'Adaptive Video Quality' section has a dropdown menu set to 'Auto'. The 'Panel Lock' section has 'Enable', 'Auto', and 'Permanent' radio buttons.

To access the General tab, click  from the main screen, and then click the **General** tab.

- ◆ **Date and time:** Click and type the desired information and click **Set** to save the settings.
- ◆ **Sync with computer time:** If you wish to synchronize the time with the computer's time, check the checkbox and click **Set**.
- ◆ **Pop-up OSD:** When enabled, the OSD will be displayed when switching video source. The OSD will not be displayed when disabled.
- ◆ **Video Quality:** Click to select a video quality for display.
- ◆ **Panel Lock:**
 - ◆ Select **Permanent** to lock the panel control of all connected VE8900 / VE8950 / VE8952 devices. To unlock the panel of a single VE8900 / VE8950 / VE8952 device, uncheck the Enable checkbox.

- ◆ Select **Auto** to automatically lock the panel control of all connected VE8900 / VE8950 / VE8952 devices when it idles for 1 minutes. To unlock the panel of a single VE8900 / VE8950 / VE8952 device, press and hold the Down (-) button on the top panel for 3 seconds.
- ◆ Installation Wizard: Click  on the top-right corner to open up the installation wizard. For details, see *Logging In and Configuring VE Manager*, page 31.

Click **Apply** for the settings to take effect on the connected VE8900 / VE8950 / VE8952 devices.

Transmitter Settings

The Transmitter tab displays the managed VE8900 / VE8950 / VE8952 transmitter devices and provides access to the settings.

To access transmitter settings, follow the steps below.

1. From the main screen, click , and then click the **Transmitter** tab. The managed VE8900 / VE8950 / VE8952 transmitters appear.

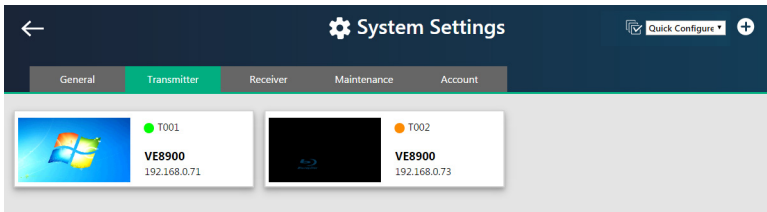

2. Move the cursor to a transmitter you wish to configure. A green arrow appears at the top right corner of the transmitter preview window.
3. Click the green arrow. A drop-down menu appears.

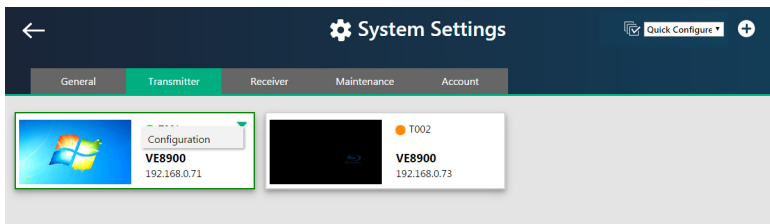

4. Click **Configuration**. This window appears.

 A screenshot of the 'T001 Configuration' window. The window is divided into two main sections. The left section contains:

- Name: VE8900
- IP Address: Radio buttons for DHCP, System Auto (selected), and Manual. A sub-window is open for Manual configuration with IP Address 169.254.3.151, Subnet Mask, and Gateway fields.

 The right section contains:

- Audio In: Radio buttons for HDMI and Analog (selected).
- EDID: A dropdown menu set to 'Auto'.
- RS232 Baudrate: A dropdown menu set to '115200'.
- HDCP: A checkbox labeled 'Enable' which is checked.

 At the bottom right of the window are three buttons: 'Default' (red), 'CANCEL' (grey), and 'SAVE' (green).

5. Configure the settings as required.
 - ◆ **Name:** Click to rename the transmitter.
 - ◆ **IP Address:** Specifies how the transmitter obtains its IP address. By default, this field is set to **System Auto**.
 - ◆ **DHCP:** Select this option to have the IP address automatically assigned by a DHCP server.
 - ◆ **System Auto:** Select this option to have the IP address automatically assigned by the VE Manager.
 - ◆ **Manual:** Select this option to designate an IP address for the transmitter. Manually type the IP Address, Subnet Mask, and Gateway for the device.
 - ◆ **Audio In:** Select your audio signal type.
 - ◆ **EDID:** After receiving EDID information from the connected display, the VE8900T / VE8950T / VE8952T analyzes this information and sets up the input source. Select an EDID mode that suits your needs.
 - ◆ **Default:** Sets up the input to an optimum configuration based on ATEN's predefined list of EDID.
 - ◆ **Auto:** Sets up the input to the best resolution of the connected displays.
 - ◆ **Manual:** Sets up the input to user's configuration.
 - ◆ **Remix:** Sets up the input to an optimum resolution of the connected displays.
 - ◆ **RS-232 Baud Rate:** Select a suitable baud rate.
 - ◆ **HDCP:** By default, HDCP is enabled for the VE8900T / VE8950T / VE8952T.
 - ◆ **Default:** Click to restore the transmitter's settings to default.
6. Click **SAVE** to keep the changes.

Receiver Settings

The Receiver tab displays managed VE8900 / VE8950 / VE8952 receiver devices and provides access to the settings.

To access receiver settings, follow the steps below.

1. From the main screen, click , and then click the **Receiver** tab. The managed VE8900 / VE8950 / VE8952 receivers appear.

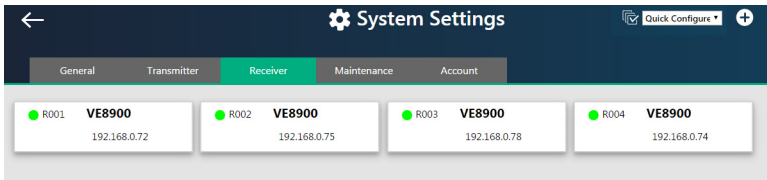

2. Move the cursor to a receiver you wish to configure. A green arrow appears at the top right corner of the receiver preview window.
3. Click the green arrow. A drop-down menu appears.

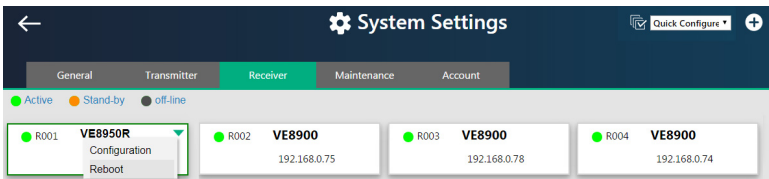

4. From the drop-down menu, click **Configuration**. This window appears.

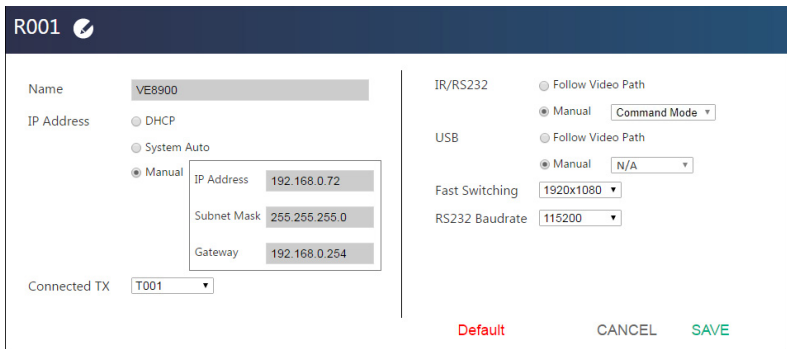

5. Configure the settings as required.

- ◆ **Name:** Type to name the receiver.
- ◆ **IP Address:** Specifies how the receiver obtains its IP address. By default, this field is set to **System Auto**.
 - ◆ **DHCP:** Select this option to have the IP address automatically assigned by a DHCP server.
 - ◆ **System Auto:** Select this option to have the IP address automatically assigned by the VE Manager.
 - ◆ **Manual:** Select this option to designate an IP address for the receiver. Manually type the IP Address, Subnet Mask, and Gateway for the device.
- ◆ **Connected Tx:** Defines the video source for this receiver.
- ◆ **IR/RS-232:** Sets the source for IR/RS-232 signals. By default, the IR and RS-232 are disabled (**Manual > N/A**).
 - ◆ **Follow Video Path:** Select this option to receive IR/RS-232 signals from the transmitter (**Connected Tx**) where the receiver obtains its video source.
 - ◆ **Manual:** Use this setting to select a different source for obtaining IR/RS-232 signals.
- ◆ **USB:** Sets the source for the connected USB devices.
 - ◆ **Follow Video Path:** Select this option to receive USB signals from the transmitter (**Connected Tx**) where the receiver obtains its video source.
 - ◆ **Manual:** Use this setting to select a different source for obtaining USB signals.
- ◆ **Fast Switching:** Click to define the resolution for fast switching.

Note: For best results, ATEN recommends setting this field to the same resolution with your video source and make sure this setting is identical on all VE8900 / VE8950 / VE8952 receivers.

- ◆ **RS-232 Baud Rate:** Click to define the baud rate for the receiver.
- ◆ **Default:** Click to restore the receiver's settings in this window to default.

6. Click **SAVE** to keep the changes.

Batch Configuration

A batch configuration option is available for both Transmitters and Receivers, and appears on the top right-hand corner of the page as **Quick Configuration**.

If you wish to adjust a particular setting for a group of devices, do the following:

1. Click **Quick Configuration** for a drop-down menu.

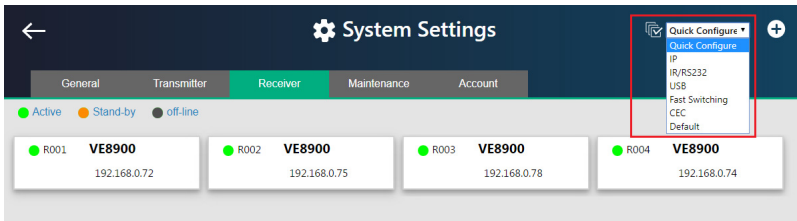
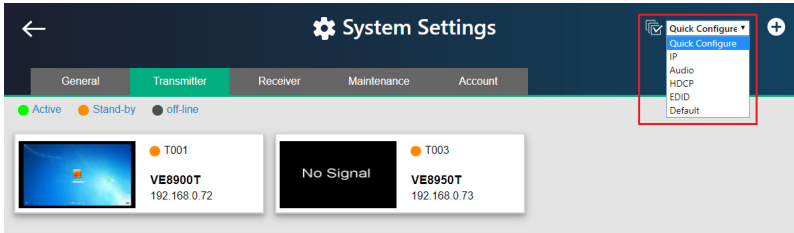

2. Select a setting you wish to configure.

The available options for the drop-down menu will depend on whether you're in the Transmitter or Receiver settings.

- ◆ For Transmitters, please refer to page 56.
- ◆ For Receivers, please refer to page 58.

The interface will allow you to select which devices you wish to configure.

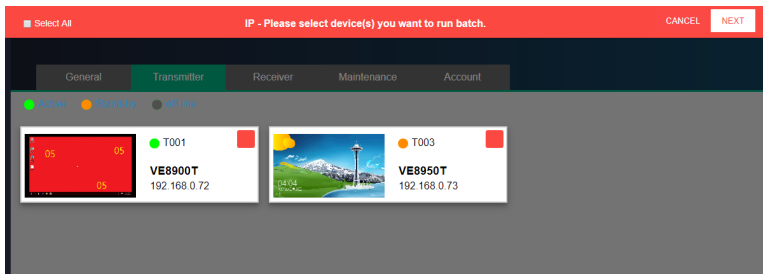

3. Check the devices you wish to configure or, if you wish to select all the devices on the list, check “Select All” (on the top left-hand corner) and click **NEXT**.

The Quick Configure window will appear and you can see each device’s current status.

A drop-down menu is available at the bottom of the window for the configuration.

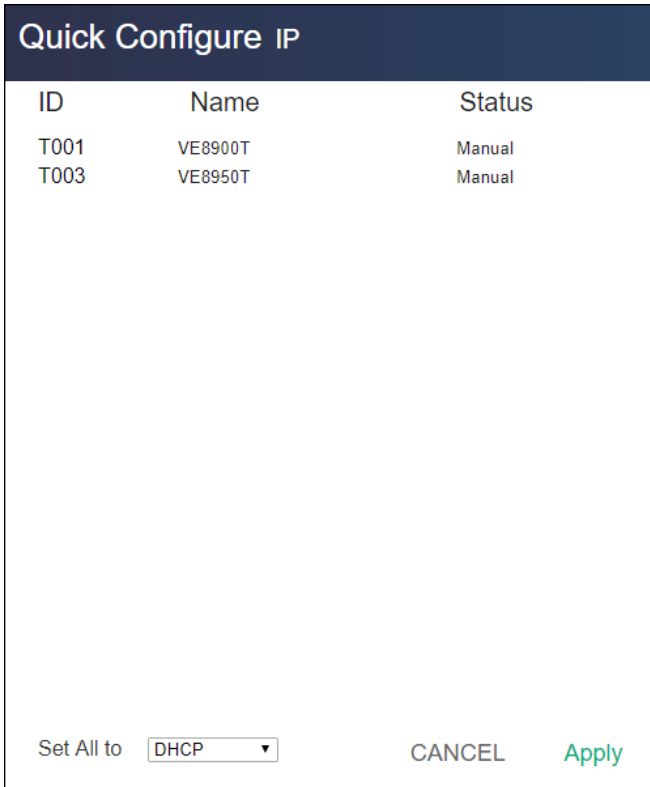

The screenshot shows a window titled "Quick Configure IP". It contains a table with three columns: ID, Name, and Status. Below the table, there is a "Set All to" label followed by a dropdown menu currently set to "DHCP". To the right of the dropdown are two buttons: "CANCEL" and "Apply".

ID	Name	Status
T001	VE8900T	Manual
T003	VE8950T	Manual

Set All to

4. Select the desired setting and click **Apply** to apply the setting to all the devices.

Maintenance

The Maintenance tab allows you to upgrade device firmware, back up transmitter and receiver layouts, and restore devices to previously backed up settings.

Upgrading VE8900 / VE8950 / VE8952 Device Firmware

To upgrade the VE8900 / VE8950 / VE8952 device firmware, follow the steps below.

1. From the main screen, click , and click the **Maintenance** tab. This screen appears. The Firmware Upgrade section lists the detected transmitter and receiver devices, and their firmware versions.

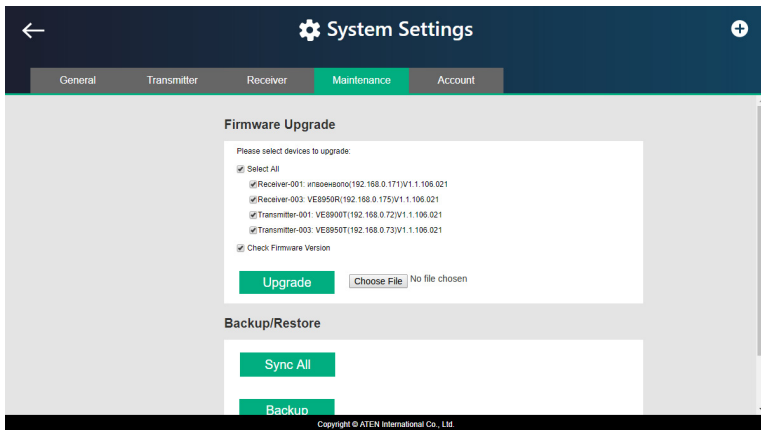

2. Click **Choose File** to locate a previously saved firmware file.
3. Click to uncheck any devices that do not require the upgrade.
4. By default, any upgrades that involve a version rollback will be ignored. To apply both upgrades and version rollbacks, uncheck **Check Firmware Version**.
5. Click **Upgrade** to start upgrading.

Synchronizing All Devices

When you wish to add or replace devices, click the **Sync All** button for the system to recognize the added / replaced device.

Backing Up VE8900 / VE8950 / VE8952 Device Settings

You can export transmitter and receiver layouts for backup or migration purposes.

1. From the main screen, click , and then click the **Maintenance** tab. This screen appears.

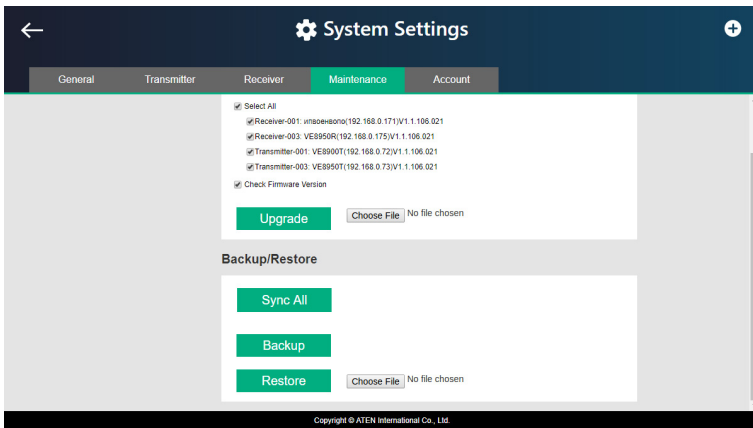

2. Click **Back up**. A confirmation message appears when the backup is complete.

Restoring VE8900 / VE8950 / VE8952 Device Settings

You can restore your VE Manager to a previously saved set of settings on transmitter and receiver layouts.

1. From the main screen, click , and then click the **Maintenance** tab. This screen appears.

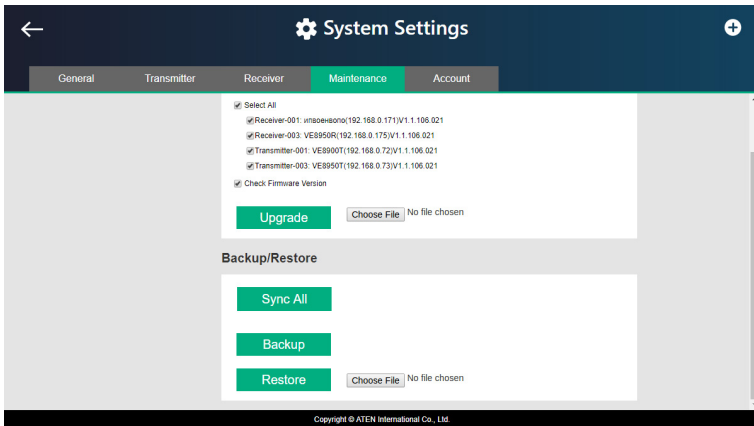

2. Click **Choose File** to locate a previously saved settings file.
3. Click **Restore** to start overwriting the settings to the VE Manager. A confirmation message appears when the backup is complete.

Recovery Mode

There are four conditions that require recovery mode:

- ◆ When a firmware upgrade is manually aborted.
- ◆ When the mainboard firmware upgrade fails.
- ◆ When the I/O firmware upgrade fails.
- ◆ The unit is not powered on with unknown reason

To set the VE8900 / VE8950 / VE8952 to recovery mode, do the following:

1. Press and hold the **Prev (+)** pushbutton.
2. Power on the VE8900 / VE8950 / VE8952.

Account Settings

VE Manager contains two account levels, the *Administrator* and the *User* level. The default passwords and privileges are detailed in the table below.

Account Level	Default Password	Privileges
Administrator	password	All settings
User	password	Source assignment and VE8900 / VE8950 / VE8952 receiver allocation on video wall layouts only

To change the default password, click  from the main screen, and then click the **Account** tab.

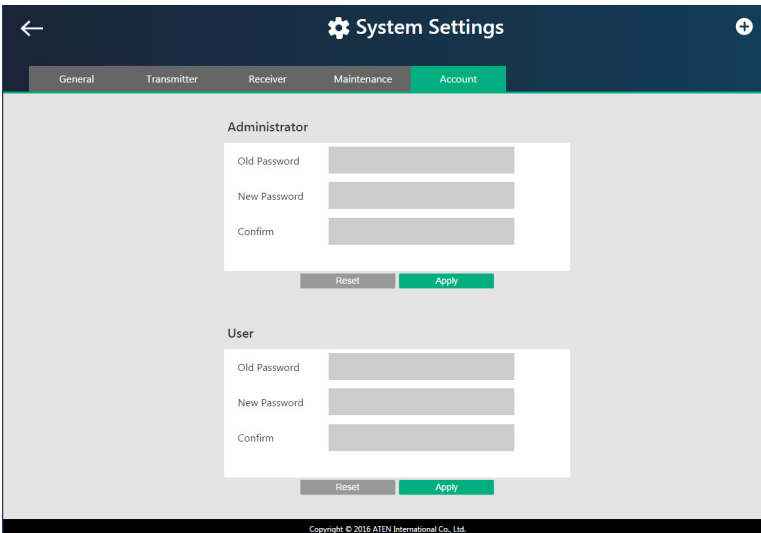

The screenshot shows the 'System Settings' application with the 'Account' tab selected. It displays two sections for password management: 'Administrator' and 'User'. Each section contains three input fields for 'Old Password', 'New Password', and 'Confirm', followed by 'Reset' and 'Apply' buttons.

Copyright © 2016 ATEN International Co., Ltd.

Chapter 6

CLI Commands

Overview

You can manage and configure the VE8900 / VE8950 / VE8952 devices using telnet, TCP, or RS-232 commands from a PC or an ATEN Control Box.

Before You Start

Make sure you have installed a PC or an ATEN Control Box to the Ethernet switch in your setup, as illustrated below:

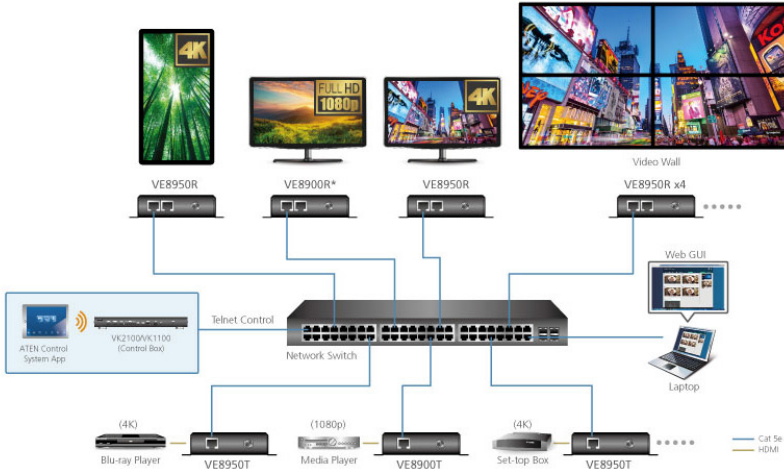

Note*: VE8900R supports up to 1080p. Downscaling from 4K to 1080p is not available on this model.

Executing Commands

The following instructions presume command operations using a PC. To execute commands using ATEN Control Boxes, see *ATEN Control System User Manual* for details. To execute a command, do the following:

1. On a connected PC, open a command prompt as administrator.
2. Depending on the supported command type for your PC, do the following to connect to your deployment.
 - ◆ Telnet connections

In the command prompt, type the IP address of any VE8900 / VE8950 / VE8952 receiver in your setup and use port **23**. For example:

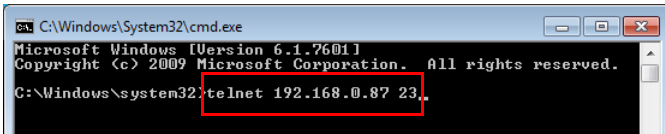

```

C:\Windows\System32\cmd.exe
Microsoft Windows [Version 6.1.7601]
Copyright (c) 2009 Microsoft Corporation. All rights reserved.

C:\Windows\system32>telnet 192.168.0.87 23..
  
```

- ◆ TCP connections

In the command prompt, type the IP address of any VE8900 / VE8950 / VE8952 receiver in your setup and use port **9138**. For example:

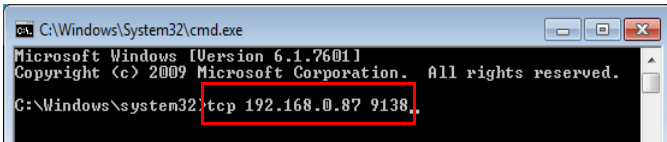

```

C:\Windows\System32\cmd.exe
Microsoft Windows [Version 6.1.7601]
Copyright (c) 2009 Microsoft Corporation. All rights reserved.

C:\Windows\system32>tcp 192.168.0.87 9138..
  
```

- ◆ RS-232 connections

In the VE Manager, set the IR/RS232 of all VE8900 / VE8950 / VE8952 receivers to **Manual** and select the **Command Mode** option.

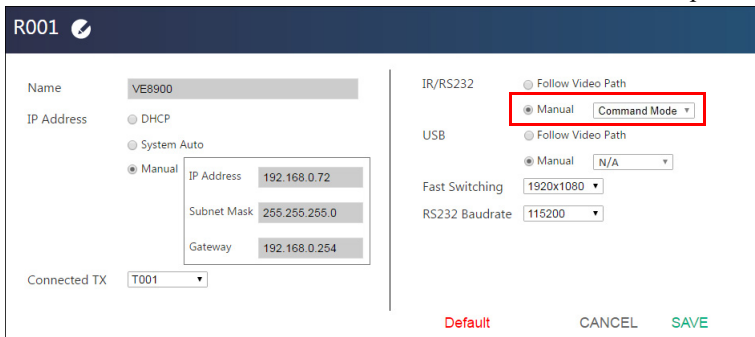

The screenshot shows the configuration page for device R001. The 'Name' field is set to 'VE8900'. Under 'IP Address', the 'Manual' radio button is selected, and the 'IP Address' field contains '192.168.0.72'. The 'Subnet Mask' is '255.255.255.0' and the 'Gateway' is '192.168.0.254'. The 'Connected TX' dropdown is set to 'T001'. On the right side, under 'IR/RS232', the 'Manual' radio button is selected and the 'Command Mode' dropdown menu is open, showing 'Command Mode' as the selected option. Other settings include 'USB' set to 'Manual', 'Fast Switching' set to '1920x1080', and 'RS232 Baudrate' set to '115200'. At the bottom right, there are buttons for 'Default', 'CANCEL', and 'SAVE'.

When the connection is established, the message “Welcome to CLI mode” appears.

3. Type the command you wish to execute.
For information on command syntax, see *Commands*, page 68.
4. Press **[Enter]** to execute the command.
5. When the command is successfully executed, the system returns a confirmation message.
6. To end the session, type **logout** in the command prompt and press **[Enter]**.

Commands

Guidelines

- ◆ The general form of a command is:
command name + parameter1 + parameter 2 + control 1 + control 2
- ◆ Always specify the command name first, followed by one or more parameters, and then the controls, if any.
- ◆ If you have two or more parameters, the order of these parameters among themselves does not affect the result of the operation. For example, both of the following commands execute the same task:
command name + parameter 1 + parameter 2
command name + parameter 2 + parameter 1
- ◆ If you have two or more controls, the order of these controls among themselves does not affect the result of the operation. For example, both of the following commands execute the same task:
command name + control 1 + control 2
command name + control 2 + control 1
- ◆ The command syntax uses the following notifications:

Notation	Description
+	Indicates a space in the command.
[]	Indicates optional items. Only type the information in the brackets, not the brackets themselves.
<argument>	Indicates the name of the value that the user must provide. Only type the information in the angle brackets, not the brackets themselves.
	Indicates two or more mutually exclusive choices in a command line. Only type one of the choices in the command line, not the symbol.

Switching Sources

To switch source on a display, type the command in this format:

sw + i<port> + o<port> + on | off + \r\n

Control	Description
i<port>	Indicates the device ID, MAC ID, or the IP address of the input source (VE8900 / VE8950 / VE8952 transmitter) device.
o<port>	Indicates the device ID, MAC ID, or the IP address of the output (VE8900 / VE8950 / VE8952 receiver) device. Omit this variable to assign the specified source to the display that you used to make the CLI connection.
on	Enables the specified command.
off	Disconnects from the current connection.
\r\n	Ends the command.

Examples

- ◆ To switch the source to a VE8900 transmitter with the IP address of 10.0.90.11 to the VE8900 receiver you used to make the CLI connection, type **sw i10.0.90.11 on**
- ◆ To switch the source to a VE8950 transmitter with the ID of 1 on a VE8950 receiver with the ID of 5, type **sw i1 o5 on**
- ◆ To stop source transmission from a VE8900 transmitter with the IP address of 10.0.70.43 to a VE8900 receiver with the ID of 3, type **sw i10.0.70.43 o3 off**

Switching Video, USB, RS-232, and/or IR Paths

Use this command to switch video, USB, RS-232 and/or IR transmission paths. To use this function, type the command in this format:

sw + i<port> + all | video | usb | serial | ir + o<port> + \r\n

Control	Description
i<port>	Indicates the device ID of the input source (VE8900 / VE8950 / VE8952 transmitter) device.
o<port>	Indicates the device ID of the output (VE8900 / VE8950 / VE8952 receiver) device.
all	Stands for all transmissions paths, including video, USB, and IR of the specified transmitter.
video	Stands for video path of the specified transmitter.
usb	Stands for USB path of the specified transmitter.
serial	Stands for RS-232 path of the specified transmitter.
ir	Stands for IR path of the specified transmitter.
\r\n	Ends the command.

Examples

- ◆ To switch the video path of a VE8900 transmitter with the ID of 3 to a VE8900 receiver with an ID of 4, type **sw i3 video o4**
- ◆ To switch the usb path of a VE8950 transmitter with the ID of 1 to a VE8950 receiver with an ID of 6, type **sw i1 usb o6**

Disabling Video, USB, RS-232, and/or IR Paths

Use this command to disable video, USB, RS-232 and/or IR transmission paths for the specified VE8900 / VE8950 / VE8952 receiver. To use this function, type the command in this format:

sw + o<port> + all | video | usb | serial | ir + off + \r\n

Control	Description
o<port>	Indicates the device ID of the output (VE8900 / VE8950 / VE8952 receiver) device.
all	Stands for all transmissions paths, including video, USB, and IR of the specified receiver.
video	Stands for video path of the specified receiver.
usb	Stands for USB path of the specified receiver.
serial	Stands for RS-232 path of the specified receiver.
ir	Stands for IR path of the specified receiver.
\r\n	Ends the command.

Example

- ◆ To disable the video, USB, RS-232, and IR paths for a VE8900 receiver with an ID of 4, type **sw o4 all off**

Displaying Port-Switching Alerts

Use this command to display an alert message in the command line interface whenever a port is switched via the VE Manager, the VE8900 / VE8950 / VE8952 device pushbuttons, or the IR remote control. To enable or disable this function, type the command in this format:

echo + on | off + \r\n

Control	Description
on	Sends an alert in the command prompt window to inform port switching configuration. For example, when the user assigns the VE8900T with the device ID of 2 to the VE8900R with the device ID of 3, the system send this message in the command prompt window: sw o2 i3 on
off	Disables the alert for port switching.
\r\n	Ends the command.

Looking Up System Settings

You can look up the following system settings using the list command:

- ◆ Video Wall IDs
- ◆ Device ID, MAC ID, IP address, firmware version, and device name of VE8900 / VE8950 / VE8952 transmitters and receivers

To look up system settings, type the command in this format:

list + rx | tx | device | videowall + \r\n

Control	Description
rx	Lists the system information of all VE8900 / VE8950 / VE8952 receivers in the environment, including the device IDs, MAC ID, IP addresses, firmware versions, and device names.
tx	Lists the system information of all VE8900 / VE8950 / VE8952 transmitters in the environment, including the device IDs, MAC ID, IP addresses, firmware versions, and device names.
device	Lists the system information of all VE8900 / VE8950 / VE8952 transmitters and receivers in the environment, including the device IDs, MAC ID, IP addresses, firmware versions, and device names.
videowall	Lists the video wall settings.
\r\n	Ends the command.

Configuring Video Wall Settings

To apply a layout to a video wall and assign sources for display, type the command in this format:

vw + f<video_wall_ID> + l<layout_ID> + [o<port>] + i<port> + on | off + /r/n

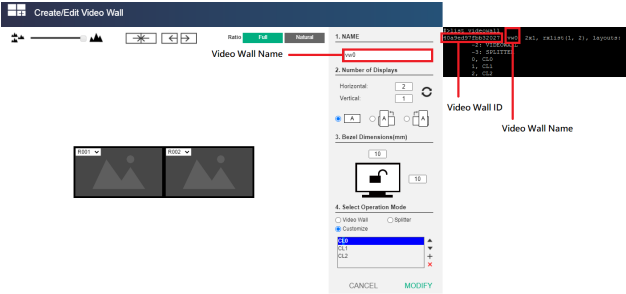
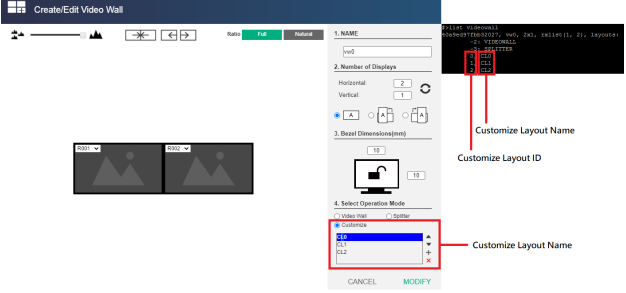
Control	Description
<p><video_wall_ID></p>	<p>Indicates the ID of the video wall on which you wish to display the specified layout and sources. You can also substitute this ID with the ID of any VE8900 / VE8950 / VE8952 receiver used in the target video wall. To look up video wall IDs, use the list command. For details, see <i>Looking Up System Settings</i>, page 73.</p> <p>Example:</p> 
<p>l<layout_ID></p>	<p>Indicates the ID of the layout that you wish to apply to the specified video wall. To look up layout IDs, use the list command. For details, see <i>Looking Up System Settings</i>, page 73. Omit this element when you want to use the same layout that is applied to the target video wall.</p> <p>Example:</p> 
<p>i<port></p>	<p>Indicates the device ID, MAC ID, or the IP address of the input (VE8900 / VE8950 / VE8952 transmitter) device you wish to use.</p>

Control	Description
o<port>	Indicates the device ID, MAC ID, or the IP address of the output (VE8900 / VE8950 / VE8952 receiver) device on which you wish display the specified source (i<port>). Note: If the specified layout contains a 4 displays, two of which are merged, you will need 3 pairs of o<port> + i<port> to indicate the source to be displayed on each display. Omit the o<port> element when specified layout does not contained any merged screens.
on	Enables the video wall setting configuration and display to the specified VE8900 / VE8950 / VE8952 receiver.
off	Disables the video wall setting configuration and display to the specified VE8900 / VE8950 / VE8952 receiver. Note: Please do not specify any i<port> element when using the off command.
\r\n	Ends the command.

Example

- ♦ To apply **Layout 1** to a video wall with the ID of **8c8f12e62d3c87ef**, and assign the source connected to VE8950T (device ID: **2**) to the video wall, where one of the display is connected to a VE8900R (IP address: **10.0.66.73**), type the following:
vw + f8c8f12e62d3c87ef + lLayout 1 + o10.0.66.73 + i2 + on

Muting VE8900 / VE8950 / VE8952 Receivers or Video Walls

To mute audio output on a VE8900R / VE8950R / VE8952R or a video wall, type the command in this format:

mute + o<port> | f<video_wall_ID> + on | off + /r/n

Control	Description
o<port>	Indicates the device ID, MAC ID, or the IP address of the output (VE8900 / VE8950 / VE8952 receiver) device you wish to mute. Use an asterisk (*) to mute all VE8900 / VE8950 / VE8952 receivers in the setup.
<video_wall_ID>	Indicates the ID of the video wall that you wish to mute. You can substitute this ID with the ID of any VE8900 / VE8950 / VE8952 receiver used in the target video wall. To look up video wall IDs, use the list command. For details, see <i>Looking Up System Settings</i> , page 73.
on	Mutes the specified VE8900 / VE8950 / VE8952 receivers or video walls.
off	Unmutes the specified VE8900 / VE8950 / VE8952 receivers or video walls.
\r\n	Ends the command.

Examples

- ◆ To mute a VE8900 receiver with the IP address 10.0.90.22, type **mute o10.0.90.22 on**
- ◆ To mute a video wall with the Video Wall ID 0, type **mute f0 on**
- ◆ To unmute a video wall with the Video Wall ID 1, type **mute f1 off**

Disabling a Video Output

To disable video output from a specific receiver or on a particular video wall, type the command in this format:

```
blankscreen + o<port> | f<video_wall_ID> + on | off + \r\n
```

Control	Description
o<port>	Indicates the device ID, MAC ID, or the IP address of the output (VE8900 / VE8950 / VE8952 receiver) device you wish to disable the video output from, or use * to disable video output from all VE8900 / VE8950 / VE8952 receivers in the setup.
<video_wall_ID>	Indicates the ID of the video wall on which you wish to disable the video output. You can substitute this ID with the ID of any VE8900 / VE8950 / VE8952 receiver used in the target video wall. To look up video wall IDs, see <i>Looking Up System Settings</i> , page 73.
on	Stops video output from the specified VE8900 / VE8950 / VE8952 receivers or on the specified video wall.
off	Allows video output from the specified VE8900 / VE8950 / VE8952 receivers or on the specified video walls.
\r\n	Ends the command.

Examples

- ◆ To disable video output on the VE8900 receiver with the IP address of 10.0.90.22, type **blankscreen o10.0.90.22 on**
- ◆ To enable video output on the video wall with the Video Wall ID 0, type **blankscreen f0 off**

Enabling / Disabling the OSD Display of a Receiver

To enable or disable the OSD display of a specified receiver, type the command in this format:

osd + o<port> | f<video_wall_ID> + on | off + \r\n

Control	Description
o<port>	Indicates the device ID, MAC ID, or the IP address of the output (VE8900 / VE8950 / VE8952 receiver) device for which you wish to display the OSD.
<video_wall_ID>	Indicates the ID of the video wall for which you wish to display the OSDs. You can substitute this video wall ID with the ID of any VE8900 / VE8950 / VE8952 receiver used in the video wall. To look up video wall IDs, see <i>Looking Up System Settings</i> , page 73.
on	Displays the OSD of the specified VE8900 / VE8950 / VE8952 receiver.
off	Hides the OSDs of the specified VE8900 / VE8950 / VE8952 receivers.
\r\n	Ends the command.

Examples

- ◆ To display the OSD of a VE8900 receiver with the IP address 10.0.90.22, type **osd o10.0.90.22 on**
- ◆ To hide the OSDs of the VE8900 / VE8950 / VE8952 receivers for a video wall with the Video Wall ID 0, type **osd f0 off**

Configuring the EDID Mode

To set the EDID mode of a specified VE8900 / VE8950 / VE8952 transmitter, type the command in this format:

```
edid + i<port> + <EDID_mode> + \r\n
```

Control	Description
i<port>	Indicates the device ID, MAC ID, or the IP address of the output (VE8900 / VE8950 / VE8952 transmitter) device connected to the source of the target display. Use an asterisk (*) to target all VE8900 / VE8950 / VE8952 transmitters in the environment.
<EDID_mode>	<p>Indicates the EDID mode you wish to set to the specified VE8900 / VE8950 / VE8952 transmitter. Valid inputs include default, remix, auto, and manual.</p> <ul style="list-style-type: none"> ◆ Default: Sets up the input to an optimum configuration based on EDID predefined by ATEN. ◆ Auto: Sets up the input to the highest resolution of the connected displays. ◆ Manual: Sets up the input to user's configuration. ◆ Remix: Sets up the input to an optimum resolution of the connected displays. <p>Note: For Manual and Remix EDID modes, make sure to select EDID from the Configuration Menu, see <i>Configuration Menu</i>, page 43.</p>
\r\n	Ends the command.

Example

- ◆ To set the EDID mode of a VE8900 transmitter with the device ID of 16 to auto, type **edid i016 auto**

Rebooting the VE8900 / VE8950 / VE8952

To reboot the VE8900 / VE8950 / VE8952, type the command in this format:

reset + a<port> | i<port> | o<port> + \r\n

Control	Description
a<port>	Indicates the MAC ID or the IP address of the target VE8900 / VE8950 / VE8952 transmitter or receiver.
i<port>	Indicates the device ID, MAC ID, or the IP address of the target input source (VE8900 / VE8950 / VE8952 transmitter) device. Use an asterisk (*) to target all VE8900 / VE8950 / VE8952 transmitters in the environment.
o<port>	Indicates the device ID, MAC ID, or the IP address of the target output (VE8900 / VE8950 / VE8952 receiver) device. Use an asterisk (*) to target all VE8900 / VE8950 / VE8952 receivers in the environment.
\r\n	Ends the command.

Examples

- ◆ To reboot the VE8900 transmitter with the IP address of 10.0.60.13, type **reset i10.0.60.13** or **reset a10.0.60.13**
- ◆ To reboot all VE8900 / VE8950 receivers, type **reset o***

Setting the Baud Rate

To set the baud rate of RS-232 serial transmission for VE8900 / VE8950 / VE8952 devices, type the command in this format:

```
baud + a<port> | i<port> | o<port> + <baud_rate> + \r\n
```

Control	Description
a<port>	Indicates the MAC ID or the IP address of the target VE8900 / VE8950 / VE8952 transmitter or receiver.
i<port>	Indicates the device ID, MAC ID, or the IP address of the target input source (VE8900 / VE8950 / VE8952 transmitter) device. Use an asterisk (*) to target all VE8900 / VE8950 / VE8952 transmitters in the environment.
o<port>	Indicates the device ID, MAC ID, or the IP address of the target output (VE8900 / VE8950 / VE8952 receiver) device. Use an asterisk (*) to target all VE8900 / VE8950 / VE8952 receivers in the environment.
<baud_rate>	Indicates the baud rate to which you wish to set the target devices. Valid inputs include 9600 , 19200 , 38400 , and 115200 .
\r\n	Ends the command.

Examples

- ◆ To set the baud rate of a VE8900 transmitter with the device ID of 3 to 115200, type **baud a3 115200**
- ◆ To set all VE8900 / VE8950 receivers to default, type **baud o* 9600**

Displaying Device Status

You can display the status of VE8900 / VE8950 / VE8952 transmitters or receivers, or the connection status of VE8900 / VE8950 / VE8952 transmitters to VE8900 / VE8950 / VE8952 receivers. To do this, type the command in this format:

read + [i<port>] | [o<port>] + \r\n

Control	Description
i<port>	Indicates the device ID, MAC ID, or the IP address of the target input source (VE8900 / VE8950 / VE8952 transmitter) device. Use an asterisk (*) to target all VE8900 / VE8950 / VE8952 transmitters in the environment.
o<port>	Indicates the device ID, MAC ID, or the IP address of the target output (VE8900 / VE8950 / VE8952 receiver) device. Use an asterisk (*) to target all VE8900 / VE8950 / VE8952 receivers in the environment.
\r\n	Ends the command.

Examples

- ◆ To look up the device status of all VE8900 / VE8950 / VE8952 transmitters, type **read i***
- ◆ To look up the device status of a VE8900 / VE8950 / VE8952 receiver with the IP address of 10.0.80.66, type **read o10.0.80.66**
- ◆ To look up the connection status of VE8900 / VE8950 / VE8952 transmitters to VE8900 / VE8950 / VE8952 receivers in the environment, type **read**

Setting the Audio Source of a Transmitter

To set the audio source for a specified VE8900 / VE8950 / VE8952 transmitter, type the command in this format:

```
audiomap + a<port> | i<port> + <source> + \r\n
```

Control	Description
a<port>	Indicates the MAC ID or the IP address of the target VE8900 / VE8950 / VE8952 transmitter.
i<port>	Indicates the device ID of the target input source (VE8900 / VE8950 / VE8952 transmitter) device. Use an asterisk (*) to target all VE8900 / VE8950 / VE8952 transmitters in the environment.
<source>	Indicates the audio source to which you wish to set the target transmitter. Valid inputs include analog and hdmi .
\r\n	Ends the command.

Examples

- ◆ To set the HDMI audio source of a VE8900 transmitter with the IP address of 10.0.90.19, type **audiomap a10.0.90.19 hdmi**
- ◆ To set the analog audio source of a VE8900 transmitter with the IP address of 10.0.90.19, type **audiomap a10.0.90.19 analog**

Restoring Factory Default Value

To reset the VE8900 / VE8950 / VE8952 devices, type the command in this format:

restore + a<port> | i<port> | o<port> + \r\n

Control	Description
a<port>	Indicates the MAC ID or the IP address of the target VE8900 / VE8950 / VE8952 transmitter or receiver. Use an asterisk (*) to target all VE8900 / VE8950 / VE8952 transmitters and receivers in the environment.
i<port>	Indicates the device ID of the target input source (VE8900 / VE8950 / VE8952 transmitter) device. Use an asterisk (*) to target all VE8900 / VE8950 / VE8952 transmitters in the environment.
o<port>	Indicates the device ID of the target output (VE8900 / VE8950 / VE8952 receiver) device. Use an asterisk (*) to target all VE8900 / VE8950 / VE8952 receivers in the environment.
\r\n	Ends the command.

Examples

- ◆ To reset the VE8900 transmitter with the IP address of 10.0.90.23, type **restore a10.0.90.23**
- ◆ To reset the VE8900 transmitter with the ID of 3, type **restore i3**
- ◆ To reset the VE8900 receiver with the ID of 5, type **restore o5**

Enabling / Disabling the HDCP of a Transmitter

To enable or disable the HDCP of a specified VE8900 / VE8950 / VE8952 transmitter, type the command in this format:

```
hdcp + a<port> | i<port> + on | off + \r\n
```

Control	Description
a<port>	Indicates the MAC ID or the IP address of the target VE8900 / VE8950 / VE8952 transmitter.
i<port>	Indicates the device ID, MAC ID, or the IP address of the target input source (VE8900 / VE8950 / VE8952 transmitter) device. Use an asterisk (*) to target all VE8900 / VE8950 / VE8952 transmitters in the environment.
on	Enables the HDCP of the specified VE8900 / VE8950 / VE8952 transmitter.
off	Disables the HDCP of the specified VE8900 / VE8950 / VE8952 transmitter.
\r\n	Ends the command.

Examples

- ◆ To enable the HDCP of a VE8900 transmitter with the IP address of 10.0.90.30, type **hdcp a10.0.90.30 on**
- ◆ To enable the HDCP of a VE8900 transmitter with the ID of 3, type **hdcp i3 on**

Setting the Fast Switch Output Resolution of a Receiver

To fast switch the output resolution of a specified VE8900 / VE8950 / VE8952 receiver using a pre-defined setting, type the command in this format:

fastswitch + a<port> | o<port> + off | <resolution> + \r\n

Control	Description
a<port>	Indicates the MAC ID or the IP address of the target VE8900 / VE8950 / VE8952 receiver.
o<port>	Indicates the device ID, MAC ID, or the IP address of the target output (VE8900 / VE8950 / VE8952 receiver) device. Use an asterisk (*) to target all VE8900 / VE8950 / VE8952 receivers in the environment.
off	Disables the fast switch output resolution of the specified VE8900 / VE8950 / VE8952 receiver.
resolution	Enables the fast switch output resolution of the specified VE8900 / VE8950 / VE8952 receiver using a pre-defined output resolution. Valid inputs include 4096x2160, 3840x2160, 1920x1200, 1920x1080, 1280x1024, 1280x800, 1280x720, 1152x972, 1024x768, 720x576, 720x480, 640x480, and 288x972.
\r\n	Ends the command.

Examples

- ◆ To enable the fast switch output resolution of a VE8900 receiver with the IP address of 10.0.90.56 and resolution of 3840 x 2160, type **fastswitch a10.0.90.56 3840x2160**
- ◆ To disable the fast switch output resolution of a VE8900 receiver with the IP address of 10.0.90.56, type **fastswitch a10.0.90.56 off**

Applying Profile via the Profile Name or ID

To apply a pre-configured profile via its profile name or ID, type the command in this format:

profile + f<profileid> + \r\n

Control	Description
f<profileid>	Indicates the pre-configured profile you wish to apply via its profile name or ID.
\r\n	Ends the command.

Example

- ♦ To apply a pre-configured profile with the profile name of test123, type **profile ftest123**

Enabling / Disabling the HDMI Blackscreen

To enable or disable the HDMI blackscreen of VE8900 / VE8950 / VE8952 receiver, type the command in this format:

hdmiblackscreen + on | off + \r\n

Control	Description
on	Enables the VE8900 / VE8950 / VE8952 receiver to output HDMI blackscreen when the VE8900 / VE8950 / VE8952 transmitter is disconnected. This is the default setting.
off	Enables the VE8900 / VE8950 / VE8952 receiver to output no signal when the VE8900 / VE8950 / VE8952 transmitter is disconnected.
\r\n	Ends the command.

Examples

- ♦ To enable the HDMI blackscreen of the VE8900 / VE8950 / VE8952 receiver, type **hdmiblackscreen on**
- ♦ To disable the HDMI blackscreen of the VE8900 / VE8950 / VE8952 receiver, type **hdmiblackscreen off**

This Page Intentionally Left Blank

Chapter 7

Mobile Control App

Overview



The VE8900 / VE8950 / VE8952 Mobile Control App is designed to help you conveniently switch sources/displays and apply and reschedule profiles for your VE8900 / VE8950 / VE8952 devices.

Requirements

Make sure your mobile device uses a supported version of the mobile operating system listed below before installing the app.

Mobile Operating System	Supported Version
iOS	10.0 or above
Android	6.0 or later

Installing and Configuring the App



1. Install the VE8900 / VE8950 / VE8952 Mobile Control App on a mobile device.
 - a) From the mobile device, tap the **App Store**  or **Google Play**  icon.
 - b) In the search box, type “VE8900 mobile control”.
 - c) Tap **VE8900 Mobile Control** and install the app.
2. From the mobile device, tap the **VE8900 Mobile Control App** icon.
3. Follow the on-screen instructions to:
 - ◆ enable the mobile device’s WiFi service.
 - ◆ connect the mobile device to the network where the video extenders are installed.

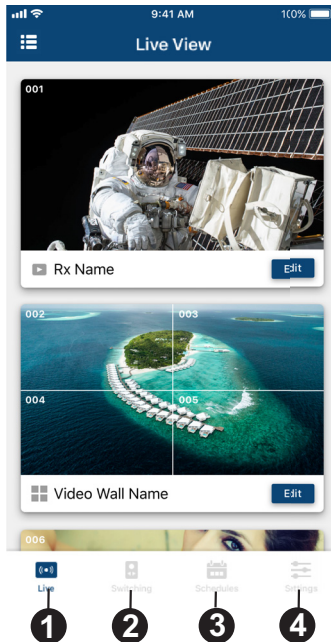

Main Page

When logged in, the VE8900 / VE8950 / VE8952 Mobile Control App defaults to the live view page. Use the icons at the bottom of the screen to access different sets of functions. Refer to the table below for an overview of the functions on each tab.

Note: If you are the administrator, and are logging in for the first time, use the default username and password: **admin / password**. For security purposes, the system will prompt you to change the login password. The password must be different from your login password





No.	Component	Description
1	 Live	Tap this icon to show live views of established video walls and receivers.
2	 Switching	Tap this icon to change display sources and target receivers.

No.	Component	Description
3	 Schedules	Tap this icon to configure the schedules of existing profiles. For details on creating a new profile, see <i>Profile</i> , page 44.
4	 Settings	Tap this icon to configure system settings or upgrade transmitter/receiver firmware.

Live Views

To see live views for your displays, follow the steps below.

1. In the VE8950 Mobile Control App, tap the **Live**  icon. A list of video walls and/or displays appear, along with their selected sources.
2. Scroll up and down to view the list. If you have installed new display devices or made changes to the settings, tap **Sync**  to refresh.

Switching a Source

1. In the VE8950 Mobile Control App, tap the **Live**  icon.
2. Tap any area on the receiver or the video wall for which you wish to change the source.

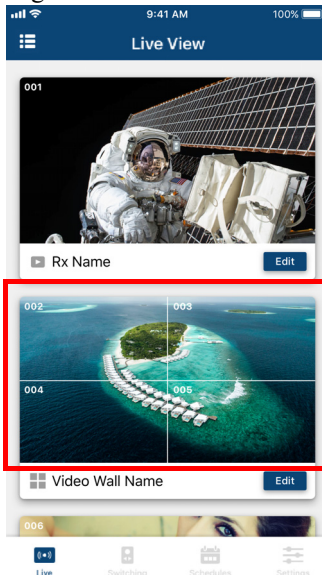

3. Tap the source you wish to change to. Currently used source is indicated with a red box, and the new source is in green.



4. Tap the tick icon on the selected source to apply the configuration.

Switching Multiple Sources and Displays

1. In the VE950 Mobile Control App, tap the **Switching**  icon. This screen appears.

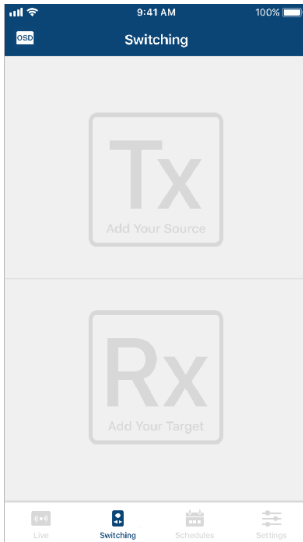

2. Select a source.
 - a) Tap **Tx** to add a source. A list of available transmitters appear.

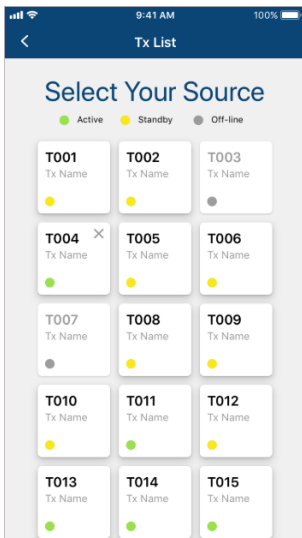

- b) Tap to select a transmitter. The selected device is indicated in green.
Tap again to cancel the selection.

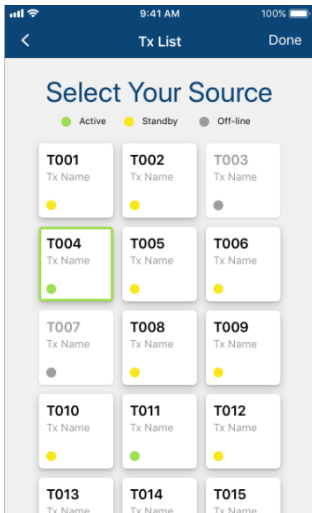

- c) Tap **Done** to add the device to the Tx List.

3. Select one or more displays. Tap **Rx** to add one or more Rx devices.
 - ◆ Selected Rx devices are indicated in green.
 - ◆ When you tap a device that is grouped with other Rx devices (for video wall or splitter applications), all the devices of the group will be indicated in green at the same time.

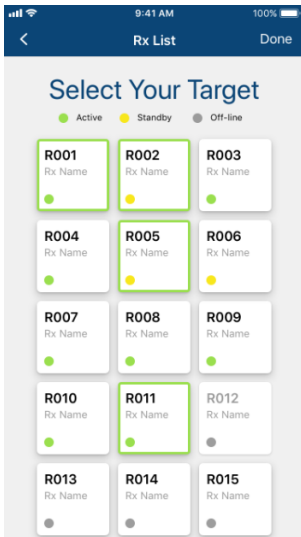

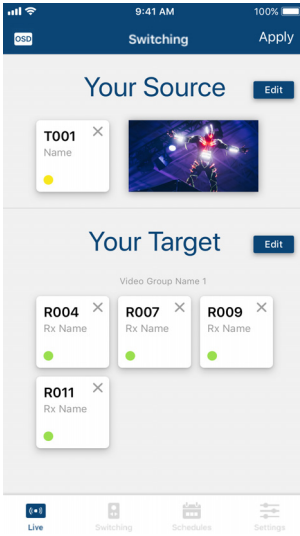

When you have finished configuring, the Tx and Rx lists should contain the devices you selected. For example:



4. To edit your selection, tap **Edit** to return to the Tx or Rx list.
5. Tap **Apply** to complete the configuration. The changes take effect immediately.

Changing the Operation Mode of a Video Wall/Display

1. In the VE8950 Mobile Control App, tap the **Live**  icon.
2. Find the video wall or the display that you wish to configure, and then tap the **Edit**  icon. This page appears.

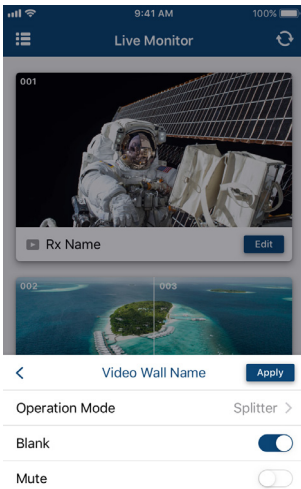

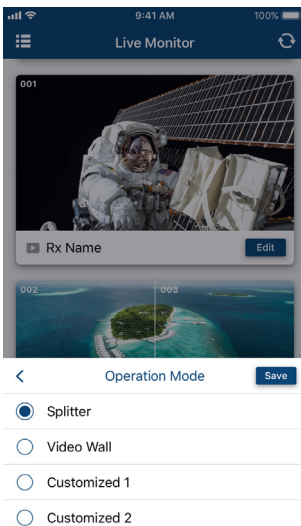

3. Tap **Operation Mode** to change the display setting.
For details on different operation modes, see *Creating a Video Wall Layout*, page 40.



Applying a Display Profile

If you already have display profiles configured using VE Manager, follow the steps below to apply a profile. For details on creating or editing a profile, see *Creating a Profile*, page 44 and *Edit, Delete and Disconnect Profile*, page 46.

1. In the VE8950 Mobile Control App, tap the **Live**  icon.
2. Tap  on the top-left of the screen. A list of profiles appears.

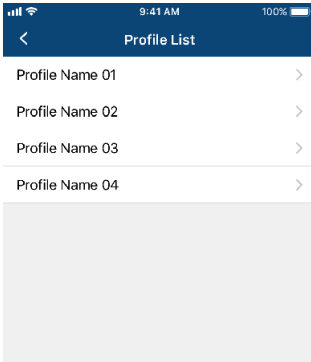

3. Tap any of the profile and follow the on-screen instructions to apply the profile.

Configuring the Profile Schedule

1. In the VE8950 Mobile Control App, tap the **Schedules**  icon. The schedules for the day appear.

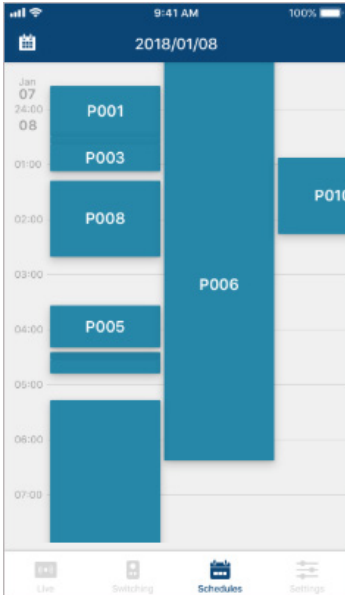

2. To change the display date, tap  on the top-left corner and select a date from the pop-up calendar.
3. Tap on the time zone that contains the profile you want to configure. All the profiles that run into or over the selected time zone are listed. For example, tap any where between 04:00 to 05:00. Four profiles can be configured.

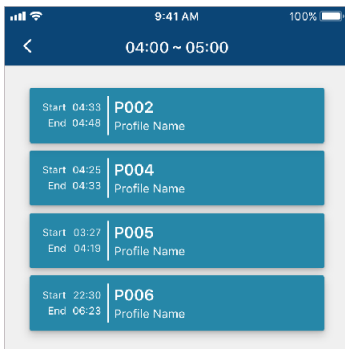

4. Tap a profile and follow the on-screen instructions to configure its Start Date, End Date, and Repeat mode.

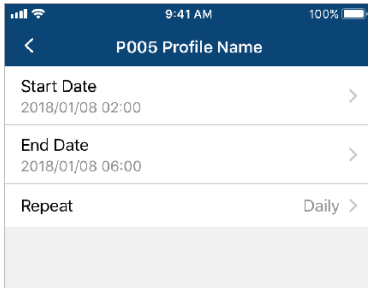

Note: Keep the Start Date and End Date within 24 hours. If you need to schedule a profile for more than 24 hours per repeat unit, use two profiles to resolve the issue.

System Settings and Status

You can use the Mobile Control App to find out if a newer firmware is available for the VE8900/VE8950 / VE8952 devices and configure the **Video Quality** and **Pop-up OSD** setting.

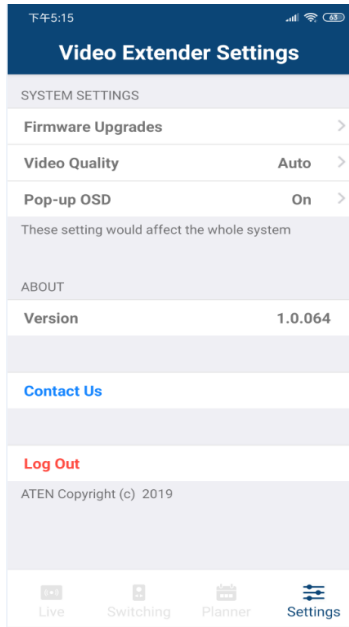

- ◆ **Firmware Upgrades:** Shows the firmware versions for the VE8900/VE8950 / VE8952 Tx and Rx devices and indicate if a newer firmware is available for each Tx/Rx device.
- ◆ **Video Quality:** Sets the video quality for displays.
- ◆ **Pop-up OSD:** When enabled, the OSD will be displayed when switching video source. The OSD will not be displayed when disabled.

Safety Instructions

General

- ◆ This product is for indoor use only.
- ◆ Read all of these instructions. Save them for future reference.
- ◆ Follow all warnings and instructions marked on the device.
- ◆ Do not place the device on any unstable surface (cart, stand, table, etc.). If the device falls, serious damage will result.
- ◆ Do not use the device near water.
- ◆ Do not place the device near, or over, radiators or heat registers.
- ◆ The device cabinet is provided with slots and openings to allow for adequate ventilation. To ensure reliable operation, and to protect against overheating, these openings must never be blocked or covered.
- ◆ The device should never be placed on a soft surface (bed, sofa, rug, etc.) as this will block its ventilation openings. Likewise, the device should not be placed in a built in enclosure unless adequate ventilation has been provided.
- ◆ Never spill liquid of any kind on the device.
- ◆ Unplug the device from the wall outlet before cleaning. Do not use liquid or aerosol cleaners. Use a damp cloth for cleaning.
- ◆ The device should be operated from the type of power source indicated on the marking label. If you are not sure of the type of power available, consult your dealer or local power company.
- ◆ To prevent damage to your installation it is important that all devices are properly grounded.
- ◆ Do not allow anything to rest on the power cord or cables. Route the power cord and cables so that they cannot be stepped on or tripped over.
- ◆ Position system cables and power cables carefully; Be sure that nothing rests on any cables.
- ◆ Never push objects of any kind into or through cabinet slots. They may touch dangerous voltage points or short out parts resulting in a risk of fire or electrical shock.

- ◆ Do not attempt to service the device yourself. Refer all servicing to qualified service personnel.
- ◆ If the following conditions occur, unplug the device from the wall outlet and bring it to qualified service personnel for repair.
 - ◆ The power cord or plug has become damaged or frayed.
 - ◆ Liquid has been spilled into the device.
 - ◆ The device has been exposed to rain or water.
 - ◆ The device has been dropped, or the cabinet has been damaged.
 - ◆ The device exhibits a distinct change in performance, indicating a need for service.
 - ◆ The device does not operate normally when the operating instructions are followed.
- ◆ Only adjust those controls that are covered in the operating instructions. Improper adjustment of other controls may result in damage that will require extensive work by a qualified technician to repair.

Rack Mounting

- ◆ Before working on the rack, make sure that the stabilizers are secured to the rack, extended to the floor, and that the full weight of the rack rests on the floor. Install front and side stabilizers on a single rack or front stabilizers for joined multiple racks before working on the rack.
- ◆ Always load the rack from the bottom up, and load the heaviest item in the rack first.
- ◆ Make sure that the rack is level and stable before extending a device from the rack.
- ◆ Use caution when pressing the device rail release latches and sliding a device into or out of a rack; the slide rails can pinch your fingers.
- ◆ After a device is inserted into the rack, carefully extend the rail into a locking position, and then slide the device into the rack.
- ◆ Do not overload the AC supply branch circuit that provides power to the rack. The total rack load should not exceed 80 percent of the branch circuit rating.
- ◆ Make sure that all equipment used on the rack – including power strips and other electrical connectors – is properly grounded.
- ◆ Ensure that proper airflow is provided to devices in the rack.
- ◆ Ensure that the operating ambient temperature of the rack environment does not exceed the maximum ambient temperature specified for the equipment by the manufacturer.
- ◆ Do not step on or stand on any device when servicing other devices in a rack.

Technical Support

International

- ◆ For online technical support – including troubleshooting, documentation, and software updates: <http://support.aten.com>
- ◆ For telephone support, see *Telephone Support*, page iv:

North America

Email Support		support@aten-usa.com
Online Technical Support	Troubleshooting Documentation Software Updates	http://www.aten-usa.com/support
Telephone Support		1-888-999-ATEN ext 4988

When you contact us, please have the following information ready beforehand:

- ◆ Product model number, serial number, and date of purchase
- ◆ Your computer configuration, including operating system, revision level, expansion cards, and software
- ◆ Any error messages displayed at the time the error occurred
- ◆ The sequence of operations that led up to the error
- ◆ Any other information you feel may be of help

Specifications

VE8900R / VE8950R / VE8952R

Function	VE8900R	VE8950R	VE8952R
Video Output			
Interfaces	1 x HDMI Type A Female (Black)		
Impedance	100 Ω		
Max. Distance	3 m (2L-7D03H)		
Video			
Max. Data Rate	Average: 150 ~ 500Mbps		
Compliance	HDMI, HDCP Compatible		
Max. Resolutions / Distances	Up to 1080p@100m (Cat 5e/6, point to point)	Up to 4K@100m (Cat 5e/6, point to point) *4K supported: 4096 x 2160 / 3840 x 2160 @ 30Hz (4:4:4)	
Audio			
Output	1 x HDMI Type A Female (Black) 1 x Mini Stereo Jack Female (Green)		
Connectors			
Unit to Unit	2 x RJ-45 Female		
Power	1 x DC Jack (Black) with locking	1 x DC Jack (Black) with locking 1 x RJ-45 (Power Over Ethernet PoE)	
Control			
IR	1 x Mini Stereo Jack Female (Black)		
RS-232	Connector	1 x Terminal Block, 3 x Pole	
	Baud Rate	19200	
	Data Bits	8	
	Stop Bits	1, no parity and flow control	
USB	2 x USB Type A Female (Black)		
Pushbuttons			
ID Number Selection	3 x Pushbuttons		
Power Consumption	DC5V:4.28W: 41BTU	DC5V:4.53W: 43BTU	DC5V:5.22W:46BTU DC48V:6.52W:52BTU

Function	VE8900R	VE8950R	VE8952R
Environmental			
Operating Temperature	0 - 40°C		
Storage Temperature	-20 - 60°C		
Humidity	0 x 80% RH, Non-Condensing		
Physical Properties			
Housing	Metal		
Weight	0.49 kg (1.08 lb)	0.68 kg (1.50 lb)	
Dimensions (L x W x H) with Bracket	14.02 x 12.30 x 3.06 cm (5.52 x 4.84 x 1.20 in)	17.02 x 14.69 x 3.00 cm (6.70 x 5.78 x 1.18 in)	
Dimensions (L x W x H) without Bracket	13.60 x 10.10 x 2.96 cm (5.35 x 3.98 x 1.17 in)	16.60 x 12.49 x 2.90 cm (6.54 x 4.92 x 1.14 in)	

Note: Supports 1920x1200@60Hz reduced blanking (ATEN Default EDID only).

VE8900T / VE8950T / VE8952T

Function	VE8900T	VE8950T	VE8952T
Video Input			
Interfaces	1 x HDMI Type A Female (Black)		
Impedance	100 Ω		
Max. Distance	3 m (2L-7D03H)		
Video			
Max. Data Rate	Average: 150 ~ 500Mbps		
Compliance	HDMI (4K), HDCP Compatible		
Max. Resolutions / Distances	Up to 1080p@100m (Cat 5e/6, point to point)	Up to 4K@100m (Cat 5e/6, point to point) *4K supported: 4096 x 2160 / 3840 x 2160 @ 60Hz (4:2:0) 4096 x 2160 / 3840 x 2160 @ 30Hz (4:4:4)	
Audio			
Input	1 x HDMI Type A Female (Black) 1 x Mini Stereo Jack Female (Green)		
Connectors			
Unit to Unit	1 x RJ-45 Female		
Power	1 x DC Jack (Black) with locking	1 x DC Jack (Black) with locking 1 x RJ-45 (Power Over Ethernet PoE)	
Control			
IR	1 x Mini Stereo Jack Female (Black)		
RS-232	Connector	1 x Terminal Block, 3 x Pole	
	Baud Rate	19200	
	Data Bits	8	
	Stop Bits	1, no parity and flow control	
USB	1 x USB Type B Female (White)		
Pushbuttons			
ID Number Selection	2 x Pushbuttons		
Power Consumption	DC5V:3.07W:14BTU	DC5V:3.08W:14BTU	DC5V:3.49W:16BTU DC48V:4.36W:20BTU

Function	VE8900T	VE8950T	VE8952T
Environmental			
Operating Temperature	0 - 40°C		
Storage Temperature	-20 - 60°C		
Humidity	0 x 80% RH, Non-Condensing		
Physical Properties			
Housing	Metal		
Weight	0.50 kg (1.10 lb)	0.67 kg (1.48 lb)	
Dimensions (L x W x H) with Bracket	14.02 x 12.30 x 3.06 cm (5.52 x 4.84 x 1.20 in)	17.02 x 14.69 x 3.00 cm (6.70 x 5.78 x 1.18 in)	
Dimensions (L x W x H) without Bracket	13.60 x 10.10 x 2.96 cm (5.35 x 3.98 x 1.17 in)	16.60 x 12.49 x 2.90 cm (6.54 x 4.92 x 1.14 in)	

Note: Supports 1920x1200@60Hz reduced blanking (ATEN Default EDID only).

Supported Browsers

Please see the table below for supported web browsers and the versions.

Web Browser	Supported Versions
Google Chrome	60.0.3112 or later
Mozilla Firefox	54.0.1 or later
Opera	46 or later

Limited Warranty

ATEN warrants its hardware in the country of purchase against flaws in materials and workmanship for a Warranty Period of two [2] years (warranty period may vary in certain regions/countries) commencing on the date of original purchase. This warranty period includes the [LCD panel of ATEN LCD KVM switches](#). Select products are warranted for an additional year (see [A+ Warranty](#) for further details). Cables and accessories are not covered by the Standard Warranty.

What is covered by the Limited Hardware Warranty

ATEN will provide a repair service, without charge, during the Warranty Period. If a product is defective, ATEN will, at its discretion, have the option to (1) repair said product with new or repaired components, or (2) replace the entire product with an identical product or with a similar product which fulfills the same function as the defective product. Replaced products assume the warranty of the original product for the remaining period or a period of 90 days, whichever is longer. When the products or components are replaced, the replacing articles shall become customer property and the replaced articles shall become the property of ATEN.

To learn more about our warranty policies, please visit our website:
<http://www.aten.com/global/en/legal/policies/warranty-policy/>

© Copyright 2022 ATEN® International Co., Ltd.
Released: 2022-05-30

ATEN and the ATEN logo are registered trademarks of ATEN International Co., Ltd. All rights reserved. All other brand names and trademarks are the registered property of their respective owners.