



Simply Better Connections

# ATEN PSD PP v4.0 Secure KVM Switch Series

2/4/8-Port USB DVI / HDMI /  
DisplayPort Single / Dual Display  
PP v4.0 Secure KVM Switch  
User Manual

## **EMC Information**

### FEDERAL COMMUNICATIONS COMMISSION STATEMENT:

This equipment has been tested and found to comply with the limits for a Class A digital device, pursuant to part 15 of the FCC Rules. These limits are designed to provide reasonable protection against harmful interference when the equipment is operated in a commercial environment. This equipment generates, and can radiate radio frequency energy and, if not installed and used in accordance with the instruction manual, may cause harmful interference to radio communications. Operation of this equipment in a residential area is likely to cause harmful interference in which case the user will be required to correct the interference at their own expense.

**Achtung:** Der Gebrauch dieses Geräts in Wohnumgebung kann Funkstörungen verursachen.

**Warning:** Operation of this equipment in a residential environment could cause radio interference

**FCC Caution:** Any changes or modifications not expressly approved by the party responsible for compliance could void the user's authority to operate this equipment.

This device complies with Part 15 of the FCC Rules. Operation is subject to the following two conditions:

- (1) this device may not cause harmful interference, and
- (2) this device must accept any interference received, including interference that may cause undesired operation.

### **KCC Statement**

유선 제품용 / A 급 기기 (업무용 방송 통신 기기)  
이 기기는 업무용 (A 급) 전자파적합기기로서 판매자 또는 사용자는 이  
점을 주의하시기 바라며, 가정 외의 지역에서 사용하는 것을 목적으로  
합니다.

## **RoHS**

This product is RoHS compliant.



### **HDMI Trademark Statement**

The terms HDMI, HDMI High-Definition Multimedia Interface, and the HDMI Logo are trademarks or registered trademarks of HDMI Licensing Administrator, Inc.

## China RoHS

产品中有害物质的名称及含量

部件名称 Parts Name	有害物质					
	铅 (Pb)	汞 (Hg)	镉 (Cd)	六价铬 (Cr(VI))	多溴联苯 (PBB)	多溴二苯醚 (PBDE)
电缆线/电源 Cable/Adaptor	X	O	O	O	O	O
印刷电路部件 PCBA	X	O	O	O	O	O
塑料/其它部件 Plastic /Others parts	O	O	O	O	O	O
金属部件 Metal parts	X	O	O	O	O	O

本表格依据 SJ/T 11364 的规定编制。  
 O：表示该有害物质在该部件所有均质材料中的含量均在 GB/T26572 规定的限量要求以下  
 X：表示该有害物质至少在该部件的某一均质材料中的含量超出 GB/T26572 规定的限量要求

表中标有“X”的情况,是按照欧盟 RoHS 采用了容许的豁免指标。 

在中国大陆销售的相应电子电器产品 (EEP) 都必须遵照中国大陆《电子电气产品有害物质限制使用标识要求》标准 (SJ/T11364) 贴上环保使用期限 (EPUP) 标签。该产品所采用的 EPUP 标签是基于中国大陆的《电子信息产品环保使用期限通则》标准。

## ***User Information***

### ***Online Registration***

Be sure to register your product at our online support center:

<https://eservice.aten.com/eServiceCx/Common/productRegister.do>

### ***Telephone Support***

For telephone support, call this number:

International	+886-2-8692-6959
China	+86-10-5255-0110
Japan	+81-3-5615-5811
Korea	+82-2-467-6789
North America	+1-888-999-ATEN ext 4988
United Kingdom	+44-8-4481-58923

### ***User Notice***

All information, documentation, and specifications contained in this manual are subject to change without prior notification by the manufacturer. The manufacturer makes no representations or warranties, either expressed or implied, with respect to the contents hereof and specifically disclaims any warranties as to merchantability or fitness for any particular purpose. Any of the manufacturer's software described in this manual is sold or licensed *as is*. Should the programs prove defective following their purchase, the buyer (and not the manufacturer, its distributor, or its dealer), assumes the entire cost of all necessary servicing, repair and any incidental or consequential damages resulting from any defect in the software.

The manufacturer of this system is not responsible for any radio and/or TV interference caused by unauthorized modifications to this device. It is the responsibility of the user to correct such interference.

The manufacturer is not responsible for any damage incurred in the operation of this system if the correct operational voltage setting was not selected prior to operation. PLEASE VERIFY THAT THE VOLTAGE SETTING IS CORRECT BEFORE USE.

## ***Package Contents***

The ATEN Secure KVM package consists of:

1 Secure KVM Switch

1 Power Cord

1 User Instructions\*

Check to make sure that all of the components are present and in good order.

If anything is missing, or was damaged in shipping, contact your dealer.

Read this manual thoroughly and follow the installation and operation procedures carefully to prevent any damage to the switch or to any other devices on the Secure KVM installation.

\*Please visit our website to download the most up to date version of the manual.

© Copyright 2011–2017 ATEN® International Co., Ltd.

Manual Version: v1.03

Manual Date: 2021-1-25

ATEN and the ATEN logo are registered trademarks of ATEN International Co., Ltd. All rights reserved.

All other brand names and trademarks are the registered property of their respective owners.

**Contents**

**EMC Information**..... ii

**China RoHS** ..... iii

**User Information** ..... iv

**Online Registration** ..... iv

**Telephone Support** ..... iv

**User Notice** ..... iv

**Package Contents** .....V

**About This Manual** ..... viii

**Overview**..... ix

**Conventions**..... x

**Product Information** ..... x

**Chapter 1**..... 1

**Introduction** ..... 1

    Overview..... 1

    Features..... 2

    Requirements ..... 4

    Console ..... 4

    Computers..... 4

    Cables ..... 4

    Operating Systems ..... 5

    Components ..... 6

    Front View (of ATEN Secure KVM Switch) ..... 6

    Rear View (of ATEN Secure KVM Switch) ..... 7

    Front View (of ATEN Remote Port Selector) ..... 11

**Chapter 2**..... 13

**Hardware Setup**..... 13

    Before You Begin ..... 13

    Stacking ..... 15

    Rack-Mount ..... 15

    Installation ..... 15

    Installation Diagram ..... 18

**Chapter 3**..... 19

**Operation** ..... 19

    Powering On ..... 19

    Manual Switching ..... 20

    Port ID Numbering ..... 20

LED Display .....	20
Chassis Intrusion Detection .....	22
Smart Card and CAC Reader.....	22
<b>Appendix .....</b>	<b>23</b>
Safety Instructions .....	23
General.....	23
Consignes de Sécurité.....	25
Général.....	25
Technical Support.....	27
International.....	27
North America .....	27
Specifications.....	28
Limited Warranty.....	35

**ATTENTION**

If the tamper-evident seal is missing or peeled, avoid using the product and contact your ATEN dealer.

If all front panel LEDs on the Secure KVM Switch (except Power) flash continuously, all Remote Port Selector (RPS) LEDs flash, or either enclosure appears breached, avoid using the product and contact your ATEN dealer.

The Secure KVM Switch and the Remote Port Selector (RPS) are equipped with active always-on chassis intrusion detection security. Any attempt to open the enclosure will permanently disable the switch/ RPS, and void the warranty.



**About This Manual**

**This user manual is intended for system administrators and end users.**

This user manual is provided to help you get the most from your ATEN Secure KVM Switch system. It covers all aspects of installation, configuration and operation. An overview of the information found in the manual is provided below.

This user manual covers the following ATEN Secure KVM Switches:

Configuration (with CAC function)			2-Port	4-Port	8-Port
PC Video Connection	Console Video Connection	No. of Displays			
DisplayPort	DisplayPort	Single	CS1182DP4C	CS1184DP4C	CS1188DP4C
		Dual	CS1142DP4C	CS1144DP4C	CS1148DP4C
HDMI	HDMI	Single	CS1182H4C	CS1184H4C	NA
		Dual	CS1142H4C	CS1144H4C	NA
DVI	DVI	Single	CS1182D4C	CS1184D4C	CS1188D4C
		Dual	CS1142D4C	CS1144D4C	CS1148D4C

Configuration (without CAC function)			2-Port	4-Port	8-Port
PC Video Connection	Console Video Connection	No. of Displays			
DisplayPort	DisplayPort	Single	CS1182DP4	CS1184DP4	CS1188DP4
		Dual	CS1142DP4	CS1144DP4	CS1148DP4
HDMI	HDMI	Single	CS1182H4	CS1184H4	NA
		Dual	CS1142H4	CS1144H4	NA
DVI	DVI	Single	CS1182D4	CS1184D4	CS1188D4
		Dual	CS1142D4	CS1144D4	CS1148D4



## ***Overview***

**Chapter 1, Introduction**, introduces you to the ATEN Secure KVM Switch system. Its purpose, features and benefits are presented, and its front and back panel components are described.

**Chapter 2, Hardware Setup**, provides step-by-step instructions for setting up your installation.

**Chapter 3, Operation**, explains the concepts involved in operating the ATEN Secure KVM Switch.

**An Appendix**, provides specifications and other technical information regarding the ATEN Secure KVM Switch.

## ***Conventions***

This manual uses the following conventions:

- |                                                                                   |                                                                                                                                                                                                            |
|-----------------------------------------------------------------------------------|------------------------------------------------------------------------------------------------------------------------------------------------------------------------------------------------------------|
| Monospaced                                                                        | Indicates text that you should key in.                                                                                                                                                                     |
| [ ]                                                                               | Indicates keys you should press. For example, [Enter] means to press the <b>Enter</b> key. If keys need to be chorded, they appear together in the same bracket with a plus sign between them: [Ctrl+Alt]. |
| 1.                                                                                | Numbered lists represent procedures with sequential steps.                                                                                                                                                 |
| ◆                                                                                 | Bullet lists provide information, but do not involve sequential steps.                                                                                                                                     |
| →                                                                                 | Indicates selecting the option (on a menu or dialog box, for example), that comes next. For example, Start → Run means to open the <i>Start</i> menu, and then select <i>Run</i> .                         |
|  | Indicates critical information.                                                                                                                                                                            |

## ***Product Information***

For information about all ATEN products and how they can help you connect without limits, visit ATEN on the Web or contact an ATEN Authorized Reseller. Visit ATEN on the Web for a list of locations and telephone numbers:

International     <https://www.aten.com/global/en/>

North America    <https://www.aten.com/us/en/>

This Page Intentionally Left Blank

# ***Chapter 1***

## ***Introduction***

### ***Overview***

The ATEN Secure KVM Switch series is NIAP<sup>1</sup>-certified and compliant with NIAP PPv4.0 (Protection Profile for Peripheral Sharing Device version 4.0)<sup>2</sup> requirements, satisfying the latest security requisites set by the U.S. Department of Defense for peripheral sharing devices. Compliance ensures maximum information security while sharing a single set of keyboard, mouse, monitor, speakers, and CAC (Common Access Card) Reader<sup>3</sup> between multiple computers. Conformity with Protection Profile v4.0 certifies that other USB peripherals cannot be connected to the console ports of the Secure KVM Switch, and that only a keyboard and mouse are accommodated, therefore providing high-level security, protection and safekeeping of data.

The ATEN Secure KVM Switch hardware security includes tamper-evident tape, chassis intrusion detection, and tamper-proof hardware, while software security features include restricted USB connectivity – non-HIDs (Human Interface Devices) or non-predefined CAC/HIDs are ignored when switching, an isolated channel per port that makes it impossible for data to be transferred between secure and unsecure computers, and automatic clearing of the keyboard and mouse buffer when switching port focus.

By combining physical security with controlled USB connectivity and controlled unidirectional data flow from devices to connected computers only, the ATEN Secure KVM Switch series offers you the means to consolidate multiple workstations of various security classification levels with one keyboard, monitor and mouse (KVM) console.

#### **Note:**

1. The National Information Assurance Partnership (NIAP) is a United States government initiative to meet the security testing needs of IT consumers and manufacturers. It is operated by the National Security Agency (NSA) and the National Institute of Standards and Technology (NIST).
2. The ATEN Secure KVM Switch series additionally satisfies Protection Profile version 4.0 for Peripheral Sharing Device (PSD).
3. USB 1.1 for keyboard, mouse connections, and USB 2.0 for CAC reader connection.

## Features

FEATURES		BENEFITS
■	2/4/8-Port USB DVI/HDMI/DisplayPort Single/Dual Display Secure KVM Switch*	Reduces the costs involved in controlling up to 8 Single/Dual Display computers while offering data isolation between shared peripherals and computers
■	Superior ultra high video resolution up to 4K UHD (3840 × 2160 @ 60Hz)**	Supports resolutions up to 3840 x 2160 @ 60Hz with crystal clear image quality
■	Video DynaSync™ – exclusive ATEN technology	ATEN Video DynaSync™ eliminates boot-up display problems and optimizes resolutions when switching between ports
■	DisplayPort AUX channel filtering (DisplayPort Secure KVM only)	Non-qualified auxiliary channel traffic such as MCCS and EDID write is rejected
■	NIAP PP PSD v4.0 certified	Provides the most advanced security features required by the latest Protection Profile (PP) v4.0 for Peripheral Sharing Device (PSD)
■	Pushbutton / Remote Port Selector (RPS)*** port selection and secure port switching	Port selection via pushbutton / Remote Port Selector (RPS) only to enhance security. Keyboard, Mouse, Video, Audio and CAC reader switch together for secure switching.
■	Channel Isolation	Isolated channel per port — makes it impossible for data to be transferred between computers
■	Shared peripherals and computer isolation	The always-on keyboard, mouse, and display EDID emulation ensures isolation between peripherals and connected computers.
■	Restricted USB connectivity	Non-authorized HIDs (Human Interface Devices) or non-predefined CAC will be rejected / ignored.
■	Unidirectional data flow	Secure design enables unidirectional data flow between devices and connected computers.
■	Administrative configuration and event log functions	Secure access for authorized administrator to audit KVM operation logs and secure configuration. (Please refer to the Administrator guide.)
■	Supports analogue audio (speaker only)****	Only unidirectional speaker data is allowed preventing the passage of the analogue audio by microphone input or line input.
■	Active always-on chassis intrusion detection	If physical tampering is detected, the switch or the Remote Port Selector becomes permanently inoperable.
■	Clears keyboard buffer when switching	Keyboard data buffer is automatically purged when switching KVM port focus.
■	Tamper-proof hardware	All integrated circuits are soldered directly to the circuit board to prevent tampering with the components.
■	Tamper-evident tape	Provides a visual indication of any attempt to gain access to the switch (or RPS) internal components.

■	Firmware non-reprogrammable	Prevents tampering and attempts to reprogram the switch's firmware.
■	Metal enclosure	Rugged metal enclosure.

**Note:**

\* HDMI Secure KVM Switch only has 2/4-port models.

\*\* HDMI Secure KVM Switch series supports console video output resolutions up to 4K @ 60 Hz.

DisplayPort Secure KVM Switch series supports console video output resolutions up to 4K @ 30 Hz.

DVI Secure KVM Switches offer 3840 x 2160 @ 30 Hz video output on compatible HDMI-interfaced monitors/computers with ATEN DVI-to-HDMI KVM cables.

\*\*\* Remote Port Selector is not supplied in the package and requires a separate purchase

\*\*\*\* Only analogue speaker data input is supported. The ATEN Secure KVM Switch does not convert digital audio to analogue audio.

## ***Requirements***

### ***Console***

- DVI (for DVI-interfaced Secure KVM), HDMI (for HDMI interfaced Secure KVM), or DisplayPort (for DisplayPort-interfaced Secure KVM) monitor capable of the highest resolution that you will be using on any computer in the installation
- USB mouse
- USB keyboard
- Speaker (Optional)
- USB Smart card or CAC (Common Access Card) reader (Optional)\*
- Remote Port Selector (Optional)\*\*

### ***Computers***

- A DVI/HDMI/DisplayPort video output connector
- A USB Type A port for keyboard and mouse
- A USB Type A port for Smart Card or CAC reader (Optional)\*
- A 3.5 mm jack Audio port for speaker (Optional)

### ***Cables***

The KVM cable sets which are specifically designed to work with this switch are not supplied in the package and require a separate purchase.

For security, do not connect any cable that has a microphone audio input or line in audio input.

#### **Note:**

\* Only applicable on the models with CAC function

\*\* Remote Port Selector is not supplied in the package and requires a separate purchase

## ***Operating Systems***

Suggested operating systems are shown in the table, below:

<b>OS</b>		<b>Version</b>
Windows		2000 / XP / Vista / 7 / 8 / 8.1 / 10
Linux	RedHat	6.0 and higher
	SuSE	8.2 and higher
	Mandriva (Mandrake)	9.0 and higher
UNIX	AIX	4.3 and higher
	FreeBSD	3.51 and higher
	Sun	Solaris 9 and higher
Novell	Netware	5.0 and higher
Mac		OS 9 and higher
DOS		6.2 and higher

**Note:** Supports Linux Kernel 2.6 and higher.



## Components

### Front View (of ATEN Secure KVM Switch)

#### CS1188D4C

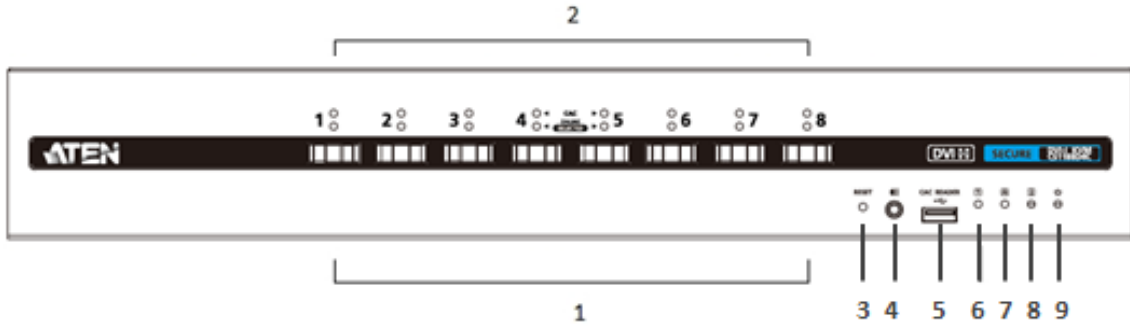

#### CS1142H4

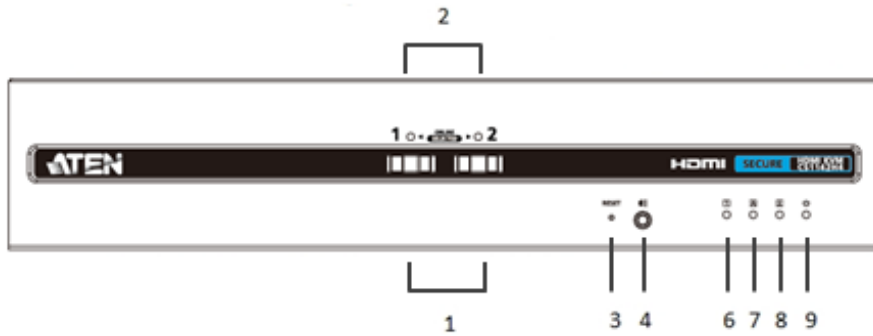

#### CS1184DP4C

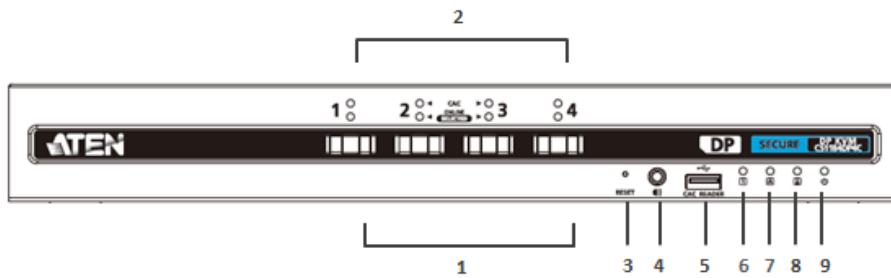

## Rear View (of ATEN Secure KVM Switch)

### CS1188D4C

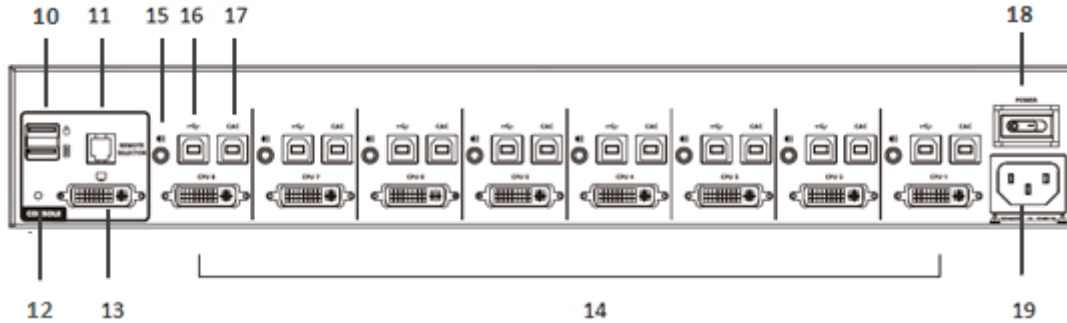

### CS1142H4

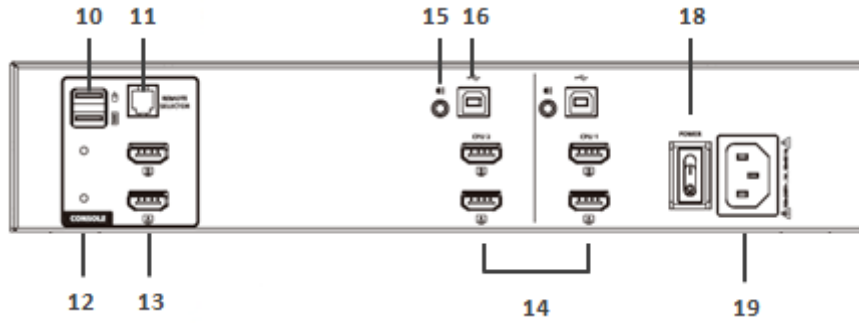

### CS1184DP4C

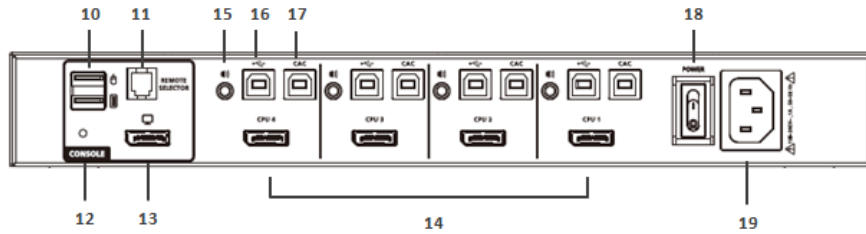

#### Note:

This user manual uses CS1188D4C, CS1142H4, CS1184DP4C to demonstrate each interface (DVI/HDMI/DisplayPort), port number (2/4/8- Port), CAC support (Yes/No), and number of displays (single/dual) supported by the ATEN Secure KVM Switch.

No.	Component	Description
1	Port Selection Pushbuttons	Pressing a Port Selection Pushbutton brings together the keyboard, mouse, video, audio, and CAC reader focus to the computer attached to its corresponding port.
2	Port and CAC LEDs	<p>The Port / CAC LEDs are located on front panel to indicate Port/CAC reader selection or connection status.</p> <p><b>Port LEDs (Lower row; Orange LEDs)</b></p> <ul style="list-style-type: none"> <li><input type="checkbox"/> Online – Lights dim orange to indicate that the computer attached to its corresponding port is connected and powered on.</li> <li><input type="checkbox"/> Selected – Lights bright orange to indicate that the computer attached to its corresponding port has the KVM focus.</li> <li><input type="checkbox"/> Warning - Flashes to indicate that a non-qualified USB HID device is connected to console USB keyboard port or mouse port when the corresponding port has the focus.</li> </ul> <p><b>CAC LEDs (Upper row, Green LEDs, CAC models only)</b></p> <ul style="list-style-type: none"> <li><input type="checkbox"/> Online – Lights dim green to indicate that the computer attached to its corresponding port has a USB CAC reader cable connection and the CAC function is enabled.</li> <li><input type="checkbox"/> Selected – Lights bright green to indicate that the CAC function is enabled and the computer attached to its corresponding port has the CAC focus.</li> <li><input type="checkbox"/> None – No lights indicate that the cable is not connected or CAC has been disabled.</li> <li><input type="checkbox"/> Warning - Flashes to indicate that a non-qualified USB smart card / CAC reader is connected when the corresponding port has the focus.</li> </ul> <p><b>Note:</b></p> <ol style="list-style-type: none"> <li>1. CAC function of each port can be enabled or disabled by pressing the port selection pushbutton for more than 3 seconds (this is a toggle feature). Please refer to the Operation section of this user manual for more information.</li> <li>2. All front panel LEDs (except the Power LED) will flash continuously when a chassis intrusion or self-test failure (except for Pushbutton jam) is detected. See Chassis Intrusion Detection section for further details.</li> <li>3. Port and CAC LEDs also indicate the status of the Secure KVM self-test status. See Operation section for further details</li> </ol>
3	Reset Button	<p>Press this button to reset the ATEN Secure KVM Switch.</p> <p><b>Note:</b></p> <p>When you perform a reset by pressing the reset button for more than 5 seconds, the keyboard/mouse buffer will be purged and the switch will reboot and perform a self-test. After a successful self-test, port focus will be switched to port 1, and the CAC function of each port will be set</p>

		<p>to factory default setting (enabled).</p> <p>If the Secure KVM fails to generate video on the monitor after a reset, please power off the installation, check the cables, and follow the instructions found in this manual to power on the installation.</p>
4	Audio Ports	<p>The cables from your speakers plug in here.</p> <p><b>Note:</b> Only standard analogue speaker connections are allowed. The use of an analogue microphone or line-in audio device is strictly prohibited.</p>
5	USB Smart Card / CAC Reader Port (CAC models only)	<p>Only qualified USB authentication devices (e.g., standard smart card and CAC reader) can be plugged into this port.</p> <p><b>Note:</b> USB authentication device filter is configurable by authorized administrators for trusted devices (e.g. USB token, USB Biometric reader). Please refer to the Administrator Guide for details.</p>
6	Num Lock LED	<p>Lights green to indicate the Num Lock function has been turned on.</p> <p><b>Note:</b> The Num Lock LED on the keyboard will be disabled due to security requirements.</p>
7	Caps Lock LED	<p>Lights green to indicate the Caps Lock function has been turned on.</p> <p><b>Note:</b> The Caps Lock LED on the keyboard will be disabled due to security requirements.</p>
8	Scroll Lock LED	<p>Lights green to indicate the Scroll Lock function has been turned on.</p> <p><b>Note:</b> The Scroll Lock LED on the keyboard will be disabled due to security requirements.</p>
9	Power LED	<p>Lights green to indicate that the ATEN Secure KVM Switch is powered on.</p>
10	USB Console Ports	<p>The USB keyboard and mouse plug into these ports. The USB console keyboard port (lower port) and mouse port (upper port) support the following – standard USB keyboards/mice, standard USB keyboards/mice via a USB hub, and the HID functions of a composite device.</p> <p><b>Note:</b></p> <ol style="list-style-type: none"> <li>1. The console USB keyboard and mouse ports are interchangeable, meaning you can connect a keyboard to the mouse port and vice versa. However, for optimal operation it is recommended to connect the USB keyboard to the console's USB keyboard port and the USB mouse to the console's USB mouse port. For security purposes, do not attempt to connect a wireless keyboard or mouse to the switch.</li> <li>2. Non-standard keyboards/mice with integrated USB hubs and/or other USB-integrated devices may not be fully supported due to the strict security standards and policy of the ATEN Secure KVM Switch. If supported, only basic (HID) keyboard/mouse operations will function.</li> <li>3. Multimedia keys on the keyboard will not function due to the</li> </ol>

		<p>security policy.</p> <p>4. The Num Lock, Caps Lock, and Scroll Lock LED on keyboards will not function due to the security policy.</p> <p>5. USB HID device filter is configurable by authorized administrators for trusted devices (only the USB console mouse port is applicable for setting specific blocked devices). Please refer to the Administrator Guide for details.</p>
11	Remote Port Selector Port	<p>The cable on the Remote Port Selector plugs in here. (Remote Port Selector is not supplied in the package)</p>
12	Video LED(s)	<p>This LED lights green when the video connection is up and running. The LED flashes when a non-qualified monitor is connected. <b>Note:</b> With the dual-display model, each console video connection has a video LED.</p>
13	Console Monitor Port(s)	<p>The cable from your console monitor plugs in here. <b>Note:</b> The dual-display model has two console monitor ports.</p>
14	KVM Port Section	<p>The custom KVM cables that attach to your computers plug in this section.</p>
15	KVM Audio Port	<p>The audio cable that attaches to your computer plugs in here. <b>Note:</b> Only speaker connections are allowed. The use of an analog microphone or line-in audio device is strictly prohibited.</p>
16	KVM USB Port	<p>The USB cable that attaches to your computer's keyboard / mouse plugs in here.</p>
17	USB Smart Card / CAC (Common Access Card) Reader Port	<p>The USB cable that attaches to your computer's USB Smart Card / CAC reader plugs in here.</p>
18	Power Switch	<p>This is a standard rocker switch that powers the ATEN Secure KVM Switch on and off.</p>
19	Power Socket	<p>The AC power cord plugs in here.</p>

**Front View (of ATEN Remote Port Selector)**

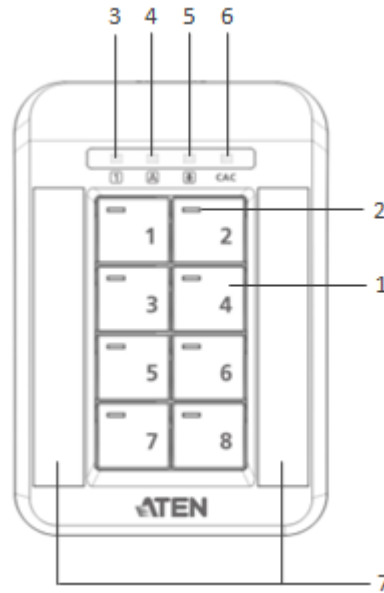

No.	Component	Description
1	Port Selection Pushbuttons	<p>Pressing a Port Selection Pushbutton brings together the keyboard, mouse, video, audio, and CAC reader focus to the computer attached to its corresponding port.</p> <p><b>Note:</b> When attached to a 2-Port Secure KVM Switch, only pushbuttons numbered 1 and 2 will be detected and functional. When attached to a 4-Port Secure KVM Switch, only pushbuttons numbered 1, 2, 3, and 4 will be detected and functional. When attached to an 8-Port Secure KVM Switch, all eight pushbuttons will be detected and functional.</p>
2	Port LEDs	<p>The Port LEDs are located on the upper-left side (of each pushbutton) to indicate Port selection and connection status.</p> <p><b>Port LEDs (Orange LEDs)</b></p> <ul style="list-style-type: none"> <li><input type="checkbox"/> Online – Lights dim orange to indicate that the computer attached to its corresponding port is connected and powered on.</li> <li><input type="checkbox"/> Selected – Lights bright orange to indicate that the computer attached to its corresponding port has the KVM focus.</li> <li><input type="checkbox"/> Warning - Flashes to indicate that a non-qualified USB HID device is connected to console USB keyboard port or mouse port when the corresponding port has the focus.</li> </ul>
3	Num Lock LED	<p>Lights green to indicate the Num Lock function has been turned on.</p> <p><b>Note:</b> The Num Lock LED on the keyboard will be disabled due to security requirements.</p>
4	Caps Lock LED	<p>Lights green to indicate the Caps Lock function has been turned on.</p> <p><b>Note:</b> The Caps Lock LED on the keyboard will be disabled due to</p>

		security requirements.
5	Scroll Lock LED	Lights green to indicate the Scroll Lock function has been turned on. <b>Note:</b> The Scroll Lock LED on the keyboard will be disabled due to security requirements.
6	CAC LED	The CAC LED is located on the far right of the upper bar (on the panel) to indicate CAC reader selection status. <b>CAC LED (Green LED, CAC models only)</b> <input type="checkbox"/> Online/Selected – Lights bright green to indicate that the CAC function is enabled and the computer attached to its corresponding port has a USB CAC reader cable connection, and has the CAC focus. <input type="checkbox"/> None – No lights indicate that the cable is not connected or CAC has been disabled. <input type="checkbox"/> Warning – Flashes to indicate that a non-qualified USB smart card / CAC reader is connected when the corresponding port has the focus. <b>Note:</b> All panel LEDs on the RPS will flash continuously when a chassis intrusion (except for Pushbutton jam) is detected. See Chassis Intrusion Detection section for further details.
7	Port Name Label Area	Port names can be written on labels and placed on these two areas covered with mylar panels for easier port identification.

## Chapter 2

# Hardware Setup

### Before You Begin

#### ATTENTION

If the tamper-evident seal is missing or peeled, avoid using the product and contact your ATEN dealer.

If all front panel LEDs on the Secure KVM Switch (except Power) flash continuously, all Remote Port Selector (RPS) LEDs flash, or either enclosure appears breached, avoid using the product and contact your ATEN dealer.

The Secure KVM Switch and the Remote Port Selector (RPS) are equipped with active always-on chassis intrusion detection security. Any attempt to open the enclosure will permanently disable the switch/ RPS, and void the warranty.



Tamper-evident seal

### Tampering prevention and detection

1. The ATEN Secure KVM Switch and the optional Remote Port Selector (RPS) include tamper-evident tape to provide visual indications of intrusion to the switch/ RPS enclosure. If the tamper-evident seal is missing, peeled, or looks as if it has been adjusted, avoid using the product and contact your ATEN dealer.
2. The ATEN Secure KVM Switch and ATEN RPS are equipped with active always-on chassis intrusion detection:
  - If a mechanical intrusion is detected on the switch, the switch (without RPS connected) will be permanently disabled and all the front panel LEDs (except the Power LED) will flash continuously.
  - If a mechanical intrusion is detected by the RPS (connected with the switch and aligned), this will permanently disable both the RPS itself and the switch, and all LEDs (on RPS) and the front panel LEDs except the Power LED (on switch) will flash continuously.

If the switch or RPS enclosure appears breached or all the LEDs are flashing continuously, stop using it, remove it from service immediately and contact your ATEN dealer.

3. Any attempt to open the switch or RPS enclosure will activate the chassis intrusion detection security, which will render it inoperable and void the warranty.
4. The ATEN Secure KVM Switch cannot be upgraded, serviced or repaired.
5. The ATEN Secure KVM Switch and ATEN RPS contain an internal battery which is non-replaceable. Never attempt to replace the battery or open the switch or RPS enclosure.

### Always use qualified and authorized peripheral devices

1. For security, the ATEN Secure KVM Switch supports only standard USB devices (or pointing device). Do not connect a wireless keyboard/mouse, or any keyboard/mouse with an internal USB



hub or composite device with Non-HID functions to the switch.

2. If a non-qualified keyboard is connected, the keyboard will not function. No keystrokes will be seen on the screen.
3. If a non-qualified mouse is connected, the mouse will not function. No cursor movement will be seen on the screen.
4. For security, the USB console keyboard/mouse ports by default only support the following – standard USB keyboards/mice, standard USB keyboards/mice via a USB hub, and the HID functions of a composite device. Do not connect other USB devices to the USB console keyboard/mouse ports. Non-qualified or non-authorized USB devices will be rejected. For administrative configuration, please refer to the Administrator Guide.
5. Num Lock LED, Caps Lock LED, and Scroll Lock LED on the keyboard will be disabled due to the security policy.
6. Special multimedia keys on the keyboard will be disabled due to the security policy.
7. For security, the ATEN Secure KVM Switch does not support an analogue microphone or line-in audio input. Never connect a microphone or headset microphone to the audio output port. Standard analogue speakers and headsets are supported.
8. For security, the USB CAC port by default only supports authorized user authentication devices such as USB Smartcard or CAC readers. Do not connect other USB devices to the USB CAC port. Non-qualified or non-authorized USB devices will be rejected. For administrative configuration, please refer to the Administrator Guide and Port Authentication Utility Guide for details.
9. For security, do not use any USB CAC authentication device or other peripherals that adopt an external power source.
10. Always use a qualified monitor. Non-qualified monitors will be rejected.
11. Do not use wireless video transmitters or any docking device.
12. Do not connect any Thunderbolt device to the Secure KVM Switch.
13. Any cable connector or non-ATEN remote controller plugged into the console RPS port will be ignored.

## Secure Installation

1. Do not attempt to connect or install the following devices to the computers connected to the ATEN Secure KVM Switch: TEMPEST computers; telecommunication equipment; frame grabber video cards; or special audio processing cards.
2. Important safety information regarding the placement of this device is provided on page 24. Please review it before proceeding.
3. Before installation, make sure the power sources to all devices connected to the installation are turned off. You must unplug the power cords of any computers that have the Keyboard Power On function.
4. Hot-swapping of the console monitor is not allowed. Power off the Secure KVM Switch and the

monitor before changing the console monitor.

5. A computer connected to the Secure KVM Switch should only be powered on after all of the connections to the device are made (video, USB and audio).

## Secure Operation and Administration

Please refer to Administrator Guide for Secure KVM Switch configuration and event log auditing functions.

## *Stacking*

The ATEN Secure KVM Switch features a rugged, metal enclosure which provides stability and allows the unit to be stacked on a desktop. The unit can be placed on any level surface that can safely support its weight and the weight of the attached cables. Ensure that the surface is clean and free of materials that can block the exhaust vents or otherwise interfere with normal operation of the KVM switch.

## *Rack-Mount*

The ATEN Secure KVM Switch features a rack-mount design and offers rack-mount options. Rack-mount kits which are specifically designed to work with this switch are not supplied in the package and require a separate purchase.

## *Installation*

To set up your ATEN Secure KVM Switch installation, refer to the installation diagram on page 18 (the numbers in the diagrams correspond to the steps below), and do the following:

1. Plug your USB keyboard and USB mouse into the USB console ports located on the unit's rear panel. (The console USB keyboard/mouse ports are only compatible with standard USB keyboards/mice).

**Note:**

1. The console USB keyboard and mouse ports are interchangeable, meaning you can connect a keyboard to the mouse port and vice versa. However, for optimal operation, it is recommended to connect the USB keyboard to the console's USB keyboard port and the USB mouse to the console's USB mouse port.
2. For security purposes, do not attempt to connect a wireless keyboard/mouse to the switch.
3. During KVM operation, non-standard keyboards with integrated USB hubs and/or other USB-integrated devices may not be fully supported due to the strict security standards and policy of the ATEN Secure KVM Switch. If supported, only basic (HID) keyboard operations will function.
4. When the Secure KVM Switch is powered on, if the keyboard or mouse is rejected, the keyboard and mouse will be inoperable (mouse cursor freezes and/or no key strokes will respond on the computer).

2. Plug your console monitor(s) into the console video port(s) located on the unit's rear panel and power on the monitor.

**Note:**

1. When the ATEN Secure KVM Switch is powered on, the Video LED lights green when the video connection is up and running. The Video LED flashes when a non-qualified monitor is connected.
2. Due to the security policy, the ATEN Secure KVM Switch does not support a monitor hot-swap. If you would like to change the console monitor, you must first power off the entire installation.
3. Connected monitors will be filtered when the ATEN Secure KVM Switch is powered on. Non-qualified monitors will be rejected (Video LED flashes). Please refer to the LED Display for detailed visual identification.

3. Plug your speakers into the console's speaker jack located on the unit's front panel.

**Note:**

Only speaker connections are allowed. The use of an analogue microphone or line-in audio connection is strictly prohibited.

4. With a single-display Secure KVM Switch, using a KVM cable set (not supplied with this package and must be purchased separately), plug the video connector into any available video socket in the KVM port section of the switch, then plug the accompanying USB (keyboard/mouse or CAC) and speaker connectors into their corresponding USB and speaker ports.

With a dual-display Secure KVM Switch, using a KVM cable set (not supplied with this package and must be purchased separately), plug the video connector for your primary monitor into any available video socket A in the KVM port section of the switch. Using another video cable and plug the video connector for your secondary monitor into video socket B on the same KVM port section of the switch, then plug the accompanying USB (Keyboard/Mouse or CAC) and speaker connectors into their corresponding USB and speaker sockets.

**Note:**

1. Verify that all the plugs are in the same KVM port sockets (all in Port 1, all in Port 2, etc.). Each socket is marked with an appropriate icon.
2. If the CAC reader function is to be disabled for certain PCs, it's advised not to connect a USB CAC cable in the installation.

5. At the other end of the KVM cable set, plug the USB, video, and speaker cables into their respective ports on the computer.

With a dual-display Secure KVM Switch, at the other end of the other video cable, plug this video cable into its respective port on the computer.

**Note:**

1. Verify that the second video plug is in the same KVM port section as the first video plug (all in Port 1, all in Port 2, etc.). Each socket is marked with an appropriate icon.
2. Repeat steps 4, 5 for each computer you are installing.
3. With a dual-display installation, for easier cabling at your site, you can also connect all the primary video connectors to video sockets B, and secondary video connectors to video sockets A. Make sure the console's primary and secondary monitors are connected the same way.

6. Plug the USB Smart Card / CAC reader to the console CAC port on the front panel. (Optional)

**Note:**

1. Only appropriate qualified USB authentication devices (e.g., Smart Card and CAC readers by default) can be plugged into this port. During KVM operation, non-qualified or non-authorized USB devices will be filtered and rejected (the CAC LED that has port focus will flash). Please refer to the LED display for visual indications.
2. The CDF (Configurable Device Filtration) function can only be operated by authorized administrators. Please refer to the Administrator Guide and Port Authentication Utility Guide for details.
3. An active session on the selected computer is immediately terminated upon removal of the CAC card.

7. Plug the cable on the RPS into the console RPS port. (Optional)

**Note:**

1. Be sure to connect the RPS before the ATEN Secure KVM Switch is powered-on.
2. Any connection of RPS after the ATEN Secure KVM Switch is powered-on will not be detected by the switch.

8. Plug the female end of the power cord into the ATEN Secure KVM Switch power socket; plug the male end into an AC power source.

9. Turn on the ATEN Secure KVM Switch and check that the LEDs light up. The ATEN Secure KVM Switch will start a self-test.

**Note:**

The ATEN Secure KVM Switch performs a security self-test at power-on and at each power cycle. Front panel LEDs will indicate the self-test status and test result. Please refer to the Operation section and LED Display section for visual identification details.

## Installation Diagram

### Rear View

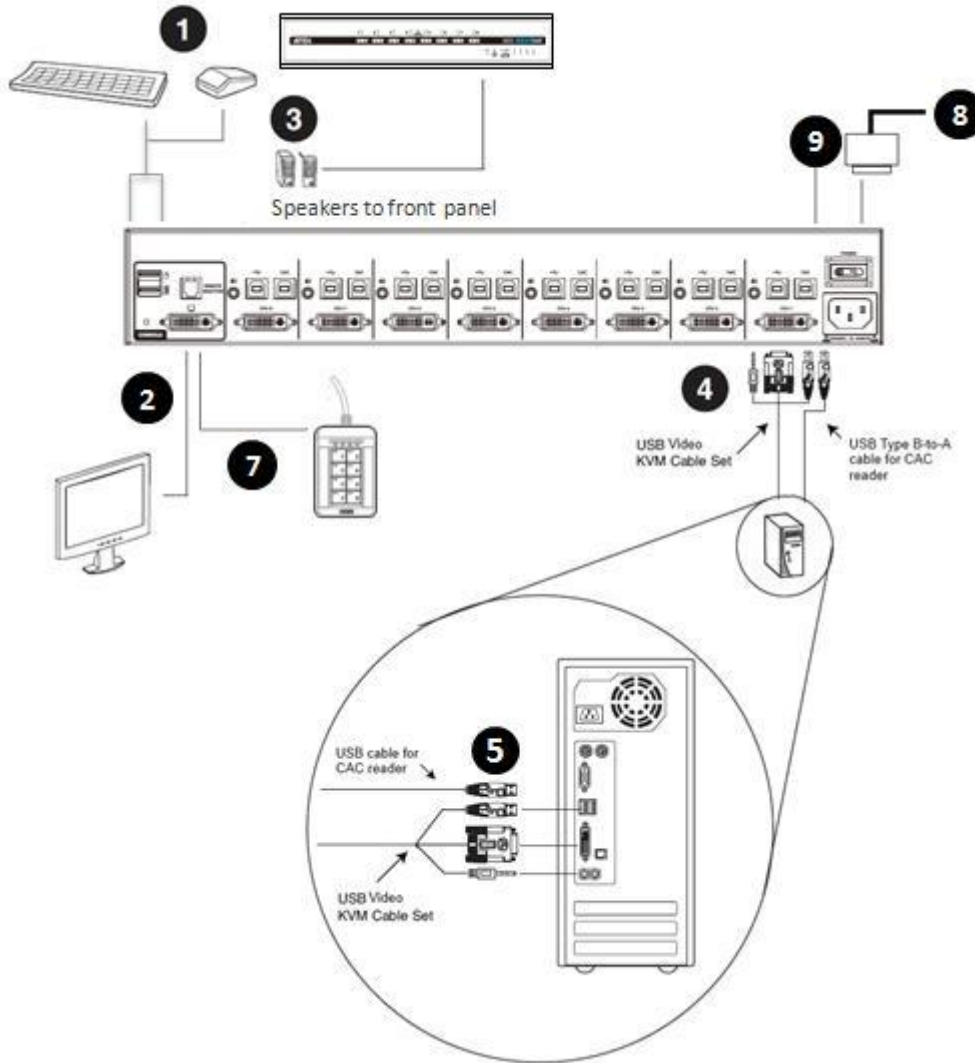

### Front View



## ***Chapter 3***

### ***Operation***

#### ***Powering On***

When you power on, reset, or power cycle the ATEN Secure KVM Switch, the switch will perform a self-test to check the unit's integrity and security functions.

##### **During the self-test**

- All Port LEDs, all CAC LEDs (if supported), Num Lock LED, Caps Lock LED, and Scroll Lock LED on the Secure KVM will turn ON and then OFF.
- The KVM focus will be switched to Port 1 when the self-test completes successfully (Port 1 LED lights bright orange).

##### **Self-test failure**

In the case of a self-test failure, the Secure KVM Switch becomes inoperable, with front panel LED combinations (on the Secure KVM) indicating the potential cause of the failure (such as button jam or KVM integrity compromise)

- A pre-defined combination of the Port and CAC LEDs indicate the cause of the failure.
- If all front panel LEDs on the Secure KVM (except the Power LED) flash continuously, it means KVM tampering is detected or a self-test failure has occurred (except for Pushbutton jam; see below)
- If Pushbutton jam is detected, both the port's LEDs (Port LED and CAC LED) will flash.

For security, the ATEN Secure KVM Switch becomes inoperable if the self-test fails. Please verify your KVM installation by checking that the front panel pushbuttons are not stuck and then power cycle the Secure KVM Switch. If the self-test failure remains, stop using the ATEN Secure KVM Switch immediately, remove it from service and contact your ATEN dealer.

After the ATEN Secure KVM Switch is powered on and ready, power on your computers. By default the ATEN Secure KVM Switch will switch to Port 1 after a successful self-test.

The ATEN Secure KVM Switch filters and emulates both a mouse and keyboard on each port after the unit is powered on. If the keyboard, mouse, monitor, or Smart card / CAC reader fails to operate properly, make sure that you are using the appropriate peripherals (qualified and authorized peripherals); then power off the ATEN Secure KVM Switch, check all the cable connections, and power on the unit again.

## ***Manual Switching***

For increased security, the ATEN Secure KVM Switch offers manual port switching only. This is achieved by pressing the port selection pushbuttons located on the switch front panel or pressing the port selection pushbuttons located on the RPS' panel (if RPS is connected and aligned)

Press and release a port selection pushbutton to bring the KVM focus to the computer attached to its corresponding port (see Port ID Numbering, below). To meet maximum security and channel isolation requirements, the keyboard, mouse, video, audio, and USB CAC reader ports will be switched together. The Selected Port LED lights bright orange (on Switch and/or RPS) to indicate that the computer attached to its corresponding port has the KVM focus (keyboard, mouse, monitor, audio, and CAC reader).

The PC that has the port focus should be able to detect the peripherals after port switching.

If the PC fails to detect the keyboard, mouse, or CAC reader:

- Verify that the keyboard, mouse, and/or CAC reader is qualified.
- Verify that the keyboard, mouse, or CAC reader hasn't failed.
- For USB CAC reader (USB authentication device), please make sure that the USB CAC cable has been securely connected, and the CAC function is enabled.
- For USB CAC reader port, please contact your administrator to verify if the device has been authorized.

## ***Port ID Numbering***

Each KVM port on the ATEN Secure KVM Switch is assigned a port number (1–2 for the 2-Port models; 1–4 for the 4-Port models; 1–8 for the 8-Port models). The port numbers are marked on the rear of the switch. See *Rear View*, page 7. The port ID of a computer is derived from the KVM port number it is connected to.

## ***LED Display***

In addition to the Power LED, the ATEN Secure KVM Switch (and ATEN RPS) has Port LEDs (Online and Selected), keyboard lock (Num Lock/Caps Lock/Scroll Lock) LEDs and CAC LEDs that are built into the front panel to indicate port / keyboard / CAC reader operating status. A video LED is located on the back panel (of the switch) to indicate the operating status of the video connection. These LEDs also serve as the alarm notification for KVM security issues.

LED	Indication
Power LED (on the Secure KVM switch)	The Power LED is on the front panel and lights green to indicate that the KVM switch is powered on.
Video LED (on the Secure KVM switch)	<p>The Video LED is located on the back panel next to each video connector.</p> <ul style="list-style-type: none"> <li><input type="checkbox"/> The LED lights green when the video connection is up and running.</li> <li><input type="checkbox"/> The LED flashes when a non-qualified monitor is connected.</li> </ul>
Port LED (on the Secure KVM switch and the RPS)	<p>The Port LEDs are located on the front panel (of the switch) and the upper-left side of each pushbutton (of the RPS) to indicate the port selection or connection status.</p> <ul style="list-style-type: none"> <li><input type="checkbox"/> Online – Lights dim orange to indicate that the computer attached to its corresponding port connected and powered on.</li> <li><input type="checkbox"/> Selected – Lights bright orange to indicate that the computer attached to its corresponding port has the KVM focus.</li> <li><input type="checkbox"/> Warning - Flashes to indicate that a non-qualified USB HID device is connected to console USB keyboard port or mouse port when the corresponding port has the focus.</li> </ul> <p><b>Note:</b></p> <ol style="list-style-type: none"> <li>1. Port and CAC LEDs will flash constantly when a chassis intrusion is detected. See Chassis Intrusion Detection section for details.</li> <li>2. Port and CAC LEDs (on the Secure KVM switch) also indicate the status of the Secure KVM self-test status. See Operation section for further details.</li> </ol>
CAC LED (on the Secure KVM switch and the RPS) CAC models only	<p>The CAC LEDs are located on the front panel (of the switch) and the far right of the upper bar on the panel (of the RPS) to indicate CAC reader selection or connection status.</p> <ul style="list-style-type: none"> <li><input type="checkbox"/> Online – Lights dim green to indicate that the computer attached to its corresponding port has a USB CAC reader cable connection and the CAC function is enabled.</li> <li><input type="checkbox"/> Selected – Lights bright green to indicate that the CAC function is enabled and the computer attached to its corresponding port has the CAC focus.</li> <li><input type="checkbox"/> None – No lights indicate that the cable is not connected or CAC has been disabled.</li> <li><input type="checkbox"/> Warning - Flashes to indicate that a non-qualified USB Smart card / CAC reader is connected when the corresponding port has the focus.</li> </ul> <p><b>Note:</b></p> <ul style="list-style-type: none"> <li>- The CAC function of each port can be enabled or disabled by</li> </ul>



	<p>pressing the port selection button (on the switch) for more than 3 seconds (this is a toggle feature). Please refer to Operation section for details.</p> <p>- Port and CAC LEDs will flash constantly when a chassis intrusion is detected. See Chassis Intrusion Detection section for further details.</p>
<p>Num Lock LED (on the Secure KVM switch and the RPS)</p>	<p>Lights green to indicate the Num Lock is enabled</p>
<p>Caps Lock LED (on the Secure KVM switch and the RPS)</p>	<p>Lights green to indicate the Caps Lock is enabled</p>
<p>Scroll Lock LED (on the Secure KVM switch and the RPS)</p>	<p>Lights green to indicate the Scroll Lock is enabled</p>

### ***Chassis Intrusion Detection***

To help prevent malicious tampering with the ATEN Secure KVM Switch, the switch (or the RPS) becomes inoperable and all front panel LEDs on the Secure KVM switch (except Power) or all Remote Port Selector (RPS) LEDs flash constantly when a chassis intrusion (such as the cover being removed) is detected (by the switch or by the RPS).

The intrusion detection protection is an always-on function. If all front panel LEDs on the Secure KVM Switch (except Power) flash continuously, all Remote Port Selector (RPS) LEDs flash, or either enclosure appears breached, avoid using the product and contact your ATEN dealer.

### ***Smart Card and CAC Reader (CAC models only)***

The USB Smart Card / CAC reader function of each port can be enabled or disabled (enabled by default). Press the port selection pushbutton (on the switch) for more than 3 seconds then release it, to enable/disable the CAC reader function for that port (this is a toggle feature). The CAC LEDs are used to indicate the CAC reader operation status.

If the CAC reader function is to be disabled for certain PCs, it's advised not to connect a USB CAC cable to the installation.

## ***Appendix***

### ***Safety Instructions***

#### ***General***

- This product is for indoor use only.
- Read all of these instructions. Save them for future reference.
- Follow all warnings and instructions marked on the device.
- Do not place the device on any unstable surface (cart, stand, table, etc.). If the device falls, serious damage will result.
- Do not use the device near water.
- Do not place the device near, or over, radiators or heat registers.
- The device cabinet is provided with slots and openings to allow for adequate ventilation\*. To ensure reliable operation, and to protect against overheating, the cabinet must never be blocked or covered.
- The device should never be placed on a soft surface (bed, sofa, rug, etc.) as this will block its ventilation openings\*. Placing devices without slots or openings on a soft surface will affect the heat dissipation.
- The device should not be placed in a built in enclosure unless adequate ventilation has been provided.
- Never spill liquid of any kind on the device.
- Unplug the device from the wall outlet before cleaning. Do not use liquid or aerosol cleaners. Use a damp cloth for cleaning.
- The device should be operated from the type of power source indicated on the marking label. If you are not sure of the type of power available, consult your dealer or local power company.
- The device is designed for IT power distribution systems with 230V phase-to-phase voltage.
- To prevent damage to your installation it is important that all devices are properly grounded.
- The device is equipped with a 3-wire grounding type plug. This is a safety feature. If you are unable to insert the plug into the outlet, contact your electrician to replace your obsolete outlet. Do not attempt to defeat the purpose of the grounding-type plug. Always follow your local/national wiring codes.
- Do not allow anything to rest on the power cord or cables. Route the power cord and cables so that they cannot be stepped on or tripped over.
- If an extension cord is used with this device make sure that the total of the ampere ratings of all products used on this cord does not exceed the extension cord ampere rating. Make sure that the total of all products plugged into the wall outlet does not exceed 15 amperes.
- To help protect your system from sudden, transient increases and decreases in electrical power, use a surge suppressor, line conditioner, or uninterruptible power supply (UPS).
- Position system cables and power cables carefully; Be sure that nothing rests on any cables.
- Never push objects of any kind into or through cabinet slots. They may touch dangerous voltage

points or short out parts resulting in a risk of fire or electrical shock.

- Do not attempt to service the device yourself. Refer all servicing to qualified service personnel.
- If the following conditions occur, unplug the device from the wall outlet and bring it to qualified service personnel for repair.
  - The power cord or plug has become damaged or frayed.
  - Liquid has been spilled into the device.
  - The device has been exposed to rain or water.
  - The device has been dropped, or the cabinet has been damaged.
  - The device exhibits a distinct change in performance, indicating a need for service.
  - The device does not operate normally when the operating instructions are followed.
- Suitable for installation in Information Technology Rooms in accordance with Article 645 of the National Electrical Code and NFPA 75.

CAUTION: Never attempt to replace battery or open the switch's enclosure.

\*Note: Not all devices have slots or openings to allow for ventilation

## ***Consignes de Sécurité***

### ***Général***

- Ce produit est destiné exclusivement à une utilisation à l'intérieur.
- Veuillez lire la totalité de ces instructions. Conservez-les afin de pouvoir vous y référer ultérieurement.
- Respectez l'ensemble des avertissements et instructions inscrits sur l'appareil.
- Ne placez jamais l'unité sur une surface instable (chariot, pied, table, etc.). Si l'unité venait à tomber, elle serait gravement endommagée.
- N'utilisez pas l'unité à proximité de l'eau.
- Ne placez pas l'unité à proximité de ou sur des radiateurs ou bouches de chaleur.
- Le boîtier de l'unité est destiné à assurer une ventilation adéquate\*. Pour garantir un fonctionnement fiable et protéger l'unité contre les surchauffes, le boîtier de l'unité ne doit jamais être obstrué ou couvert.
- L'unité ne doit jamais être placée sur une surface molle (lit, canapé, tapis, etc.) car ceci obstruerait les ouvertures de ventilation\*. Le fait de placer des appareils sans fente ni ouverture sur une surface souple affecte la dissipation thermique.
- L'appareil ne doit pas être placé dans une enceinte intégrée à moins de lui fournir une ventilation adéquate.
- Ne renversez jamais de liquides de quelque sorte que ce soit sur l'unité.
- Débranchez l'appareil de la prise secteur avant nettoyage. Ne pas utiliser de nettoyant liquide ou en aérosol. Utiliser un chiffon humidifié pour le nettoyage.
- L'appareil doit être alimenté par le type de source indiqué sur l'étiquette. Si vous n'êtes pas sûr du type d'alimentation disponible, consultez votre revendeur ou le fournisseur local d'électricité.
- L'appareil est conçu pour les systèmes de distribution d'alimentation informatique avec une tension phase à phase de 230V
- Afin de ne pas endommager votre installation, vérifiez que tous les périphériques sont correctement mis à la terre.
- L'unité est équipée d'une fiche de terre à trois fils. Il s'agit d'une fonction de sécurité. Si vous ne parvenez pas à insérer la fiche dans la prise murale, contactez votre électricien afin qu'il remplace cette dernière qui doit être obsolète. Respectez toujours les codes de câblage en vigueur dans votre région/pays.
- Veuillez à ce que rien ne repose sur le cordon d'alimentation ou les câbles. Acheminez le cordon d'alimentation et les câbles de sorte que personne ne puisse marcher ou trébucher dessus.
- En cas d'utilisation d'une rallonge avec cette unité, assurez-vous que le total des ampérages de tous les produits utilisés sur cette rallonge ne dépasse pas l'ampérage nominal de cette dernière. Assurez-vous que le total des ampérages de tous les produits branchés sur la prise murale ne dépasse

pas 15 Ampères.

- Pour contribuer à protéger votre système contre les augmentations et diminutions soudaines et transitoires de puissance électrique, utilisez un parasurtenseur, un filtre de ligne ou un système d'alimentation sans coupure (UPS).
- Placez les câbles du système et les câbles d'alimentation avec précaution ; veillez à ce que rien ne repose sur aucun des câbles.
- N'insérez jamais d'objets de quelque sorte que ce soit dans ou à travers les fentes du boîtier. Ils pourraient entrer en contact avec des points de tension dangereuse ou court-circuiter des pièces, entraînant ainsi un risque d'incendie ou de choc électrique.
- N'essayez pas de réparer l'unité vous-même. Confiez toute opération de réparation à du personnel qualifié.
- Si les conditions suivantes se produisent, débranchez l'unité de la prise murale et amenez-la à un technicien qualifié pour la faire réparer:
  - Le cordon d'alimentation ou la fiche ont été endommagés ou éraillés.
  - Du liquide a été renversé dans l'unité.
  - L'unité a été exposée à la pluie ou à l'eau.
  - L'unité est tombée ou le boîtier a été endommagé.
  - Les performances de l'unité sont visiblement altérées, ce qui indique la nécessité d'une réparation.
  - L'unité ne fonctionne pas normalement bien que les instructions d'utilisation soient respectées.
  - Peut être installé dans des salles de matériel de traitement de l'information conformément à l'article 645 du National Electrical Code et à la NFPA 75.

**ATTENTION :** Ne jamais tenter de remplacer la batterie interne ni d'ouvrir le boîtier du commutateur.

\*Remarque : Tous les appareils ne disposent pas de fentes ou d'ouvertures qui permettent la ventilation.

## **Technical Support**

### **International**

- For online technical support – including troubleshooting and documentation:  
<http://eservice.aten.com>
- For telephone support, See *Telephone Support*, page iv:

### **North America**

Email Support		support@aten-usa.com
Online Technical Support	Troubleshooting Documentation Software Updates	<a href="https://eservice.aten.com/eServiceCx/supportIndex.do?lang=en_US">https://eservice.aten.com/eServiceCx/supportIndex.do?lang=en_US</a>
Telephone Support		1-888-999-ATEN ext 4988

When you contact us, please have the following information ready beforehand:

- Product model number, serial number, and date of purchase.
- Your computer configuration, including operating system, revision level, expansion cards, and software.
- Any error messages displayed at the time the error occurred.
- The sequence of operations that led up to the error.
- Any other information you feel may be of help.

## Specifications

**ATEN Single Display DisplayPort Secure KVM (CAC and Non-CAC models)**

Function		CS1182DP4C	CS1184DP4C	CS1188DP4C	CS1182DP4	CS1184DP4	CS1188DP4	
Computer Connections	Direct	2	4	8	2	4	8	
	Max.	2	4	8	2	4	8	
Console Connections		1 Direct			1 Direct			
Port Selection		Pushbutton, Remote Port Selector			Pushbutton, Remote Port Selector			
Connectors	Console Ports	Keyboard	1 x USB Type A Female			1 x USB Type A Female		
		Video	1 x DisplayPort Female (Black)			1 x DisplayPort Female (Black)		
		Mouse	1 x USB Type A Female			1 x USB Type A Female		
		Speaker	1 x Mini Stereo Jack Female (Green)			1 x Mini Stereo Jack Female (Green)		
		Microphone	N/A			NA		
		CAC	1 x USB Type A Female			NA		
	KVM Ports	Keyboard/ Mouse	2 x USB-B Female	4 x USB-B Female	8 x USB-B Female	2 x USB-B Female	4 x USB-B Female	8 x USB-B Female
		Video	2 x DP Female	4 x DP Female	8 x DP Female	2 x DP Female	4 x DP Female	8 x DP Female
		CAC	2 x USB-B Female	4 x USB-B Female	8 x USB-B Female	NA		
		Speaker	2 x Mini Stereo Jack Female	4 x Mini Stereo Jack Female	8 x Mini Stereo Jack Female	2 x Mini Stereo Jack Female	4 x Mini Stereo Jack Female	8 x Mini Stereo Jack Female
		Microphone	N/A			NA		
	Power		1 x 3-prong AC Socket			1 x 3-prong AC Socket		
	Remote Port Selector		1 x RJ-11			1 x RJ-11		
Switches	Port	2 x Pushbuttons	4 x Pushbuttons	8 x Pushbuttons	2 x Pushbuttons	4 x Pushbuttons	8 x Pushbuttons	
	Reset	1 x Semi-recessed Pushbutton			1 x Semi-recessed Pushbutton			
	Power	1 x Rocker			1 x Rocker			
LEDs	On Line / Selected	2 (Orange)	4 (Orange)	8 (Orange)	2 (Orange)	4 (Orange)	8 (Orange)	
	CAC activated	2 (Green)	4 (Green)	8 (Green)	NA			
	Power	1 (Green)			1 (Green)			
	Key Lock LED	3 (Green; Num Lock, Caps Lock, Scroll Lock)			3 (Green; Num Lock, Caps Lock, Scroll Lock)			
	Console Video	1 (Green, on back panel)			1 (Green, on back panel)			
Emulation	Keyboard/Mouse	USB			USB			
Video		Max. 3840 x 2160 @ 30 Hz (UHD)			Max. 3840 x 2160 @ 30 Hz (UHD)			

I/P Rating		100–240V~ ; 50-60 Hz; 1A (TBD)			100–240V~ ; 50-60 Hz; 1A (TBD)		
Environment	Operating Temp.	0–50°C			0–50°C		
	Storage Temp.	-20–60°C			-20–60°C		
	Humidity	0–80% RH, Non-condensing			0–80% RH, Non-condensing		
Physical Properties	Housing	Metal			Metal		
	Weight	1.76kg (TBD)	1.81kg (TBD)	3.30kg (TBD)	1.76kg (TBD)	1.81kg (TBD)	3.30kg (TBD)
	Dimensions	335 x 164 x	335 x 164 x	432 x 205 x	335 x 164 x	335 x 164 x	432 x 205 x
	(L x W x H)	44 mm	44 mm	66 mm	44 mm	44 mm	66 mm

**ATEN Dual Display DisplayPort Secure KVM (CAC and Non-CAC models)**

Function		CS1142DP4C	CS1144DP4C	CS1148DP4C	CS1142DP4	CS1144DP4	CS1148DP4	
Computer Connections	Direct	2	4	8	2	4	8	
	Max.	2	4	8	2	4	8	
Console Connections		1 Direct			1 Direct			
Port Selection		Pushbutton, Remote Port Selector			Pushbutton, Remote Port Selector			
Connectors	Console Ports	Keyboard	1 x USB Type A Female			1 x USB Type A Female		
		Video	2 x DisplayPort Female (Black)			2 x DisplayPort Female (Black)		
		Mouse	1 x USB Type A Female			1 x USB Type A Female		
		Speaker	1 x Mini Stereo Jack Female (Green)			1 x Mini Stereo Jack Female (Green)		
		Microphone	N/A			NA		
		CAC	1 x USB Type A Female			NA		
	KVM Ports	Keyboard/ Mouse	2 x USB-B Female	4 x USB-B Female	8 x USB-B Female	2 x USB-B Female	4 x USB-B Female	8 x USB-B Female
		Video	4 x DP Female	8 x DP Female	16 x DP Female	4 x DP Female	8 x DP Female	16 x DP Female
		CAC	2 x USB-B Female	4 x USB-B Female	8 x USB-B Female	NA		
		Speaker	2 x Mini Stereo Jack Female	4 x Mini Stereo Jack Female	8 x Mini Stereo Jack Female	2 x Mini Stereo Jack Female	4 x Mini Stereo Jack Female	8 x Mini Stereo Jack Female
		Microphone	N/A			NA		
	Power		1 x 3-prong AC Socket			1 x 3-prong AC Socket		
	Remote Port Selector		1 x RJ-11			1 x RJ-11		
	Switches	Port	2 x Pushbuttons	4 x Pushbuttons	8 x Pushbuttons	2 x Pushbuttons	4 x Pushbuttons	8 x Pushbuttons
Reset		1 x Semi-recessed Pushbutton			1 x Semi-recessed Pushbutton			
Power		1 x Rocker			1 x Rocker			
LEDs	On Line / Selected	2 (Orange)	4 (Orange)	8 (Orange)	2 (Orange)	4 (Orange)	8 (Orange)	



	CAC activated	2 (Green)	4 (Green)	8 (Green)	NA			
	Power	1 (Green)			1 (Green)			
	Key Lock LED	3 (Green; Num Lock, Caps Lock, Scroll Lock)			3 (Green; Num Lock, Caps Lock, Scroll Lock)			
	Console Video	2 (Green, on back panel)			2 (Green, on back panel)			
Emulation	Keyboard/Mouse	USB			USB			
Video		Max. 3840 x 2160 @ 30 Hz (UHD)			Max. 3840 x 2160 @ 30 Hz (UHD)			
I/P Rating		100-240V~ ; 50-60 Hz; 1A	100-240V~ ; 50-60 Hz; 1.5A		100-240V~ ; 50-60 Hz; 1A (TBD)	100-240V~ ; 50-60 Hz; 1.5A		
Environment		Operating Temp.	0-50°C			0-50°C		
		Storage Temp.	-20-60°C			-20-60°C		
		Humidity	0-80% RH, Non-condensing			0-80% RH, Non-condensing		
Physical Properties		Housing	Metal			Metal		
		Weight	2.13kg (TBD)	2.18kg (TBD)	3.22kg (TBD)	2.13kg (TBD)	2.18kg (TBD)	3.22kg (TBD)
		Dimensions	335 x 164 x	335 x 164 x	432 x 205 x	335 x 164 x	335 x 164 x	432 x 205 x
		(L x W x H)	66 mm	66 mm	66 mm	66 mm	66 mm	66 mm

**ATEN Single Display HDMI Secure KVM (CAC and Non-CAC models)**

Function		CS1182H4C	CS1184H4C	CS1182H4	CS1184H4	
Computer Connections	Direct	2	4	2	4	
	Max.	2	4	2	4	
Console Connections		1 Direct		1 Direct		
Port Selection		Pushbutton, Remote Port Selector		Pushbutton, Remote Port Selector		
Connectors	Console Ports	Keyboard	1 x USB Type A Female		1 x USB Type A Female	
		Video	1 x HDMI Female (Black)		1 x HDMI Female (Black)	
		Mouse	1 x USB Type A Female		1 x USB Type A Female	
		Speaker	1 x Mini Stereo Jack Female (Green)		1 x Mini Stereo Jack Female (Green)	
		Microphone	N/A		NA	
		CAC	1 x USB Type A Female		NA	
	KVM Ports	Keyboard/ Mouse	2 x USB-B Female	4 x USB-B Female	2 x USB-B Female	4 x USB-B Female
		Video	2 x HDMI Female	4 x HDMI Female	2 x HDMI Female	4 x HDMI Female
		CAC	2 x USB-B Female	4 x USB-B Female	NA	
		Speaker	2 x Mini Stereo Jack Female	4 x Mini Stereo Jack Female	2 x Mini Stereo Jack Female	4 x Mini Stereo Jack Female
		Microphone	N/A		NA	

	Power	1 x 3-prong AC Socket		1 x 3-prong AC Socket	
	Remote Port Selector	1 x RJ-11		1 x RJ-11	
Switches	Port	2 x Pushbuttons	4 x Pushbuttons	2 x Pushbuttons	4 x Pushbuttons
	Reset	1 x Semi-recessed Pushbutton		1 x Semi-recessed Pushbutton	
	Power	1 x Rocker		1 x Rocker	
LEDs	On Line / Selected	2 (Orange)	4 (Orange)	2 (Orange)	4 (Orange)
	CAC activated	2 (Green)	4 (Green)	NA	
	Power	1 (Green)		1 (Green)	
	Key Lock LED	3 (Green; Num Lock, Caps Lock, Scroll Lock)		3 (Green; Num Lock, Caps Lock, Scroll Lock)	
	Console Video	1 (Green, on back panel)		1 (Green, on back panel)	
Emulation	Keyboard/Mouse	USB		USB	
Video		Max. 3840 x 2160 @ 60 Hz (UHD)		Max. 3840 x 2160 @ 60 Hz (UHD)	
I/P Rating		100-240V~ ; 50-60 Hz; 1A (TBD)		100-240V~ ; 50-60 Hz; 1A (TBD)	
Environment	Operating Temp.	0-50°C		0-50°C	
	Storage Temp.	-20-60°C		-20-60°C	
	Humidity	0-80% RH, Non-condensing		0-80% RH, Non-condensing	
Physical Properties	Housing	Metal		Metal	
	Weight	1.76kg (TBD)	1.76kg (TBD)	1.76kg (TBD)	1.76kg (TBD)
	Dimensions (L x W x H)	335 x 164 x 44 mm	335 x 164 x 44 mm	335 x 164 x 44 mm	335 x 164 x 44 mm

**ATEN Dual Display HDMI Secure KVM (CAC and Non-CAC models)**

Function		CS1142H4C	CS1144H4C	CS1142H4	CS1144H4	
Computer Connections	Direct	2	4	2	4	
	Max.	2	4	2	4	
Console Connections		1 Direct		1 Direct		
Port Selection		Pushbutton, Remote Port Selector		Pushbutton, Remote Port Selector		
Connectors	Console Ports	Keyboard	1 x USB Type A Female		1 x USB Type A Female	
		Video	2 x HDMI Female (Black)		2 x HDMI Female (Black)	
		Mouse	1 x USB Type A Female		1 x USB Type A Female	
		Speaker	1 x Mini Stereo Jack Female (Green)		1 x Mini Stereo Jack Female (Green)	
		Microphone	N/A		NA	
		CAC	1 x USB Type A Female		NA	
	KVM Ports	Keyboard/ Mouse	2 x USB-B Female	4 x USB-B Female	2 x USB-B Female	4 x USB-B Female
		Video	4 x HDMI Female	8 x HDMI Female	4 x HDMI Female	8 x HDMI Female

	CAC	2 x USB-B Female	4 x USB-B Female	NA	
	Speaker	2 x Mini Stereo Jack Female	4 x Mini Stereo Jack Female	2 x Mini Stereo Jack Female	4 x Mini Stereo Jack Female
	Microphone	N/A		NA	
	Power	1 x 3-prong AC Socket		1 x 3-prong AC Socket	
	Remote Port Selector	1 x RJ-11		1 x RJ-11	
Switches	Port	2 x Pushbuttons	4 x Pushbuttons	2 x Pushbuttons	4 x Pushbuttons
	Reset	1 x Semi-recessed Pushbutton		1 x Semi-recessed Pushbutton	
	Power	1 x Rocker		1 x Rocker	
LEDs	On Line / Selected	2 (Orange)	4 (Orange)	2 (Orange)	4 (Orange)
	CAC activated	2 (Green)	4 (Green)	NA	
	Power	1 (Green)		1 (Green)	
	Key Lock LED	3 (Green; Num Lock, Caps Lock, Scroll Lock)		3 (Green; Num Lock, Caps Lock, Scroll Lock)	
	Console Video	2 (Green, on back panel)		2 (Green, on back panel)	
Emulation	Keyboard/Mouse	USB		USB	
Video		Max. 3840 x 2160 @ 60 Hz (UHD)		Max. 3840 x 2160 @ 60 Hz (UHD)	
I/P Rating		100–240V~ ; 50-60 Hz; 1A (TBD)		100–240V~ ; 50-60 Hz; 1A (TBD)	
Environment	Operating Temp.	0–50°C		0–50°C	
	Storage Temp.	-20–60°C		-20–60°C	
	Humidity	0–80% RH, Non-condensing		0–80% RH, Non-condensing	
Physical Properties	Housing	Metal		Metal	
	Weight	2.06kg (TBD)	2.11kg (TBD)	2.06kg (TBD)	2.11kg (TBD)
	Dimensions (L x W x H)	335 x 164 x 66 mm	335 x 164 x 66 mm	335 x 164 x 66 mm	335 x 164 x 66 mm

**ATEN Single Display DVI Secure KVM (CAC and Non-CAC models)**

Function		CS1182D4C	CS1184D4C	CS1188D4C	CS1182D4	CS1184D4	CS1188D4
Computer	Direct	2	4	8	2	4	8
Connections	Max.	2	4	8	2	4	8
Console Connections		1 Direct			1 Direct		
Port Selection		Pushbutton, Remote Port Selector			Pushbutton, Remote Port Selector		
Connectors	Console Ports	Keyboard	1 x USB Type A Female		1 x USB Type A Female		
		Video	1 x DVI-I DL Female		1 x DVI-I DL Female		
		Mouse	1 x USB Type A Female		1 x USB Type A Female		
		Speaker	1 x Mini Stereo Jack Female (Green)		1 x Mini Stereo Jack Female (Green)		
		Microphone	N/A		NA		

		CAC	1 x USB Type A Female			NA		
KVM Ports	Keyboard/ Mouse	2 x USB-B Female	4 x USB-B Female	8 x USB-B Female	2 x USB-B Female	4 x USB-B Female	8 x USB-B Female	
	Video	2 x DVI-I DL Female	4 x DVI-I DL Female	8 x DVI-I DL Female	2 x DVI-I DL Female	4 x DVI-I DL Female	8 x DVI-I DL Female	
	CAC	2 x USB-B Female	4 x USB-B Female	8 x USB-B Female	NA			
	Speaker	2 x Mini Stereo Jack Female	4 x Mini Stereo Jack Female	8 x Mini Stereo Jack Female	2 x Mini Stereo Jack Female	4 x Mini Stereo Jack Female	8 x Mini Stereo Jack Female	
	Microphone	N/A			NA			
Power		1 x 3-prong AC Socket			1 x 3-prong AC Socket			
Remote Port Selector		1 x RJ-11			1 x RJ-11			
Switches	Port	2 x Pushbuttons	4 x Pushbuttons	8 x Pushbuttons	2 x Pushbuttons	4 x Pushbuttons	8 x Pushbuttons	
	Reset	1 x Semi-recessed Pushbutton			1 x Semi-recessed Pushbutton			
	Power	1 x Rocker			1 x Rocker			
LEDs	On Line / Selected	2 (Orange)	4 (Orange)	8 (Orange)	2 (Orange)	4 (Orange)	8 (Orange)	
	CAC activated	2 (Green)	4 (Green)	8 (Green)	NA			
	Power	1 (Green)			1 (Green)			
	Key Lock LED	3 (Green; Num Lock, Caps Lock, Scroll Lock)			3 (Green; Num Lock, Caps Lock, Scroll Lock)			
	Console Video	1 (Green, on back panel)			1 (Green, on back panel)			
Emulation	Keyboard/Mouse	USB			USB			
Video		DVI Dual Link: 2560 x 1600*			DVI Dual Link: 2560 x 1600*			
I/P Rating		100–240V~ ; 50-60 Hz; 1A (TBD)			100–240V~ ; 50-60 Hz; 1A (TBD)			
Environment	Operating Temp.	0–50°C			0–50°C			
	Storage Temp.	-20–60°C			-20–60°C			
	Humidity	0–80% RH, Non-condensing			0–80% RH, Non-condensing			
Physical Properties	Housing	Metal			Metal			
	Weight	1.79kg (TBD)	1.80kg (TBD)	3.35kg (TBD)	1.79kg (TBD)	1.80kg (TBD)	3.35kg (TBD)	
	Dimensions	335 x 164 x	335 x 164 x	432 x 205 x	335 x 164 x	335 x 164 x	432 x 205 x	
	(L x W x H)	44 mm	44 mm	66 mm	44 mm	44 mm	66 mm	

\* DVI Secure KVM Switches offer 3840 x 2160 @ 30 Hz video output on compatible HDMI-interfaced monitors/computers with ATEN DVI-to-HDMI KVM cables

**ATEN Dual Display DVI Secure KVM (CAC and Non-CAC models)**

Function		CS1142D4C	CS1144D4C	CS1148D4C	CS1142D4	CS1144D4	CS1148D4
Computer	Direct	2	4	8	2	4	8

Connections	Max.	2	4	8	2	4	8	
Console Connections		1 Direct			1 Direct			
Port Selection		Pushbutton, Remote Port Selector			Pushbutton, Remote Port Selector			
Connectors	Console Ports	Keyboard	1 x USB Type A Female			1 x USB Type A Female		
		Video	2 x DVI-I DL Female			2 x DVI-I DL Female		
		Mouse	1 x USB Type A Female			1 x USB Type A Female		
		Speaker	1 x Mini Stereo Jack Female (Green)			1 x Mini Stereo Jack Female (Green)		
		Microphone	N/A			NA		
		CAC	1 x USB Type A Female			NA		
	KVM Ports	Keyboard/ Mouse	2 x USB-B Female	4 x USB-B Female	8 x USB-B Female	2 x USB-B Female	4 x USB-B Female	8 x USB-B Female
		Video	4 x DVI-I DL Female	8 x DVI-I DL Female	16 x DVI-I DL Female	4 x DVI-I DL Female	8 x DVI-I DL Female	16 x DVI-I DL Female
		CAC	2 x USB-B Female	4 x USB-B Female	8 x USB-B Female	NA		
		Speaker	2 x Mini Stereo Jack Female	4 x Mini Stereo Jack Female	8 x Mini Stereo Jack Female	2 x Mini Stereo Jack Female	4 x Mini Stereo Jack Female	8 x Mini Stereo Jack Female
		Microphone	N/A			NA		
Power	1 x 3-prong AC Socket			1 x 3-prong AC Socket				
Remote Port Selector	1 x RJ-11			1 x RJ-11				
Switches	Port	2 x Pushbuttons	4 x Pushbuttons	8 x Pushbuttons	2 x Pushbuttons	4 x Pushbuttons	8 x Pushbuttons	
	Reset	1 x Semi-recessed Pushbutton			1 x Semi-recessed Pushbutton			
	Power	1 x Rocker			1 x Rocker			
LEDs	On Line / Selected	2 (Orange)	4 (Orange)	8 (Orange)	2 (Orange)	4 (Orange)	8 (Orange)	
	CAC activated	2 (Green)	4 (Green)	8 (Green)	NA			
	Power	1 (Green)			1 (Green)			
	Key Lock LED	3 (Green; Num Lock, Caps Lock, Scroll Lock)			3 (Green; Num Lock, Caps Lock, Scroll Lock)			
	Console Video	2 (Green, on back panel)			2 (Green, on back panel)			
Emulation	Keyboard/Mouse	USB			USB			
Video		DVI Dual Link: 2560 x 1600*			DVI Dual Link: 2560 x 1600*			
I/P Rating		100–240V~ ; 50-60 Hz; 1A	100–240V~ ; 50-60 Hz; 1.5A	100–240V~ ; 50-60 Hz; 1A	100–240V~ ; 50-60 Hz; 1A	100–240V~ ; 50-60 Hz; 1.5A	100–240V~ ; 50-60 Hz; 1A	
Environment	Operating Temp.	0–50°C			0–50°C			
	Storage Temp.	-20–60°C			-20–60°C			
	Humidity	0–80% RH, Non-condensing			0–80% RH, Non-condensing			
Physical Properties	Housing	Metal			Metal			

	Weight	2.14kg (TBD)	2.18kg (TBD)	3.34kg (TBD)	2.14kg (TBD)	2.18kg (TBD)	3.34kg (TBD)
	Dimensions	335 x 164 x	335 x 164 x	432 x 205 x	335 x 164 x	335 x 164 x	432 x 205 x
	(L x W x H)	66 mm	66 mm	66 mm	66 mm	66 mm	66 mm

\* DVI Secure KVM Switches offer 3840 x 2160 @ 30 Hz video output on compatible HDMI-interfaced monitors/computers with ATEN DVI-to-HDMI KVM cables

***Limited Warranty***

IN NO EVENT SHALL THE DIRECT VENDOR'S LIABILITY EXCEED THE PRICE PAID FOR THE PRODUCT FROM DIRECT, INDIRECT, SPECIAL, INCIDENTAL, OR CONSEQUENTIAL DAMAGES RESULTING FROM THE USE OF THE PRODUCT, DISK, OR ITS DOCUMENTATION.

The direct vendor makes no warranty or representation, expressed, implied, or statutory with respect to the contents or use of this documentation, and especially disclaims its quality, performance, merchantability, or fitness for any particular purpose.

The direct vendor also reserves the right to revise or update the device or documentation without obligation to notify any individual or entity of such revisions, or update. For further inquiries, please contact your direct vendor.