

User Manual



RW119 – Series

- 1U widescreen 19" LCD keyboard drawer
- Combo interface PS/2 or USB input
- Keyboard available in 13 international languages
- Resolution up to 1440 x 900
- Full range of KVM options

RWS119 – Series

- 1U widescreen 19" LCD keyboard drawer
- Direct support for SUN Micro 1152 x 900 native resolution
- Combo interface PS/2 or USB input
- SUN key support including Stop, Cut, Paste, Compose etc
- Full range of KVM options



**Raloy LCD Rack Console with Integrated Matrix IP CAT5/6 KVM
16 or 32 Ports**

RW119- Widescreen Series	RW119- MUIP1613 / MUIP1614 / MUIP1624	RW119- MUIP3213 / MUIP3214 / MUIP3224
RWS119- Sun Solaris Series	RWS119- MUIP1613 / MUIP1614 / MUIP1624	RWS119- MUIP3213 / MUIP3214 / MUIP3224

Contents

Chapter 1 Getting Started	1
1.1 Important Safeguards	1
1.2 Regulatory Notice	2
Legal Information	2
Safety Instructions.....	2
Regulatory Notices Federal Communications Commission (FCC)	2
1.3 Package Contents	3
1.4 Before Installation	4
1.5 Unpacking	4
1.6 Optional Accessories	5
1.7 LCD Rackmount Structure Diagram	6
1.8 Installation	7
1.9 Installation (continued)	8
1.10 How to use the slides	9
1.11 How to use the LCD Keyboard Drawer	10
1.12 KVM Model Connection Diagrams	11
1.13 KVM Diagrams	12
Models:	12
RW119-MUIP1613	12
RWS119-MUIP1613	12
RW119-MUIP1614	12
RWS119-MUIP1614	12
RW119-MUIP1624	12
RWS119-MUIP1624	12
KVM Server Connection	12
KVM Cascade.....	12
1.14 KVM Diagrams	2
Models:	2
RW119-MUIP3213 RWS119-MUIP3213	2
RW119-MUIP3214	2
RWS119-MUIP3214	2
RW119-MUIP3224 RWS119-MUIP3224	2
KVM Server Connection	2
KVM Cascade.....	2

1.15	KVM Connection KVM Cable Connection & Receiver Diagrams (All Models)	2
	Receiver	2
	Receiver Connection	2
Chapter 2	Operation	3
2.1	On-screen Display Operation	3
2.2	On-screen Menu	4
Chapter 3	LCD Specifications	5
3.1	LCD Rackmount Widescreen Series Specifications	5
3.2	Keyboard & Mouse	6
	For RW119 series	6
3.2	Keyboard & Mouse (Continued)	7
	For RWS119 series	7
3.3	How to use "NS" keyboard	8
Chapter 4	KVM Specifications	9
4.1	Matrix-Multi-User CAT 5/6 KVM Over IP	9
4.2	DVI-D Option	10
4.3	BNC + S-Video Option	10
4.4	Audio Option	10
4.5	DC Power Options	11
Chapter 5	Troubleshooting	12
	For RWS119 Series	12
Chapter 6	Dimensions	13

Chapter 1 Getting Started

1.1 Important Safeguards

Please read all of these instructions carefully before you use the device. Save this manual for future reference.

What the warranty does not cover

- Any product, on which the serial number has been defaced, modified or removed.
- Damage, deterioration or malfunction resulting from:
 - Accident, misuse, neglect, fire, water, lightning, or other acts of nature, unauthorized product modification, or failure to follow instructions supplied with the product.
 - Repair or attempted repair by anyone not authorized by us.
 - Any damage of the product due to shipment.
 - Removal or installation of the product.
 - Causes external to the product, such as electric power fluctuation or failure.
 - Use of supplies or parts not meeting our specifications.
 - Normal wear and tear.
 - Any other causes which does not relate to a product defect.
- Removal, installation, and set-up service charges.

1.2 Regulatory Notice

Legal Information

First English printing, October 2002

Information in this document has been carefully checked for accuracy; however, no guarantee is given to the correctness of the contents. The information in this document is subject to change without notice. We are not liable for any injury or loss that results from the use of this equipment.

Safety Instructions

- Unplug equipment before cleaning. Don't use liquid or spray detergent; use a moist cloth.
- Keep equipment away from excessive humidity and heat. Preferably, keep it in an air-conditioned environment with temperatures not exceeding 40° Celsius (104° Fahrenheit).
- When installing, place the equipment on a sturdy, level surface to prevent it from accidentally falling and causing damage to other equipment or injury to persons nearby.
- When the drawer is in an open position, do not cover, block or in any way obstruct the gap between it and the power supply. Proper air convection is necessary to keep it from overheating.
- Arrange the equipment's power cord in such a way that others won't trip or fall over it.
- If you are using a power cord that didn't ship with the equipment, ensure that it is rated for the voltage and current labeled on the equipment's electrical ratings label. The voltage rating on the cord should be higher than the one listed on the equipment's ratings label.
- Observe all precautions and warnings attached to the equipment.
- If you don't intend on using the equipment for a long time, disconnect it from the power outlet to prevent being damaged by transient over-voltage.
- Keep all liquids away from the equipment to minimize the risk of accidental spillage. Liquid spilled on to the power supply or on other hardware may cause damage, fire or electrical shock.
- Only qualified service personnel should open the chassis. Opening it yourself could damage the equipment and invalidate its warranty.
- If any part of the equipment becomes damaged or stops functioning, have it checked by qualified service personnel.

CAUTION: Slide/rail mounted equipment is not to be used as a shelf or a work space.



Regulatory Notices Federal Communications Commission (FCC)

This equipment has been tested and found to comply with the limits for a Class B digital device, pursuant to Part 15 of the FCC rules. These limits are designed to provide reasonable protection against harmful interference in a residential installation.

Any changes or modifications made to this equipment may void the user's authority to operate this equipment. This equipment generates, uses, and can radiate radio frequency energy and, if not installed and used in accordance with the instructions, may cause harmful interference to radio communications. However, there is no guarantee that interference will not occur in a particular installation. If this equipment does cause harmful interference to radio or television reception, which can be determined by turning the equipment off and on, the user is encouraged to try to correct the interference by one or more of the following measures:

- Re-position or relocate the receiving antenna.
- Increase the separation between the equipment and receiver.
- Connect the equipment into an outlet on a circuit different from that to which the receiver is connected.

1.3 Package Contents

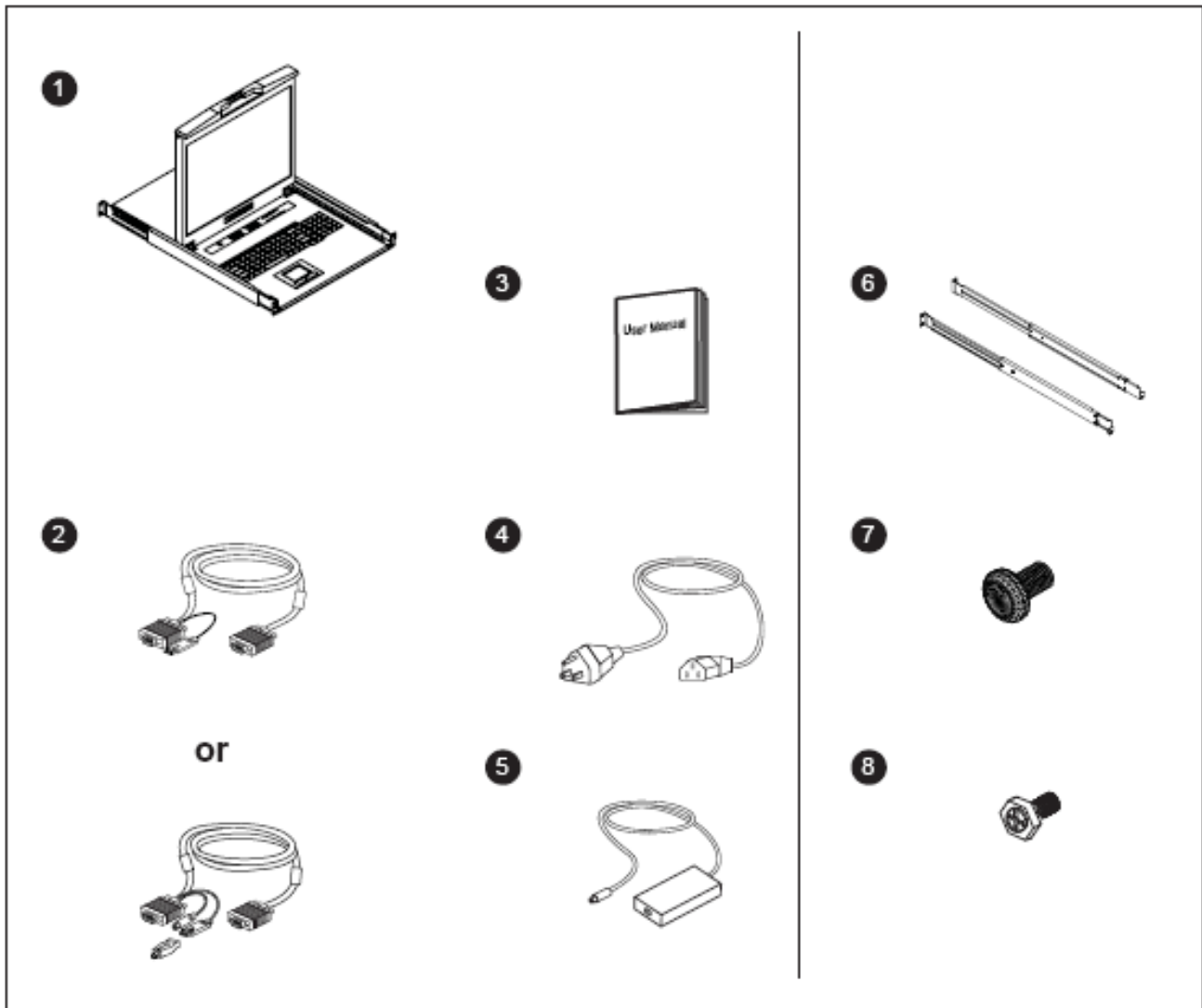

- 1) LCD keyboard drawer w/ integrated KVM Switch x 1 pc
- 2) Screw M3.2 x 4 pcs
- 3) Screw M4 x 10mm x 8pcs
- 4) Bracket x 1 set
- 5) User Manual x 1 pc
- 6) 12V Power Adapter
- 7) Receiver x 1 set (for MUIP1613, MUIP1624, MUIP 3213 & MUIP3224)
Receiver x 2 set (for MUIP 1614 & MUIP 3214)
- 8) **RDG-100S** USB Dongle for CAT5/6 KVM x 16pcs
RCE-6 Combo 4-in-1 KVM cable x 1 pcs (for MUIP1613, MUIP1624, MUIP 3213 & MUIP3224)
RCE-6 Combo 4-in-1 KVM cable x 2 pcs (for MUIP 1614 & MUIP 3214)

1.4 Before Installation

- It is very important to place the LCD Keyboard Drawer in a suitable environment.
- The surface for placing and fixing the LCD Keyboard Drawer should be stable and level or mounted into a suitable cabinet.
- Make sure the location is well ventilated, out of direct sunlight, away from sources of excessive dust, dirt, heat, water, moisture and vibration.
- Position LCD Keyboard Drawer with respect to related facilities.

1.5 Unpacking

The LCD keyboard drawer comes with the standard parts as shown in the package contents. Check and make sure they are included and in good condition. If anything is missing, or damage, contact the supplier immediately.

1.6 Optional Accessories

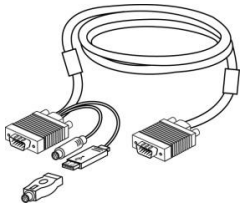
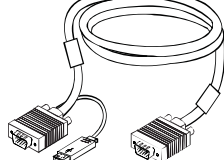
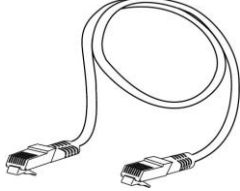
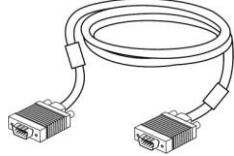
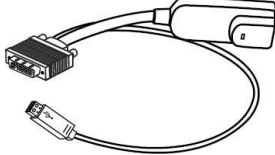
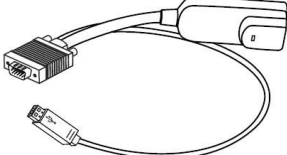
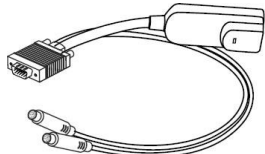
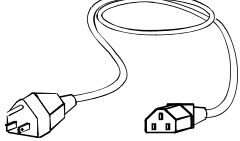
<p>1. Combo 4-in-1 KVM Cable (For RW-Series)</p> <ul style="list-style-type: none"> 1.1 RCE-6 6 feet 1.2 RCE-10 10 feet 1.3 RCE-15 15 feet 	
<p>2. USB 2-in-1 KVM cable (For RWS-Series)</p> <ul style="list-style-type: none"> 2.1 RCB-6 6 feet 2.2 RCB-10 10 feet 2.3 RCB-15 15 feet 	
<p>3. CAT5 cable</p> <ul style="list-style-type: none"> 3.1 RCU-3 3 feet 3.2 RCU-6 6 feet 3.3 RCU-10 10 feet 3.4 RCU-15 15 feet 3.5 RCU-33 33 feet 3.6 RCU-66 66 feet 	
<p>4. Combo KVM cascade cable</p> <ul style="list-style-type: none"> 4.1 RCBC-6 6 feet 	
<p>5. DVI-USB dongle for CAT5/6 KVM</p> <ul style="list-style-type: none"> 5.1 RDG-100SD 	
<p>6. VGA-USB dongle for CAT5/6 KVM</p> <ul style="list-style-type: none"> 6.1RDG-100S 	
<p>7. VGA-PS/2 dongle for CAT5/6 KVM</p> <ul style="list-style-type: none"> 7.1 RDG-100 	
<p>8. Power cord</p> <ul style="list-style-type: none"> 8.1 IEC power cord 8.2 NEMA5-15 power cord 	

1.7 LCD Rackmount Structure Diagram

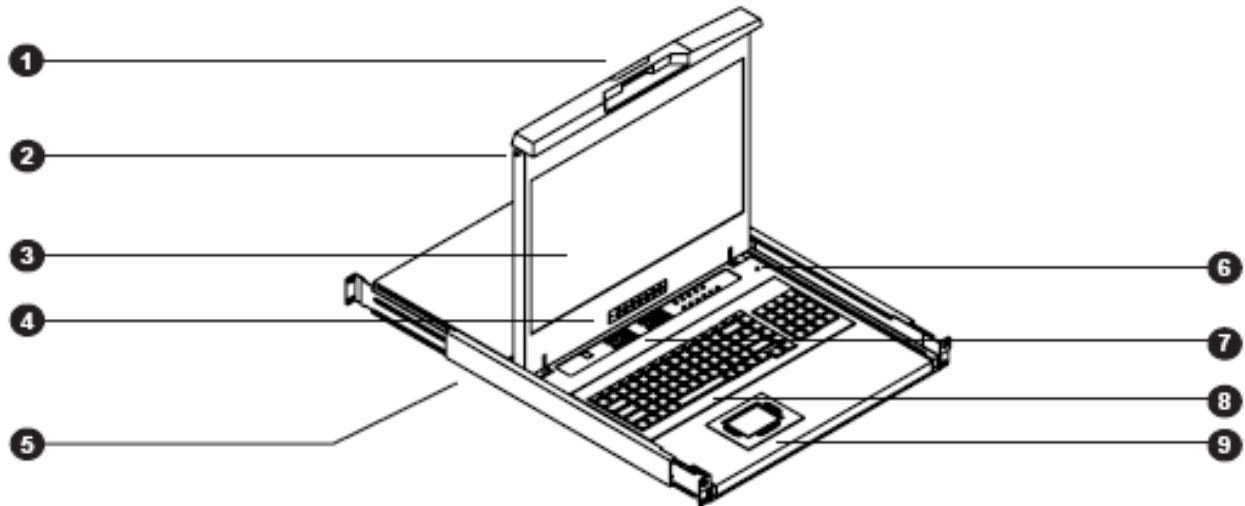

1. Carry handle to release the two-point lock
2. Two-point lock
3. LCD interchangeable module kit
4. LCD membrane
5. "One Man" Installation Slide
6. Micro switch for screen auto power off
7. Keyboard interchangeable module kit
8. Membrane switch (KVM option)
9. Mouse interchangeable module kit

1.8 Installation

1

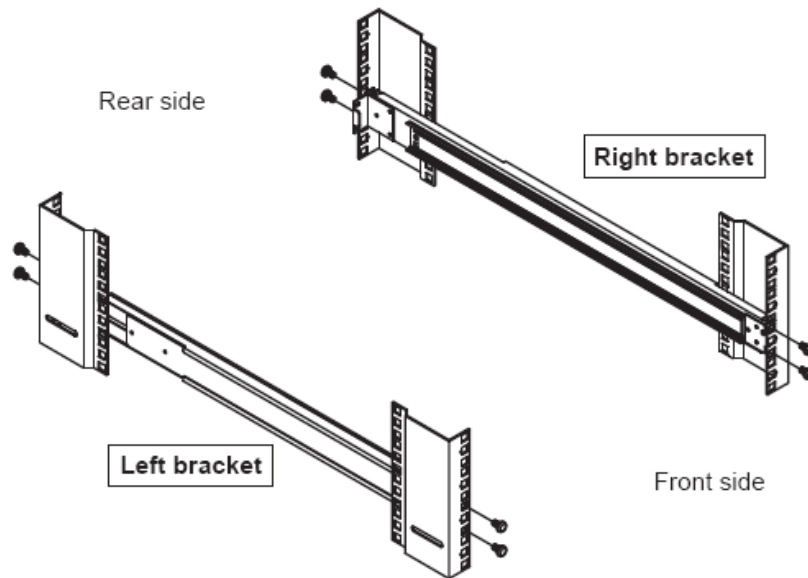

- Attach the **left and right mounting bracket** to rack 19" mounting rails
- Adjust the mounting bracket to fit your rack
- M6 screw x 8pcs included

! **Caution:** Leaving all M6 screw slightly loose, until you complete the installation in step **5**

2

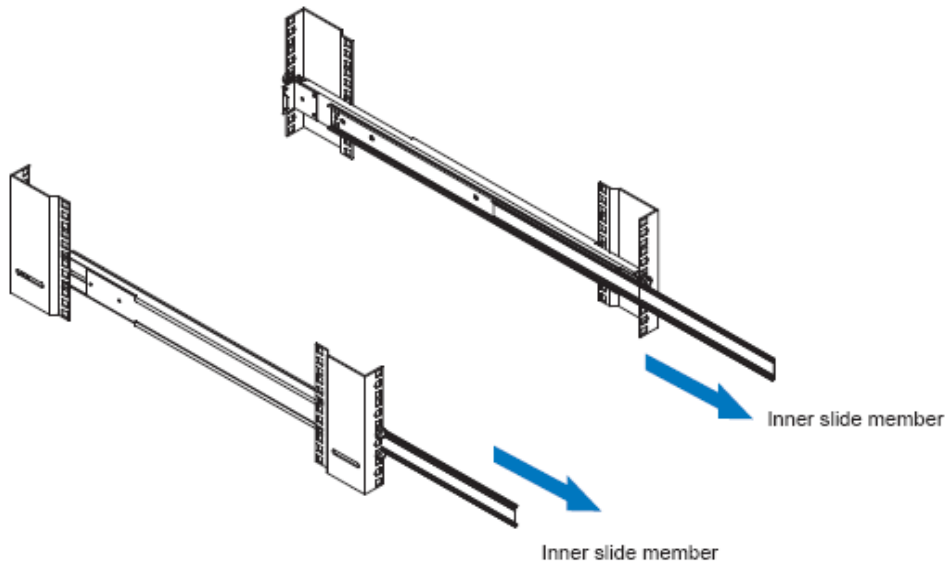

- Pull out left & right inner slide members

1.9 Installation (continued)

3

- Pick up the LCD tray.
- Insert the LCD tray into the mounting bracket.
- Pull and hold the left & right black arrow buttons on the rails. Return the LCD tray to park position.

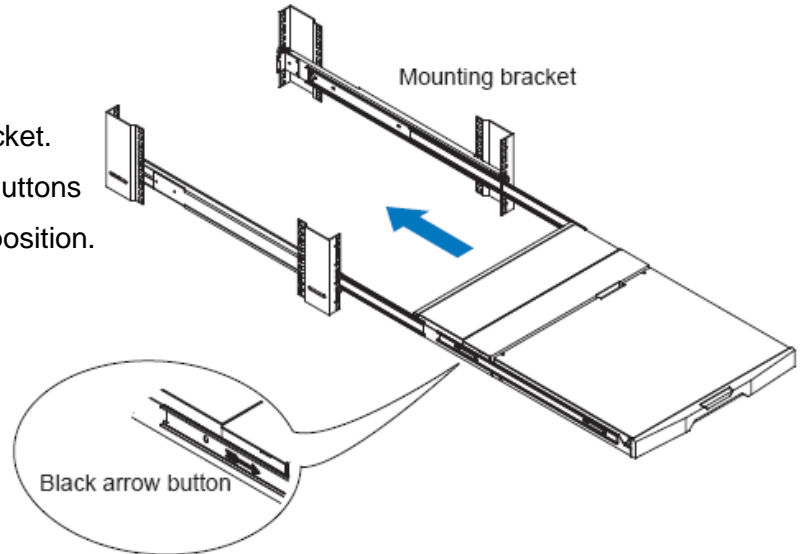

4

- Fix the **rear kit** to the mounting bracket by M3.2 screw x 4 pcs included.

! **Caution:** This step is necessary. Failure to complete this will cause damage.

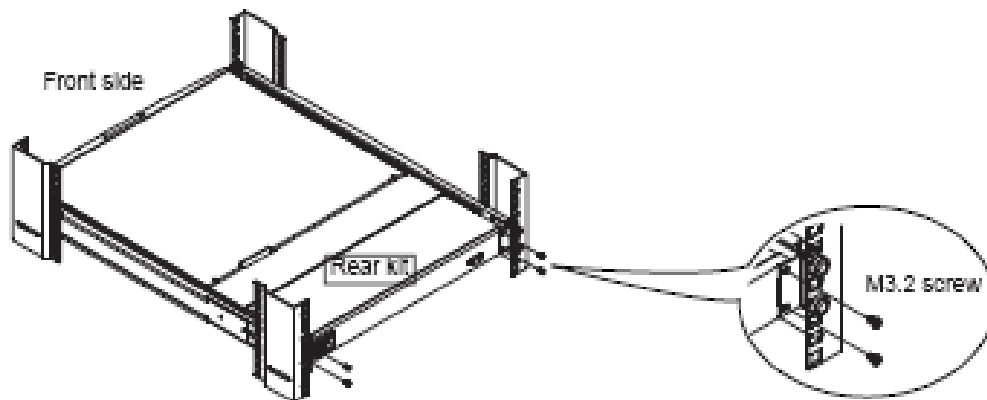

5 Complete the installation

- Tighten all 8 pcs of M6 screw to complete the installation.

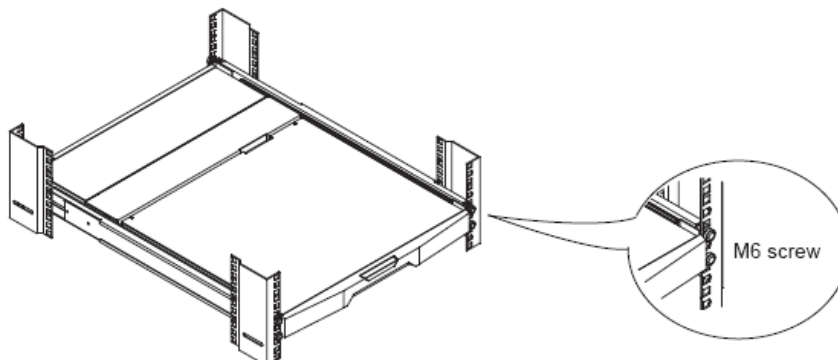

1.10 How to use the slides

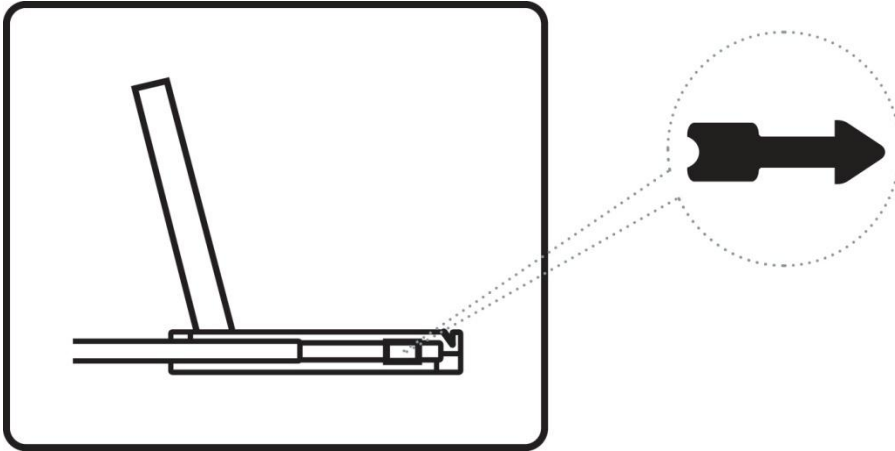

Figure 1.

- A black arrow release button is located on the outside of each slide. (Shown in **Figure 1**).

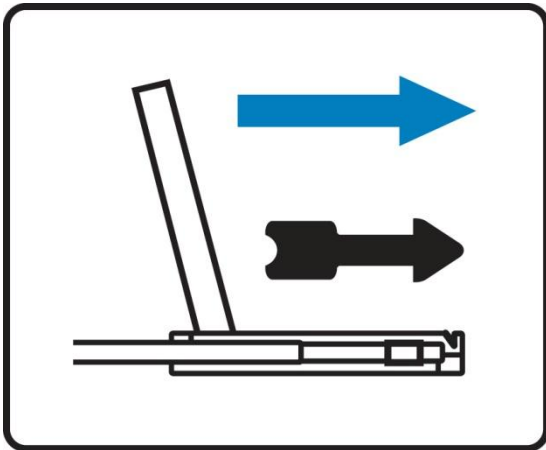

Figure 2.

- Pull and hold the black arrow button on either side of the LCD keyboard drawer to unlock. (Shown in **Figure 2**).

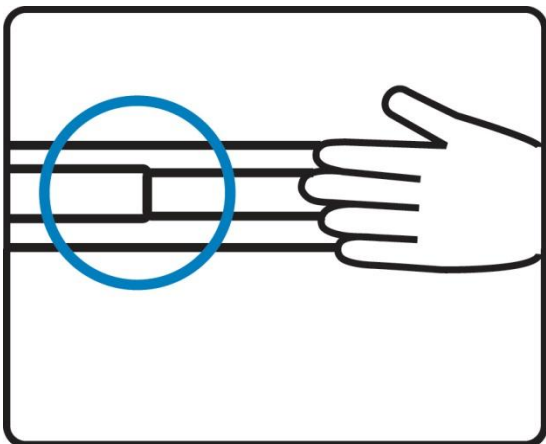



Figure 3.

- Push the LCD keyboard drawer into the rack. (Shown in **Figure 3**).

 **Caution** : Keep your fingers away from the slide stop

1.11 How to use the LCD Keyboard Drawer



Figure 4. Sliding out the LCD keyboard drawer by pressing the carry handle button first.

- Press the carry handle button. Gently pull the carry handle toward the front of the LCD. (shown in **Figure 4**)



Figure 5. Flipping up the LCD to a suitable angle.

- Flip up the LCD to a suitable angle. (shown in **Figure5**)



Figure 6. Operating the LCD keyboard drawer

- Operate the LCD keyboard drawer. (shown in **Figure 6**)

1.12 KVM Model Connection Diagrams

<p>RW / RWS119-MUIP 1613 16 – Port KVM (1 local + 1 CAT5/6 remote + 1 IP remote users)</p>	
<p>RW / RWS119-MUIP 1614 16 – Port KVM (1 local + 2 CAT5/6 remote + 1 IP remote users)</p>	
<p>RW / RWS119-MUIP 1624 16 – Port KVM (1 local + 1 CAT5/6 remote + 2 IP remote users)</p>	
<p>RW / RWS119-MUIP 3213 32 – Port KVM (1 local + 1 CAT5/6 remote + 1 IP remote users)</p>	
<p>RW / RWS119-MUIP 3214 32 – Port KVM (1 local + 2 CAT5/6 remote + 1 IP remote users)</p>	
<p>RW / RWS119-MUIP 3224 32 – Port KVM (1 local + 1 CAT5/6 remote + 2 IP remote users)</p>	

1.13 KVM Diagrams

Models:

RW119-MUIP1613
RWS119-MUIP1613

RW119-MUIP1614
RWS119-MUIP1614

RW119-MUIP1624
RWS119-MUIP1624

KVM Server Connection

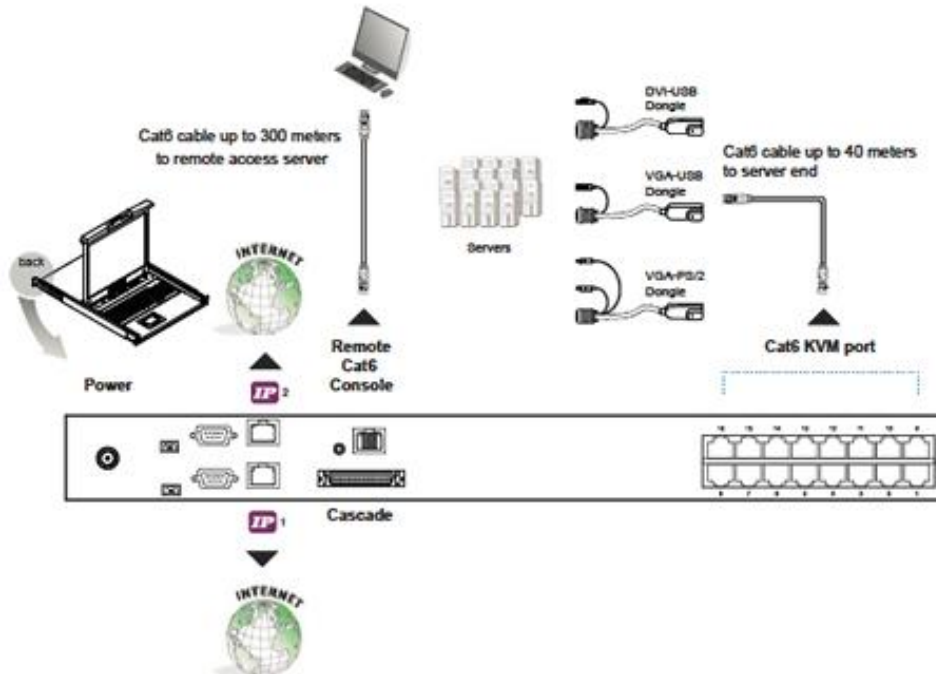

KVM Cascade

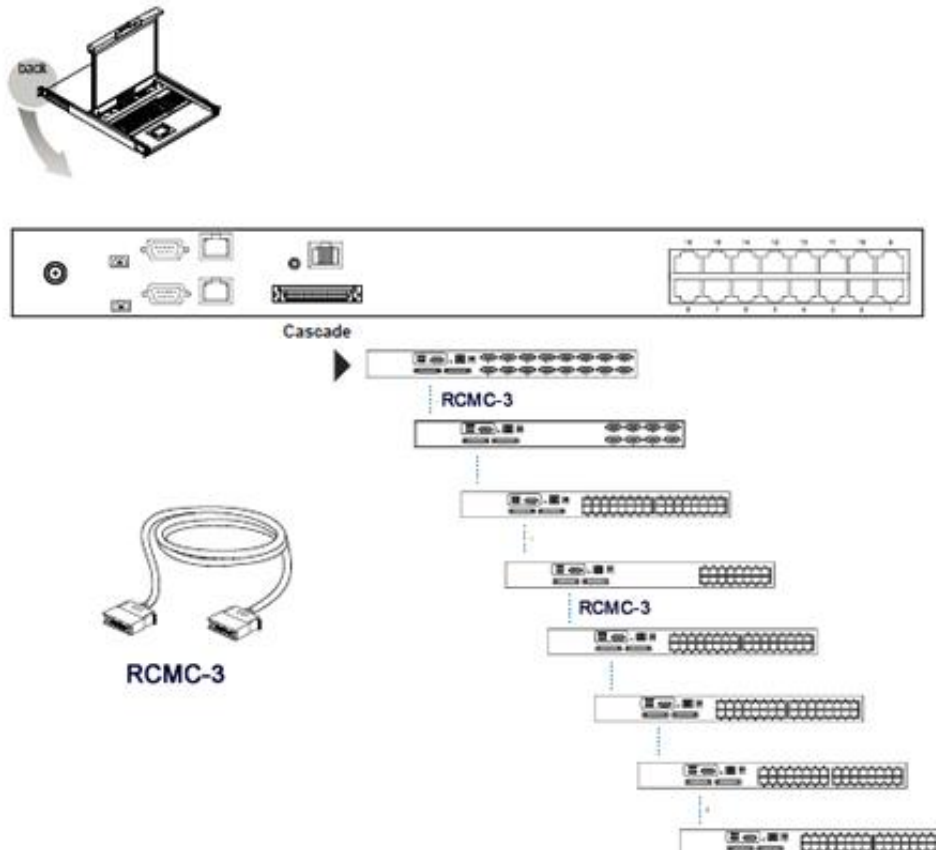

1.14 KVM Diagrams

Models:

RW119-MUIP3213
RWS119-MUIP3213

RW119-MUIP3214
RWS119-MUIP3214

RW119-MUIP3224
RWS119-MUIP3224

KVM Server Connection

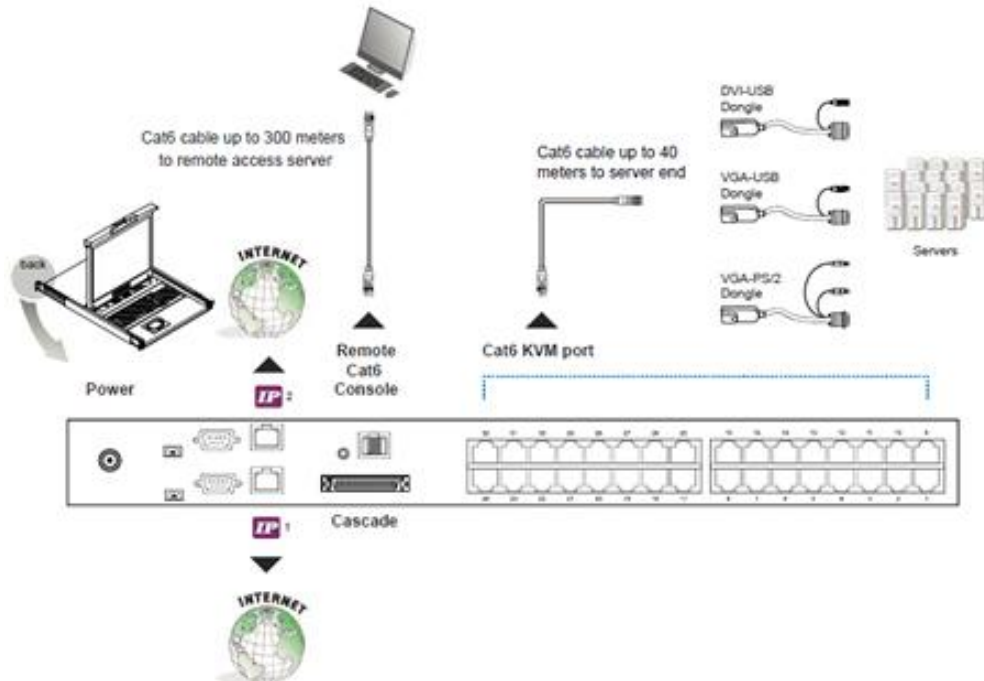

KVM Cascade

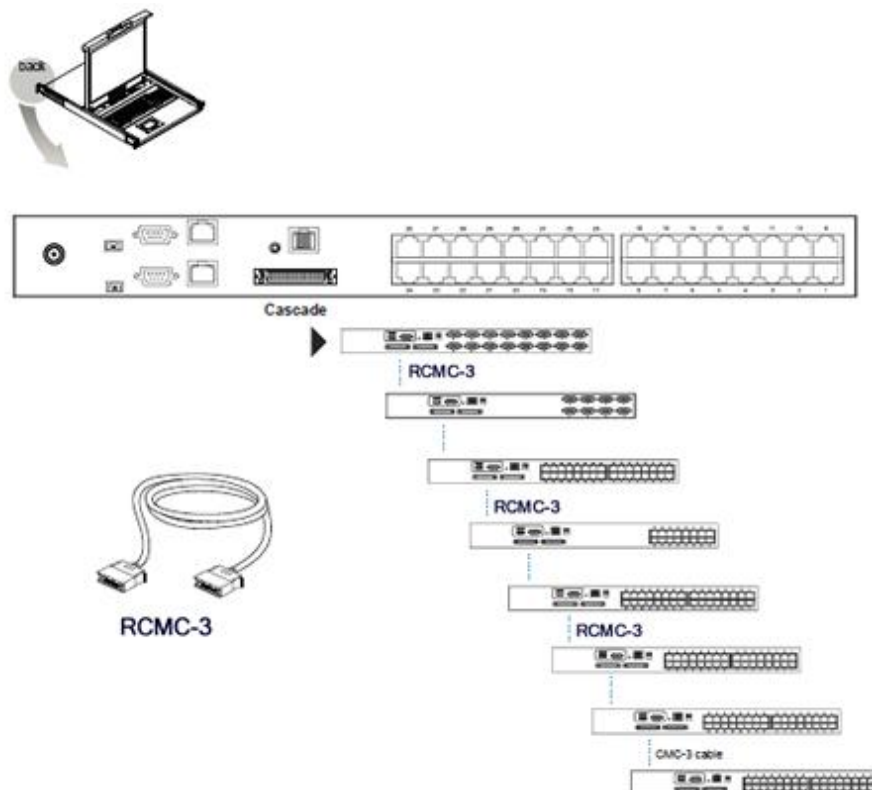

1.15 KVM Connection KVM Cable Connection & Receiver Diagrams (All Models)

Receiver

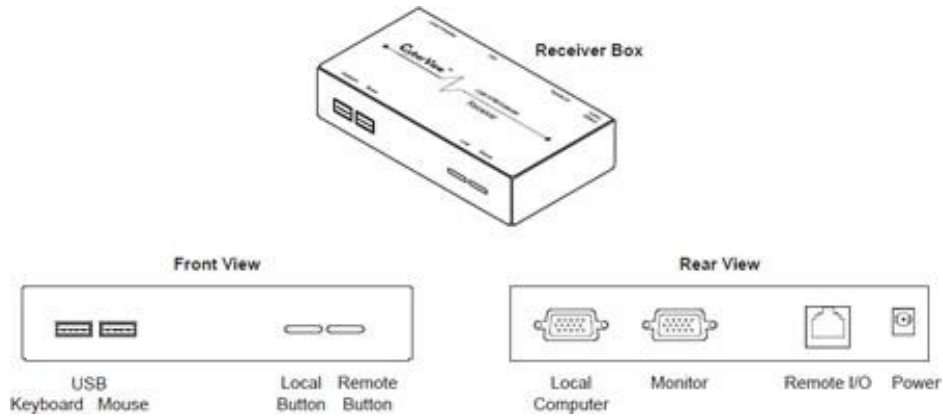

Receiver Connection

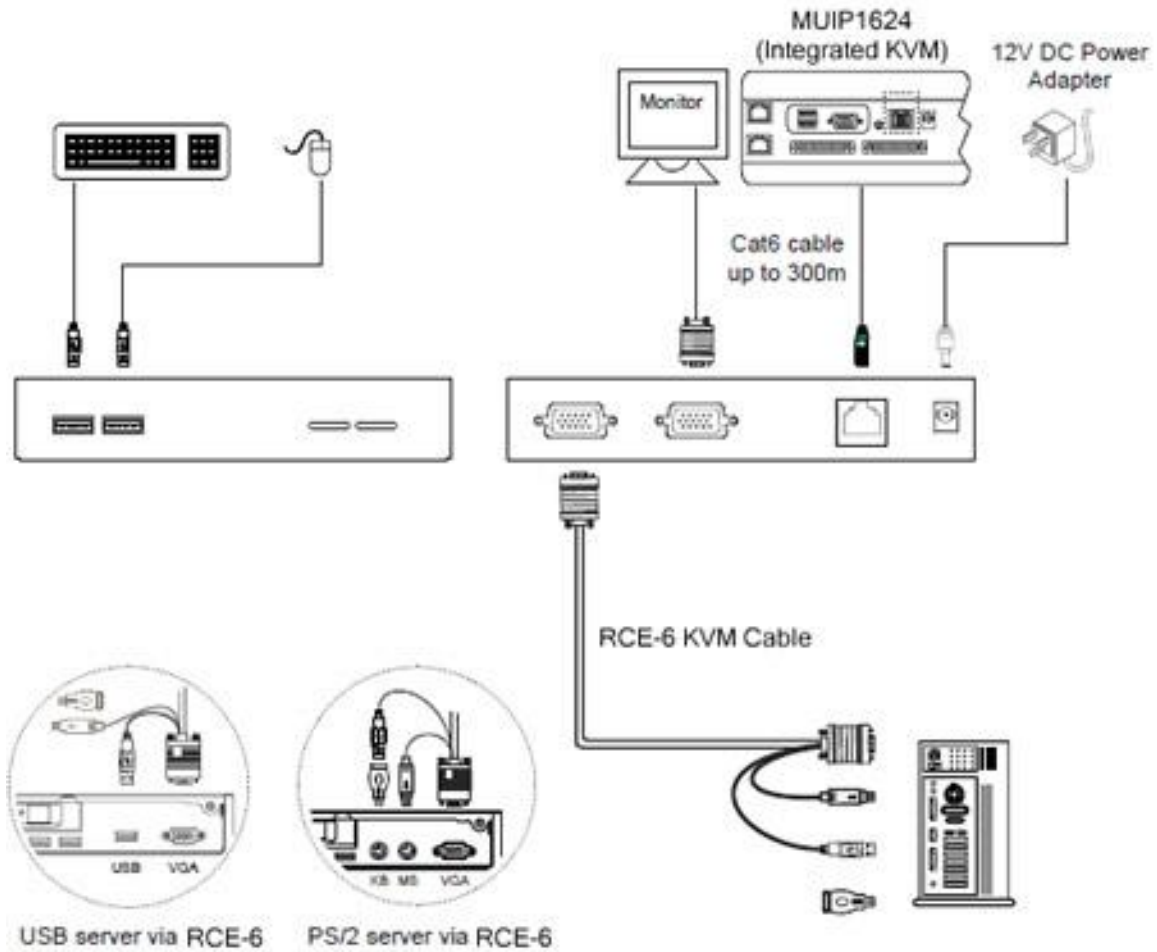



Caution: The LCD keyboard drawer is hot-pluggable, but components of connected devices, such as the servers and KVM switch, may not be hot-pluggable. Plugging and unplugging cables while servers and KVM are powered on may cause irreversible damage to the servers, KVM and LCD keyboard drawer. Before attempting to connect anything to the LCD keyboard drawer, we suggest turning off the power to all devices before connecting them. Apply power to connected devices again only after the LCD keyboard is receiving power. The company is not responsible for damage caused in this way.

Chapter 2 Operation

2.1 On-screen Display Operation

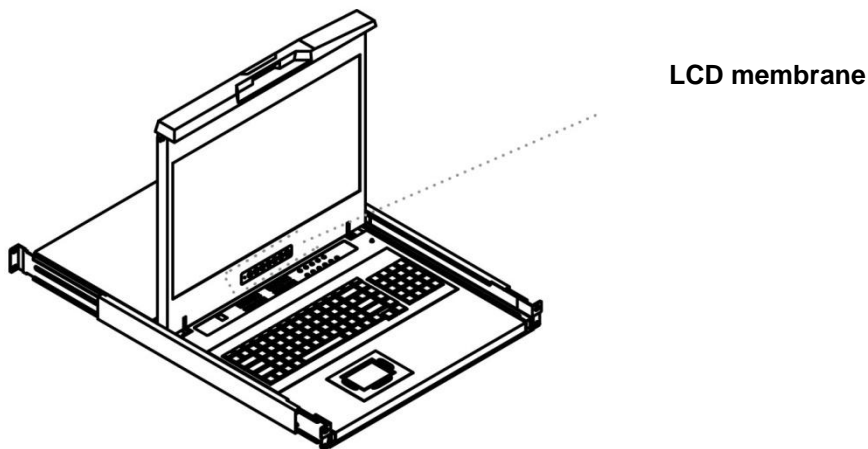

Membrane Switch	Function
	Power light Green = On Orange = Power saving
	Power on / off LCD
	Display the OSD menu
	Scrolls through menu options and adjusts the displayed control (To auto adjustment by pressing the button for 5 seconds)
	Exit the OSD screen Toggle analog, digital & video connection (DVI-D and video options only)

2.2 On-screen Menu

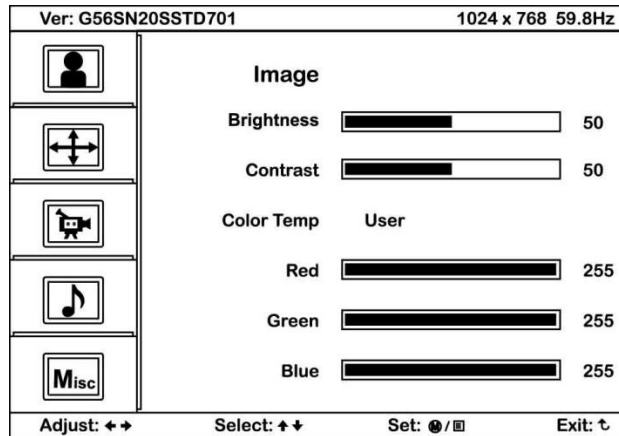

OSD Configuration Page



Image:

To enter into the brightness, contrast, colour temp, red, green, and blue

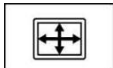

Geometry:

To enter into the auto adjust, H position, V position, phase and clock



Video:

To enter into the colour, tint, sharpness, noise reduction, DCDi and TV Setup



Audio:

To enter into volume, bass, treble, balance, AVL and mute



Misc:

To enter into the language, OSD position, graphic mode, OSD time, ratio, reset and timer

Chapter 3 LCD Specifications

3.1 LCD Rackmount Widescreen Series Specifications

Item	Description	
Form Factor	1U rack mounting on slide-out rails	
LCD Manufacturer		-
Series	RW	RWS
Diagonal Size	Wide 19" TFT	Wide 19" TFT
Max. Resolution	1440 x 900	1152 x 900 (Direct)
		1440 x 900 (Native)
Brightness (cd/m ²)	300	300
Color Support	16.7 M	16.7 M
Contrast Ratio (typ.)	1000:1	1000:1
Viewing Angle (H/V)	160° x 160°	160° x 160°
Display Area (mm)	408 x 255	408 x 255
Try Response Time (ms)	1.3	1.3
LCD Panel MTBF (hrs)	50,000	50,000
VGA Signal Input	Analog RGB, 0.7Vp-p	
Sync. Type	Separate H/V, Composite, SOG	
Resolution	720 x 400, 70 Hz	
	640 x 480, 60/ 70/ 72/ 75 Hz	
	800 x 600, 60/ 70/ 72/ 75 Hz	
	1024 x 768, 60/ 70/ 75 Hz	
	1152 x 864, 60/ 70/ 75 Hz	
	1280 x 720, 60/ 70/ 75 Hz	1280 x 720, 60/ 75 Hz
	1280 x 1024, 60/ 70/ 75 Hz	1280 x 1024, 60/ 75 Hz
	1440 x 900, 60 Hz	
	--	1152 x 900, 66 Hz
Plug & Play DDC	EDID 1.3	
Console Port (Combo)	DB-15 connector for VGA / keyboard / mouse (Combo interface)	DB-15 connector for VGA / keyboard / mouse Support USB servers or Combo KVM switches
Power Input	Auto-sensing 100 to 240VAC, 50 / 60Hz	
Power Consumption	Max. 48 Watt, Standby 5 Watt	
Compatibility	Multi-platform - Mix PCs, SUNs, IBMs, HPs & DELLs.	
Regulation Approval	FCC, CE, UL*	

3.2 Keyboard & Mouse

For RW119 series

Supporting layouts

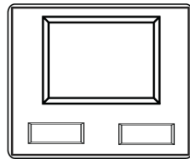
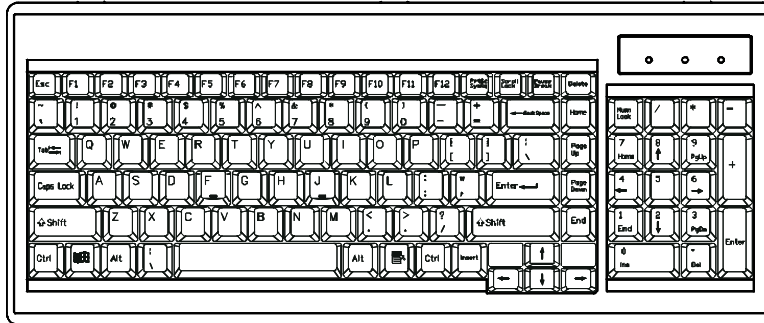

Ne N keyboard integrated with Touchpad

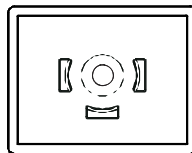
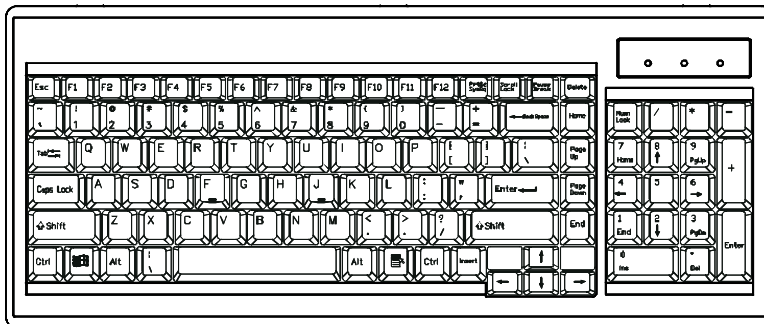

Nb N keyboard integrated with trackball

3.2 Keyboard & Mouse (Continued)

For RWS119 series

Supporting layouts

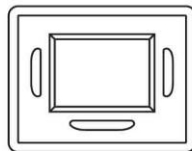
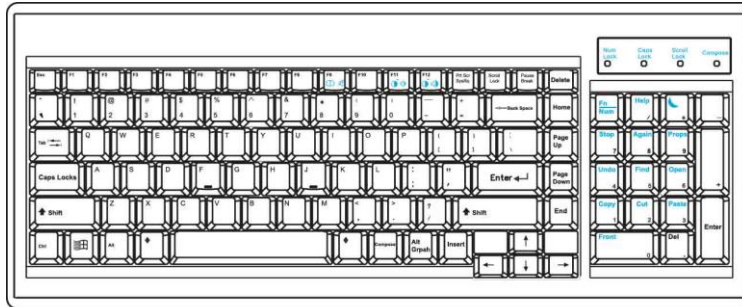

NSe

NS keyboard integrated with touchpad



- Incorporates SUN keys, including Stop, Cut, Paste, Compose, Copy and Help
- 104 key notepad keyboard with full numerical pad and SUN function
- USB interface

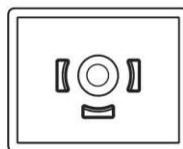
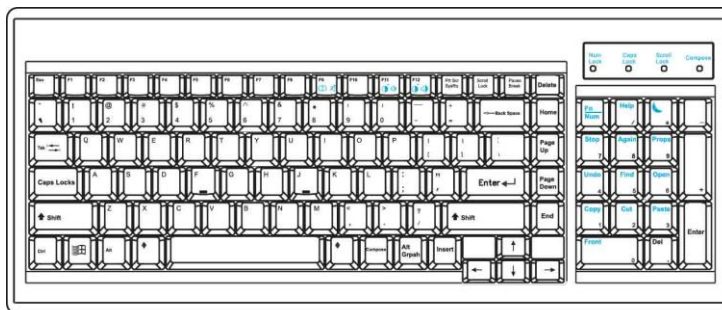

NSb

NS keyboard integrated with trackball



- Incorporates SUN keys, including Stop, Cut, Paste, Compose, Copy and Help
- 104 key notepad keyboard with full numerical pad and SUN function
- USB interface

3.3 How to use “NS” keyboard

- NS SUN-compatible keyboard incorporates SUN short-cut keys.

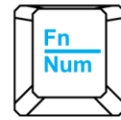
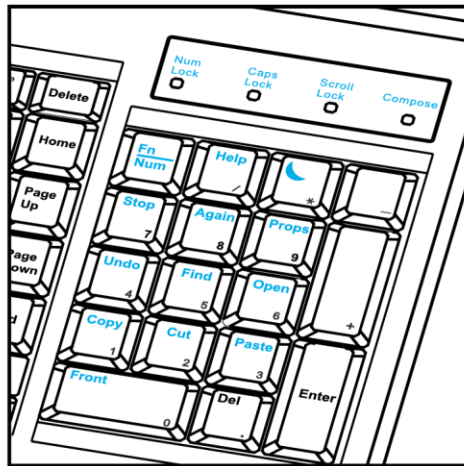

- Press the Fn/Num button to switch the color the Num LED.

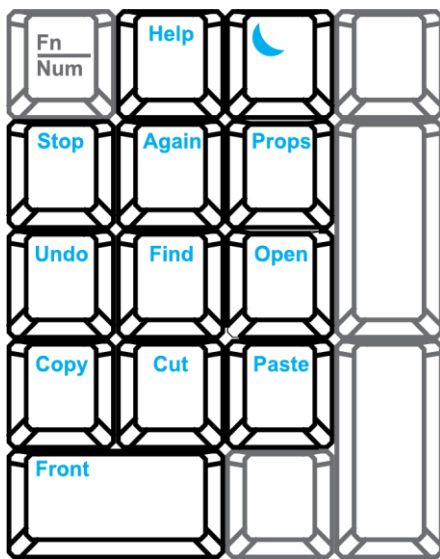

Num LED in Off mode

Key pad acts as a SUN Solaris system administration command mode

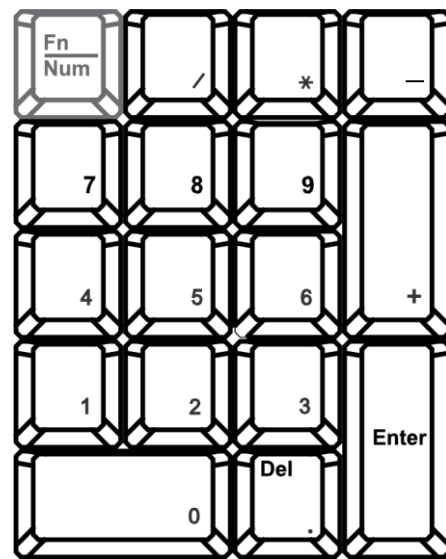

Num LED in Green color

Key pad acts as a normal key pad mode

Three Audio / Display keys are located in the upper-right corner of the NS keyboard:

- Audio: Mute, decrease in volume and increase in volume.
- Display: Degauss, decrease contrast and increase contrast.
- Please ask your supplier for full details

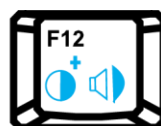
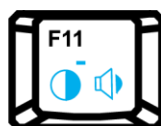
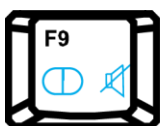

Chapter 4 KVM Specifications

4.1 Matrix-Multi-User CAT 5/6 KVM Over IP

	Matrix-Multi-User 16-port CAT5/6 KVM Over IP	Matrix-Multi-User 32-port CAT5/6 KVM Over IP
KVM Model	MUIP1613 / MUIP 1614 / MUIP1624	MUIP3213 / MUIP 3214 / MUIP3224
KVM Ports		
Number of Ports	16	32
Connectors	RJ-45	
Connectivity	Combo 4-in-1 KVM cable, up to 6, 10, 15 ft & DVI-D / VGA connector dongle up to 40 meters (132 feet) CAT6 / CAT5 / CAT5e cable	
Local Console		
Graphical Connector	1 x HDDB15-pin VGA	
Resolution	1600 x 1200	
Input Device	2 x USB type A for keyboard & mouse	
Remote Console		
Graphical Connector	HDD 15-pin, VGA	
Resolution	1600 x 1200	
Input Device	2 x USB type A for keyboard & mouse	
Remote I/O	RJ45 via CAT5 / CAT5e / CAT6 cable up to 1,000 feet	
IP Remote Console		
User Management	15-user login, 1 x active user	
Security	SSL v3, RSA, AES, HTTP / HTTPS, CSR	
Browser	IE, Firefox, Safari, Netscape	
IP Access	1 x RJ45 Ethernet, 1 DB-9 serial & 1 x USB port	
Remote I/O	RJ45 via CAT5 / CAT5e / CAT6 cable up to 1,000ft	
Expansion	Up to 128 servers by 8-level cascade	Up to 256 servers by 8-level cascade
Compatibility	Multi-platform: Mix various PC, SUN, MAC, IBM, HP & DELL servers. Support: Windows Vista / 2003 / XP / 2000, Linux, Netware, Unix, DOS	
Power		
Input	100 or 240 AC at 50 or 60 Hz via IEC type cord OR AC / DC power adapter 12V@3.3A (optional)	
Option DC	12V / 24V / 48V DC input	
Consumption	Max. 24 Watt, Standby 5 Watt	
Regulatory Approval	FCC, CE, UL	
Environmental		
Operating	32°-122°F (0° to 50°C)	
Storage	23°-140°F (-5° to 60°C)	
Relative Humidity	5~90%, non-condensing	
Shock	10G acceleration (11ms duration)	
Vibration	5~500Hz 1G RMS random vibration	

Our KVM is designed to seamlessly integrate into the rear of our full range of LCD drawer solutions:

- USB Basic DB-15 KVM with either 8 or 16 ports 1U
- Cost efficient remote server management between user & equipment rooms within the building; access up to 300 meters
- Mix PS/2, USB & SUN with Multi-Platform switch capability

4.2 DVI-D Option



Remarks:

- Package includes 1 x 6ft DVI-D cable

4.3 BNC + S-Video Option

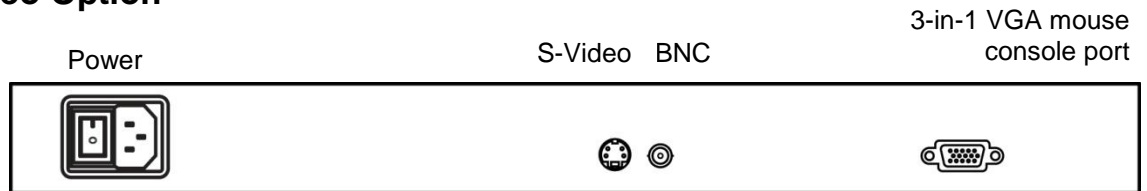

Remarks:

- Package includes 1 x 6ft S-Video cable

4.4 Audio Option

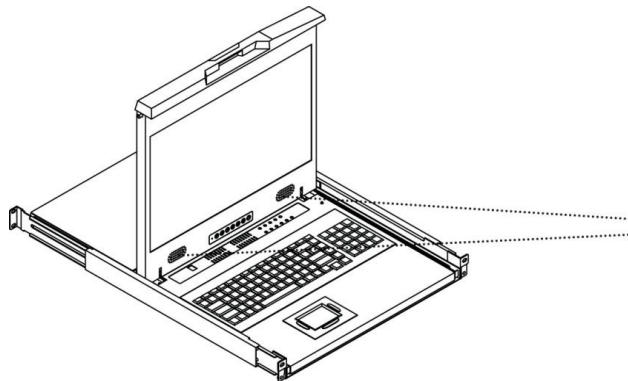

Speaker

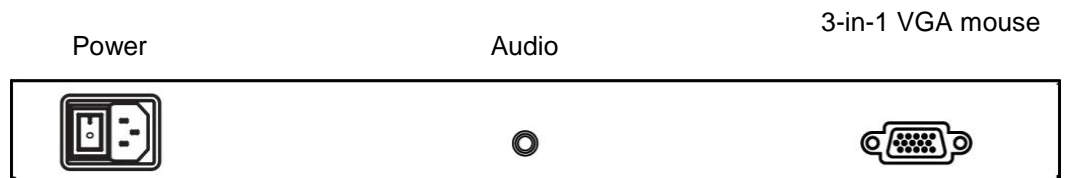

Remarks:

- Audio input is 35mm audio plug
- The speaker shares the same power with LCD.

4.5 DC Power Options

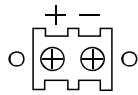

Model	12V	24V	48V
Input rating			
Input voltage:	12-Volt	24-Volt	48-Volt
Input range:	9 ~ 18V	18 ~ 36V	36 ~ 75V
Input current			
- No load	50 mA	50 mA	50 mA
- Full load	4950 mA	2450 mA	1220 mA
Output rating			
Output voltage:	12-Volt	12-Volt	12-Volt
Output current:	4.16A	4.16A	4.16A
Efficiency	84%	85%	85%

Remarks:

- Package does not include power cord and AC power adapter

Chapter 5 Troubleshooting

1. Is interference signal appeared on LCD normal when shutting down the computer?

In rare cases, interference may appear on the monitor. This may be caused by signal rate of VGA card and is considered normal. The image quality can be improved by adjusting the phase or pixel rate automatically or manually.

2. The membrane power light is not ON

Press the power ON / OFF on LCD membrane to check if the monitor is in the ON mode. Check the power cord is properly connected to the LCD keyboard drawer and power outlet.

3. Screen image is not centered or sized properly

Press the  button for two seconds to automatically adjust the image. Adjust the H-position and V-position settings via On-screen menu.

4. Is the LCD keyboard drawer hot-pluggable?

The LCD keyboard drawer is hot-pluggable, but components of connected devices, such as the servers and KVMs, may not be hot-pluggable. We suggest turning off the power to all devices before connecting them. Apply power to connected devices again only after the LCD keyboard receives power.

5. How do I adjust the resolution?

To change monitor resolution, click Start -> Control Panel -> Display. Select Setting tab to adjust the monitor resolution in Desktop Area. The available resolutions, "640 x 480", "800 x 600", "1024 x 768", "1152 x 864", "1280 x 1024", "1440 x 900", are determined by the display card in your computer.

For RWS119 Series

1. How can I adjust the monitor resolution to 1152 x 900 for SUN Micro system?

The NS solution LCD keyboard drawer will automatically detect the 1152 x 900 resolution, so no user configuration should be necessary.

2. How do I adjust the resolution in MS Windows operation system?

To change monitor resolution, click Start -> Control Panel -> Display. Select Setting tab to adjust the monitor resolution in Desktop Area. The available resolutions, "640 x 480", "800 x 600", "1024 x 768", "1152 x 864", "1280 x 1024", are determined by the display card in your computer.

3. The Stop-A hot key is not work in Trusted Solaris

The keyboard combination Stop-A (L1-A) is not available in Trusted Solaris by default. The security administrator can change this.

4. Is interference signal appeared on LCD normal when shutting down the computer?

In rare cases, interference may appear on the monitor. This may be caused by signal rate of VGA card and is considered normal. The image quality can be improved by adjusting the phase or pixel rate automatically or manually

Chapter 6 Dimensions

Model	Product Dimension (W x D x H)	Packing Dimension (W x D x H)	Net Weight	Gross Weight
RW / RWS119 – MUIP1613	442 x 600 x 44 mm 17.4 x 23.6 x 1.73"	581 x 755 x 172 mm 22.9 x 29.7 x 6.8"	24 kg 53 lb	33 kg 72 lb
RW / RWS119 – MUIP1614	442 x 600 x 44 mm 17.4 x 23.6 x 1.73"	581 x 755 x 172 mm 22.9 x 29.7 x 6.8"	24 kg 53 lb	33 kg 77 lb
RW / RWS119 – MUIP1624	442 x 600 x 44 mm 17.4 x 23.6 x 1.73"	581 x 755 x 172 mm 22.9 x 29.7 x 6.8"	24 kg 53 lb	33 kg 77 lb
RW / RWS119 – MUIP3213	442 x 600 x 44 mm 17.4 x 23.6 x 1.73"	581 x 755 x 172 mm 22.9 x 29.7 x 6.8"	25 kg 53 lb	33 kg 77 lb
RW / RWS119 – MUIP3214	442 x 600 x 44 mm 17.4 x 23.6 x 1.73"	581 x 755 x 172 mm 22.9 x 29.7 x 6.8"	25 kg 53 lb	33 kg 77 lb
RW / RWS119 – MUIP3224	442 x 600 x 44 mm 17.4 x 23.6 x 1.73"	581 x 755 x 172 mm 22.9 x 29.7 x 6.8"	24 kg 53 lb	33 kg 77 lb

The company reserves the right to modify product specifications without prior notice and assumes no responsibility for any error which may appear in this publication.

All brand names, logo and registered trademarks are properties of their respective owners.

Copyright 2009 Raloy All rights reserved.