

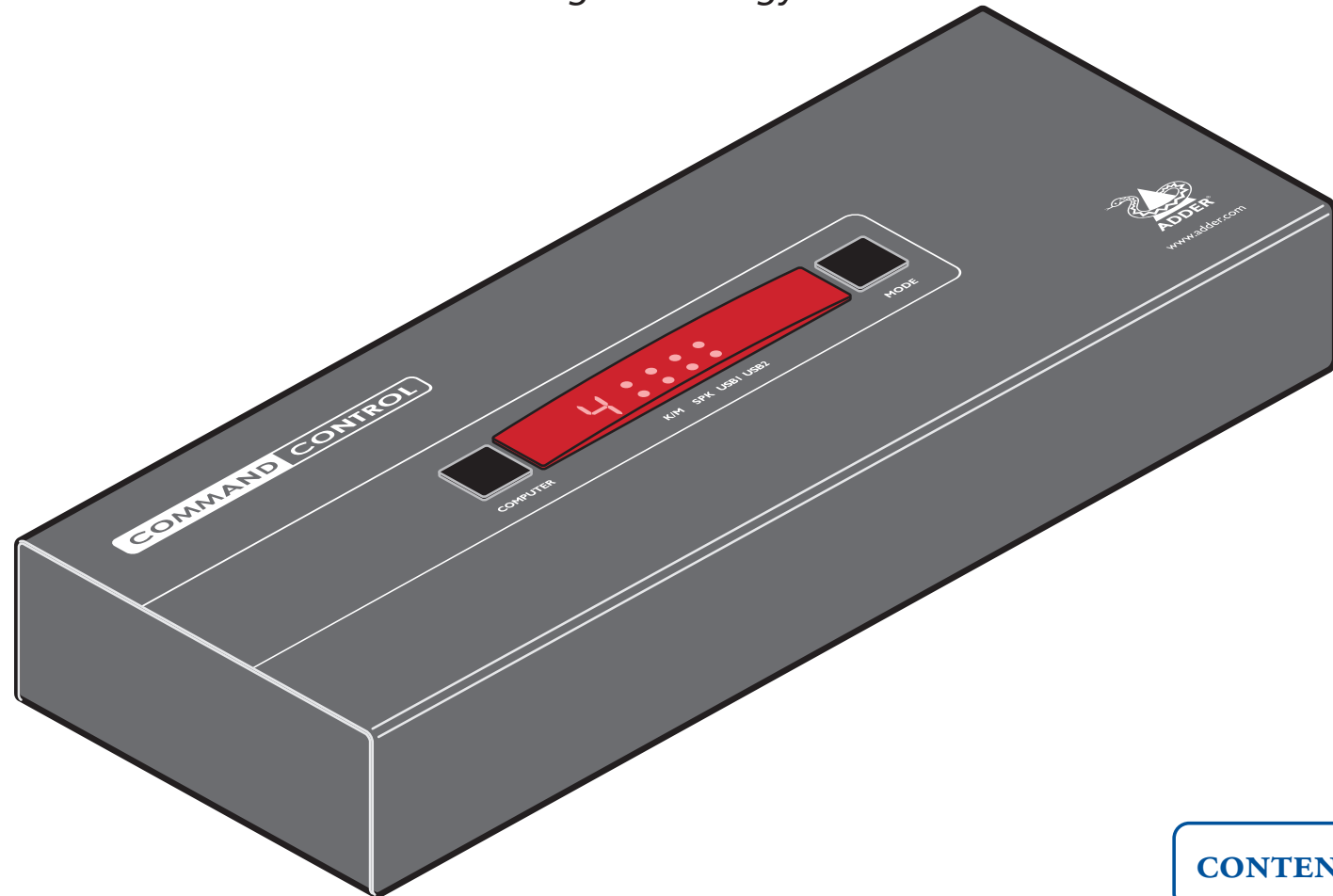

CCS4-USB

Four-port keyboard and mouse switch

Now with Free-Flow switching technology



CONTENTS

Contents



Welcome

Introduction	2
What is Free-Flow?	3
What is True Emulation?.....	4
CCS4-USB features - top and rear	5
What's in the box	6
What you may additionally need	6

Installation

Locations	7
Mounting	7
Connections	8
User console	8
Computer systems	8
Power connection	9
Optional RC4 remote control	10
Using the RC4 with the CCS-XB module	10
Optional LED monitor indicator connections.....	11
Checking the CCS4-USB firmware version	12
Switching control by computer.....	13

Configuration

Using the configuration menu	14
General configuration.....	15
Changing hotkeys.....	15
Mouse switching	15
Miscellaneous functions	15
OPTIONS port speed	15

Free-Flow configuration.....	16
Installing the standard configuration application.....	16
Configuring a standard Free-Flow system.....	16
Multi-Monitor Free-Flow configuration	17
Installing drivers and multi-monitor config app	17
Configuring multiple monitors	18
Configuring LED monitor indicators.....	19
Additional Free-Flow operations and settings.....	20
Performing upgrades	21

Operation

Selecting a computer.....	23
To select a computer using the Free-Flow utility.....	23
To select a computer using the control panel.....	23
To select a computer using hotkeys	24
To select a computer using the mouse buttons.....	25
To lock access to the computers	26

Further information

Getting assistance.....	27
Appendix 1 – Cable pin-outs.....	28
Safety information	29
Warranty	29
Radio Frequency Energy.....	30

WELCOME

INSTALLATION

CONFIGURATION

OPERATION

FURTHER INFORMATION

Welcome



Introduction

The CCS4-USB (Command and Control Switch, four port, USB) is a compact unit created to allow a single operator to access information and control operations across numerous systems and screens. With the CCS4-USB switch, you can use a single USB keyboard and USB mouse to fulfil functions that previously required four separate sets. This provides immediate savings in both desk space and also the time required to access and control up to four systems and screens. The CCS4-USB features our [True Emulation](#) technology, which ensures that the full characteristics of the connected USB keyboard and mouse are passed to every system.

In addition to switching the keyboard and mouse, the CCS4-USB can also share a set of speakers and two separate USB peripherals between the four systems. This can be done either in concert with the keyboard and mouse (and each other) or totally independently.

The CCS4-USB switch can be used in combination with various Adder extender products (such as AdderLink Infinity, X50 and X-DVIPRO) to extend the distance between the user and the computers under control.

Switching between the systems connected to the CCS4-USB can be achieved in five different ways:

- The innovative [Free-Flow](#) automatic switching utility,
- The COMPUTER button on the top panel,
- Keyboard hotkey combinations,
- Mouse button combinations,
- The optional remote control selector.

Where additional feedback is required as to which systems and screens are selected at any time, the optional [CCS-XB](#) kit provides discreet stick-on LED monitor indicators. When a system/screen is selected, a corresponding LED monitor indicator illuminates (in a choice of colours) to confirm the action.

The video displays are connected directly to their respective systems as usual. A single USB link (plus an optional speaker connection) is made between each system and the CCS4-USB switch.

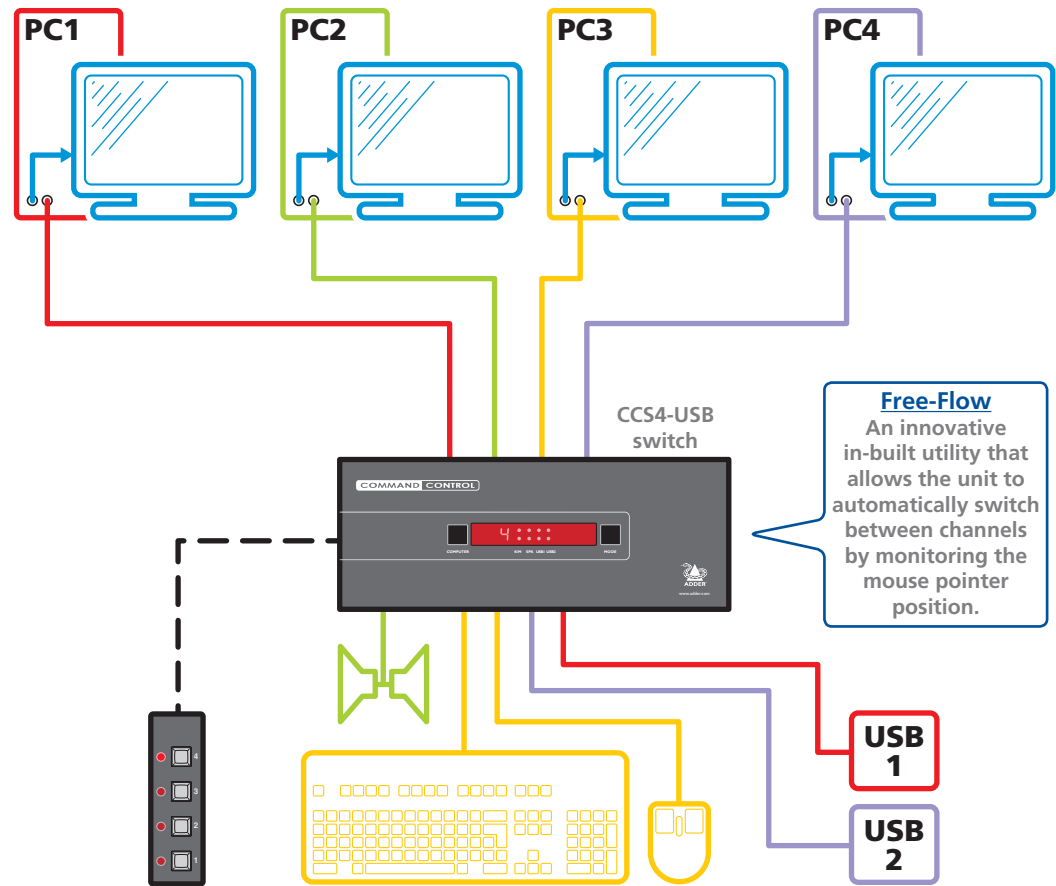

The optional remote control allows the CCS4-USB switch to be neatly concealed amongst the cabling.

The keyboard/mouse, the speakers and two individual USB channels can be collectively or separately switched through to each PC system. These are electronically switched to the required system using any of five methods: Free-Flow utility, CCS4-USB switch control panel, keyboard key-presses, mouse buttons or optional remote control.

WELCOME

INSTALLATION

CONFIGURATION

OPERATION

FURTHER INFORMATION

What is Free-Flow?

The Adder Free-Flow represents true innovation in KVM switching. For the first time, Free-Flow allows users to automatically switch between target computers simply by moving the mouse pointer from screen to screen. What makes this such a revolution is that you no longer need software to be installed on your mission critical computers in order to do this. Adder Free-Flow resides on the switch itself, sensing screen boundaries and instantaneously switching keyboard and mouse to the defined target computer. Free-Flow can be configured for almost any combination of screens using the included application which allows you to declare the individual screen sizes and visually position each one relative to the others.

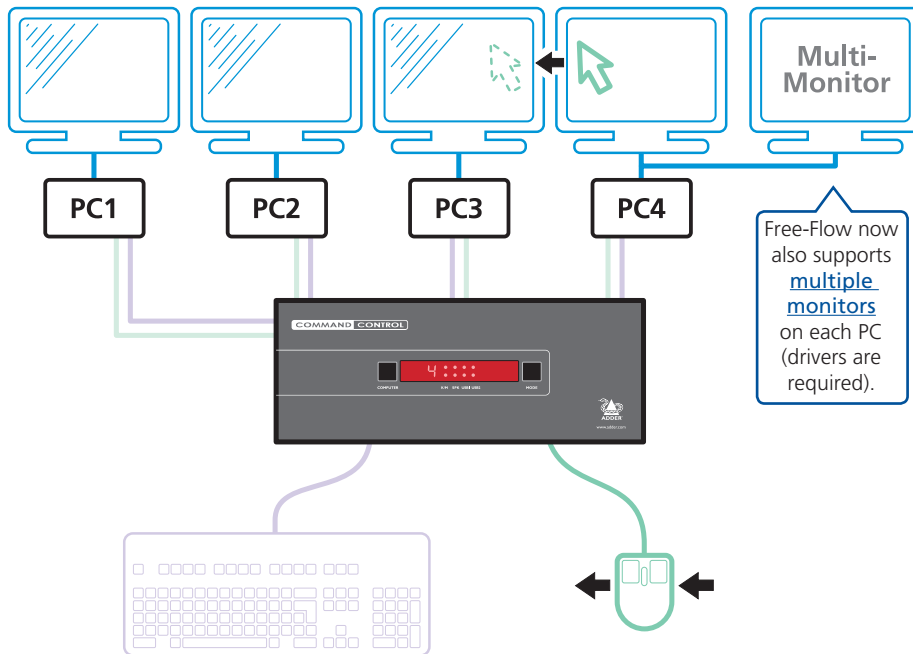

Free-Flow consists of special code within the CCS4-USB switch plus an intuitive graphical configuration application. First you inform the Free-Flow configuration application how many screens you have, their pixel resolutions and how they are physically arranged (e.g side-by-side, vertical stack, square formation, etc.). You then download this information to the CCS4-USB switch and this is used during operation to determine the precise moment to switch from one screen/system to the next.

The beauty of Free-Flow is its simplicity of configuration and operation. Once the initial configuration has taken place, all monitoring and switching is handled within the CCS4-USB without need for extra connections or software utilities.

Issues when using Free-Flow

- The CCS4-USB switch must have a minimum of firmware version 2.00 installed to operate with Free-Flow. See [Performing upgrades](#) for details.
- When computers and their displays are not currently selected, the CCS4-USB 'parks' their mouse pointers in the bottom right corner of the screen. In most cases this will cause no issues, however, it may be noticeable in circumstances such as the following:
 - If the task bar is set to auto hide and it is positioned either along the bottom of the screen (as default) or along the right hand side, then the task bar will automatically reappear when the mouse pointer is parked.
 - When playing full screen video, the on-screen controls (play, pause, seek etc.) will very likely be revealed when the mouse pointer is parked.
 - To cure the either of the above issues, it is possible to alter the [mouse parking position](#).
- The mouse will not flow across the screens while any mouse buttons are pressed down - this prevents undesired behaviour when dragging windows around or group-selecting items.
- By default, Linux operating systems use relative mouse data which Free-Flow cannot use. A 'udev rule' is available that allows Linux to use absolute mouse positioning, thus enabling standard Free-Flow (not Multi-Monitor mode) to operate.
- Multi-Monitor Free-Flow is for use with the Windows operating system only and requires specialist driver to be installed on each PC. See [Multi-Monitor Free-Flow configuration](#) for details.

More information

- [Free-Flow configuration](#)
- [Multi-Monitor Free-Flow configuration](#)
- [Operation: Selecting a computer](#)

What is True Emulation?

True Emulation represents a significant breakthrough in sharing USB devices between two or more computer systems. Until this point, the problem has been how to create a USB switch that provides all of the following:

- Quick, transparent and reliable switching,
- Accurate representation of the connected USB keyboard and mouse,
- Switching control via the connected USB keyboard and/or mouse.

The difficulty in achieving all of the above requirements has been due to the complexity of the USB standard. This has led to various problems that have spawned a number of possible solutions.

Enumerated USB switching

The earliest attempts to switch USB devices applied a relatively 'hands off' approach. Enumerated USB switches are the electronic equivalent of those old mechanical KVM switches with a large knob on the front.

Enumerated switches are so called because a connected USB device will be required to perform a full initiation (a process called *Enumeration*) every time it is switched; just as if you had pulled out the plug and then reconnected it.

Enumerated switches simply pass all signals straight through between the USB device and the computer, they do not attempt to interpret any data. For most devices, this offers an advantage because the switch just leaves them to get on with their jobs without any interference or any hit on performance. However, it means that a USB keyboard or mouse cannot be used to control the switching process - a quick and simple control method expected by most users. Reliability of switching is also an issue that has plagued enumerated switches, especially when used with certain USB devices and particular operating systems.

Emulated USB switching

The issues with interpreting the complex USB data streams and recreating (or *Emulating*) the identity of attached USB devices were eventually solved, leading to the creation of the Emulated USB switch.

A neat side effect of the technique used is that each computer can be fooled into thinking that the USB device is permanently connected to it, even when the device is switched to another computer. This means that the enumeration process for the USB device takes place only once, during the first power on. After that, a computer merely sees a dormant version of the USB device whenever the device is actually connected to a different computer.

However, it remains a complex task to dynamically assume the identity of a USB device, distribute it among the connected computers and maintain all of the necessary signals, states and processes. Therefore, manufacturers have previously relied upon a fixed keyboard and mouse profile that is declared to each computer, regardless of the actual connected devices. This precluded the use of any special keyboard or mouse features over and above the standard layouts.

True Emulation

Mindful of the limitations associated with the previous USB switching techniques, we set about creating a more effective and elegant solution. After a great deal of research and development, *True Emulation* is the result.

True Emulation allows the complete identity of the keyboard and mouse to be copied and then presented to all of the connected computers. This means that any keyboard offering specialist function keys or any mouse with extra features will be fully supported at each computer. As with the previous emulation method, the unselected computers will continue to see the identities of the keyboard and mouse, which means that no enumeration is necessary when their link becomes active once again. This not only helps to speed up the rate of reconnection, but also raises the reliability of switching because USB links are at their most vulnerable during the enumeration process.

True Emulation relies upon a high speed circuit, called an Emulation Engine, to fully emulate the USB device identities and also interpret keyboard and mouse data streams. The result is full support for KVM switching control via hotkey presses or the third button/scroll wheel of a mouse.

True Emulation is not necessarily required by other USB devices, which is why you will also find two enumerated circuits included (shown in green within the block diagram) alongside the True Emulation feature (shown in blue). This allows those other USB devices to operate at their highest speeds, without any intervention. The enumerated circuits benefit greatly from the USB Hubs that are jointly used with the True Emulation system. Because they interface directly and permanently with each computer, they help to stabilise the dormant links, making errors during enumeration much less likely.

The dual switching arrangement provides further flexibility because the True Emulation and enumerated sections can be switched in unison or independently of each other, as required. Thus, your various peripherals can operate with different computers at the same time. Please see software release notes for a list of supported products.

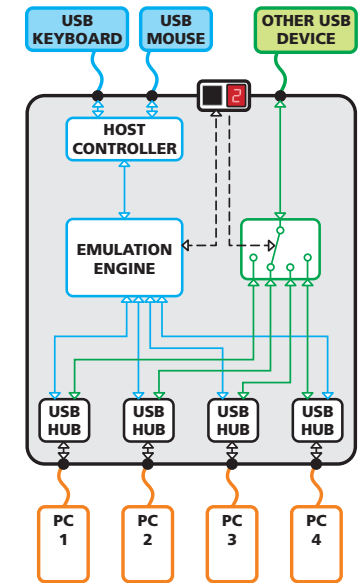

The emulated section of the switch is shown in blue and handles only the keyboard and mouse. The green enumerated section of the switch handles other USB devices and also uses the USB hubs to link with the computers.



- WELCOME
- INSTALLATION
- CONFIGURATION
- OPERATION
- FURTHER INFORMATION

CCS4-USB features - top and rear

The CCS4-USB switch is housed within durable, metallic enclosure with all connectors situated at the rear panel. The smart top panel features the control buttons and the operation indicators.

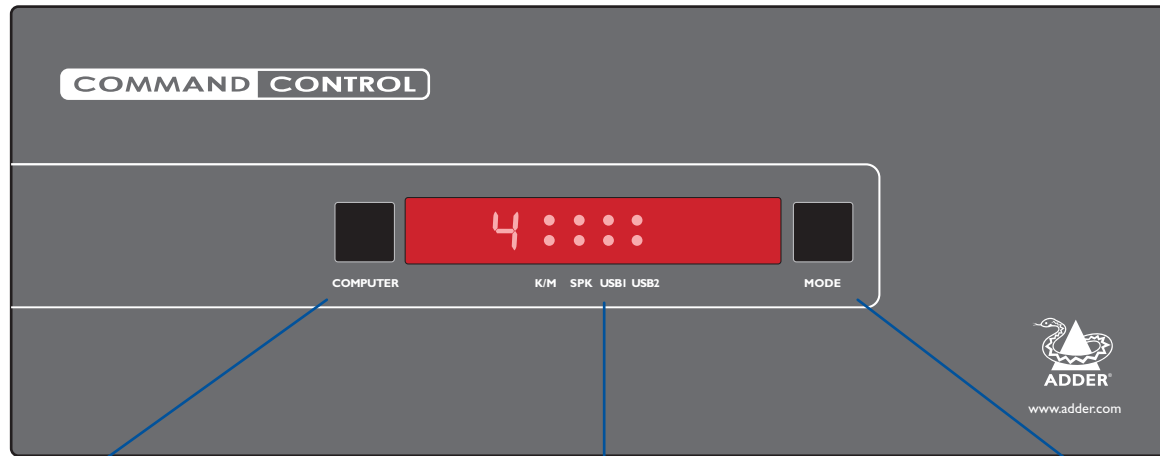

COMPUTER button
Press to change to the next computer channel.

Indicators

The upper four indicators scroll across in sequence when the [Free-Flow](#) utility is engaged. The lower four indicators (**K/M**, **SPK**, **USB1**, **USB2**) show which peripherals are switched to the current computer channel OR (as you begin pressing the MODE button) the peripherals that will be switched during the next press(es) of the COMPUTER button. The seven segment numeric display indicates the computer channel that is currently active.

MODE button
Press to determine which peripherals should be switched to another computer channel (will occur when the COMPUTER button is pressed).

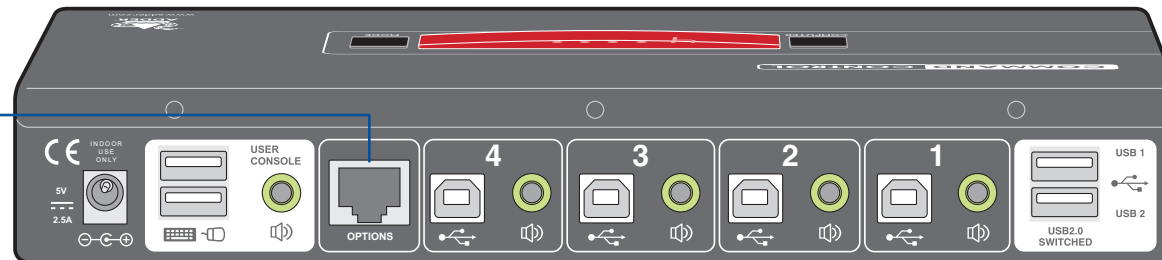

Options port

- This 10p10c port can separately support the following functions:
- Remote control - allows a standard Adder RC4 four button remote control unit to be used to switch channels (see [Optional RC4 remote control](#) for details).
 - LED monitor indicators - the optional CCS-XB module links to here and provides multiple light up monitor indicators.
 - Upgrades - used to update the internal firmware when necessary by connecting to a computer.

Power input
The power supply connects here.

User console
Connect a USB keyboard and mouse plus optional speakers to these connectors.

Computer channels
Each computer connects to one of these four channels via a USB B-type connector and an audio 3.5mm jack input.

User console
Connect up to two USB devices to these connectors. These ports are switched in an enumerated manner (see [What is True Emulation?](#))

- WELCOME
- INSTALLATION
- CONFIGURATION
- OPERATION
- FURTHER INFORMATION

What's in the box



CC54-USB switch

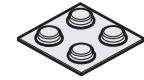
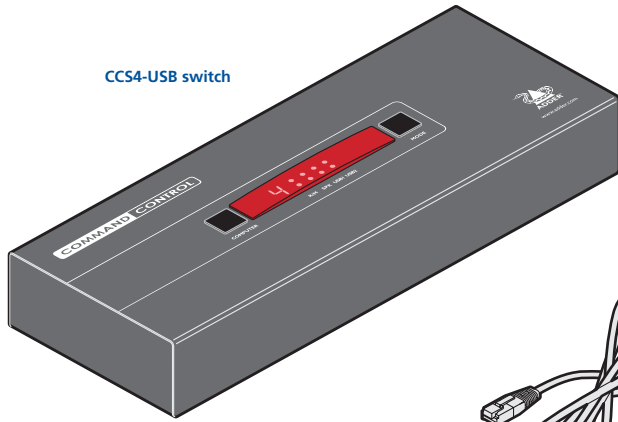

Four self-adhesive rubber feet

Power adapter (12.5W) and country-specific power lead

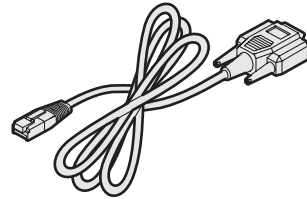
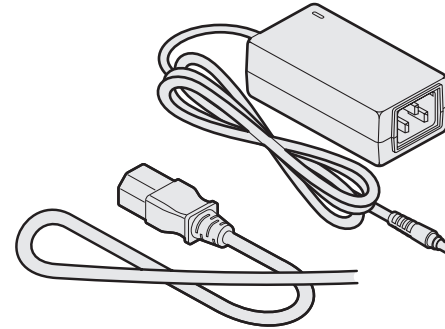

Flash upgrade cable
Part number: VSC40

What you may additionally need

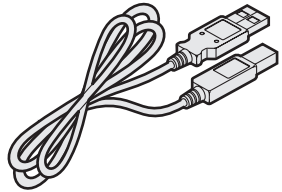

USB cable 2m (type A to B)
Part number: VSC24

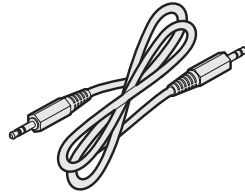

Audio cable 2m (3.5mm stereo jacks)
Part number: VSC22

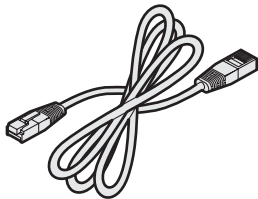

Standard 3m CAT5 patch lead
Part number: VSC23

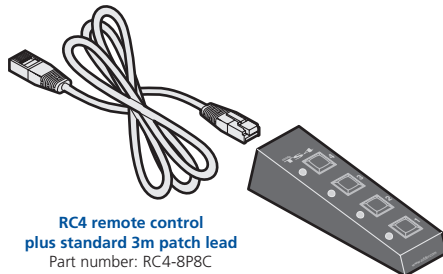

RC4 remote control plus standard 3m patch lead
Part number: RC4-8P8C

Optional CCS-XB LED monitor indicator kit

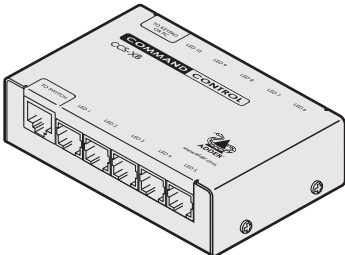

CCS-XB controller

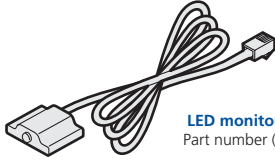

LED monitor indicator x 4
Part number (each): CCS-LED

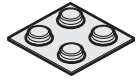

Four self-adhesive rubber feet

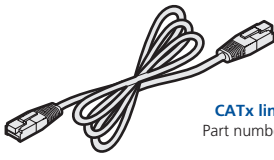

CATx link cable
Part number: VSC46

WELCOME

INSTALLATION

CONFIGURATION

OPERATION

FURTHER INFORMATION

Installation



Locations

Please consider the following important points when planning the position of the CCS4-USB switch:

- Situate the CCS4-USB switch close to the systems to which it will be connected and near to a source of mains power.
- Thanks to the optional remote control and/or Free-Flow, the CCS4-USB switch can be situated out of sight within the cabling cradle of a desk or placed adjacent to the connected systems.
- Consult the precautions listed within the [Safety information](#) section.

Mounting

Before you begin connecting to the keyboard, mouse and source systems, it is advisable to mount the CCS4-USB switch in place, either:

- On a horizontal surface using the supplied self adhesive feet, or
- Amongst the cabling at the rear of the desk.

WELCOME

INSTALLATION

CONFIGURATION

OPERATION

FURTHER
INFORMATION

Connections

Connections do not need to be carried out in the order given within this guide, however, where possible connect the *power in* as a final step

User console

The ports that make up the user console are where you attach the peripherals which will be shared between the computer systems. Ensure that power is disconnected from the switch.

To connect peripherals to the user console

- 1 Position your peripheral devices in the vicinity of the switch such that their cables will easily reach.
- 2 **Keyboard and mouse:** Attach the leads from your USB keyboard and mouse to the USB sockets specifically labelled with keyboard and mouse symbols. The keyboard and mouse will operate in any of the USB sockets, however, **True Emulation** is not available on sockets labelled USB1 or USB2.

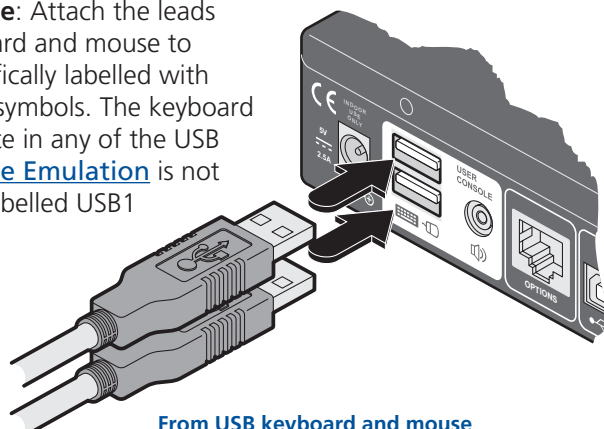

- 3 **USB devices:** Where required, attach the leads from your USB peripherals to the USB sockets labelled USB1 and USB2.

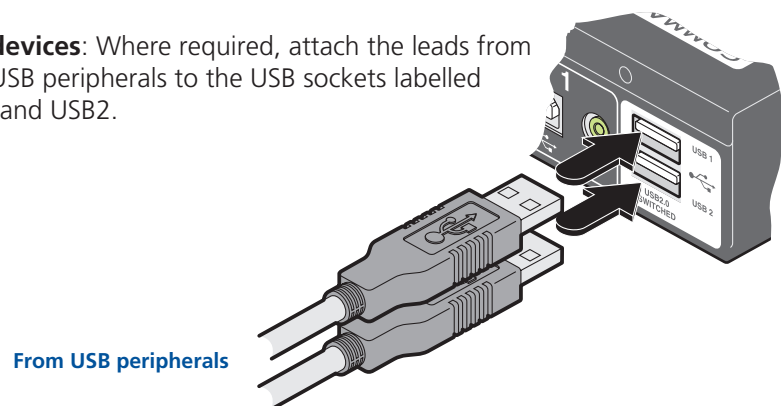

- 4 **Audio:** Where required, connect the lead from your speakers to the audio socket.

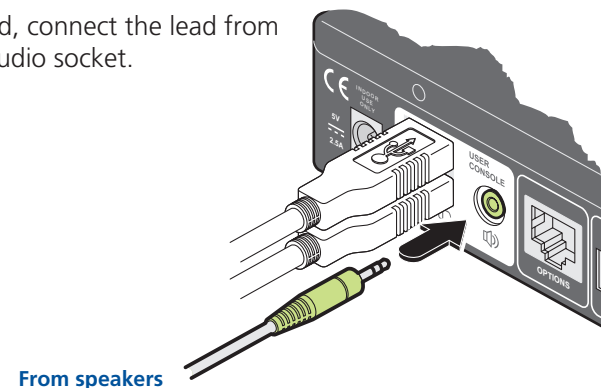

Computer systems

Each computer system is connected to the CCS4-USB switch using (up to) two cables.

To connect a computer system

- 1 Ensure that power is disconnected from the CCS4-USB switch and the system to be connected.
- 2 Use a USB cable (type-A to type-B) to link a USB port on the computer system to the USB port of the required channel on the rear of the switch.
- 3 If required, use a stereo audio link cable (3.5mm jacks at either end) to link the speaker port on the computer system to the audio port of the required channel on the rear of the switch.

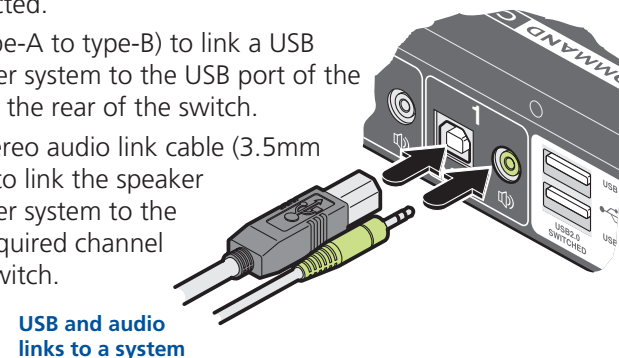

Power connection

The CCS4-USB switch is supplied with a 12.5W power adapter. There is no on/off switch on the switch, so operation begins as soon as a power adapter is connected.

To connect the power supply

- 1 Attach the output lead from the power adapter to the 5V socket on the rear panel of the switch.

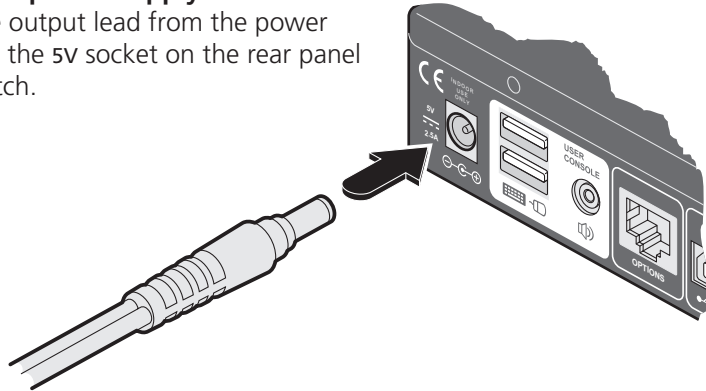

- 2 Connect the IEC connector of the supplied country-specific power lead to the socket of the power adapter.

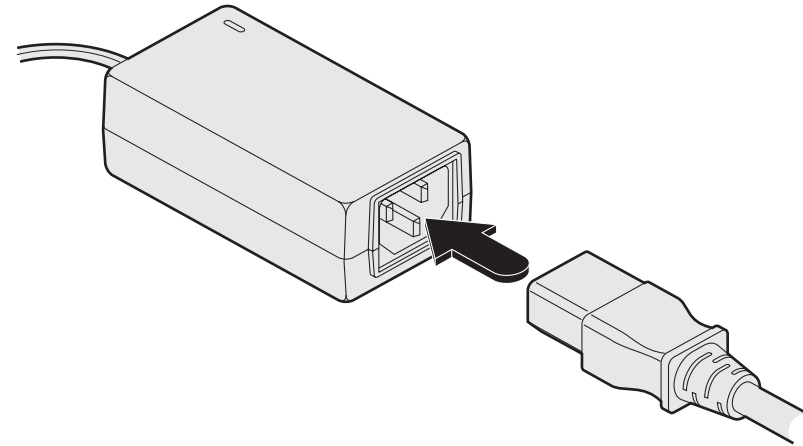

- 3 Connect the power lead to a nearby main supply socket.

Note: Both the switch and its power supply generate heat when in operation and will become warm to the touch. Do not enclose them or place them in locations where air cannot circulate to cool the equipment. Do not operate the equipment in ambient temperatures exceeding 40 degrees Centigrade. Do not place the products in contact with equipment whose surface temperature exceeds 40 degrees Centigrade.

Optional RC4 remote control

The optional RC4 remote control unit (full part number: RC4-8P8C) can be used to provide direct push button access to any channel from your desktop. The RC4 remote control is supplied with a 3 metre cable that is used to link with the **OPTIONS** port on the rear panel of the switch.

To connect the remote control

- 1 Connect either end of the supplied cable to the socket at the rear of the RC4 remote control.

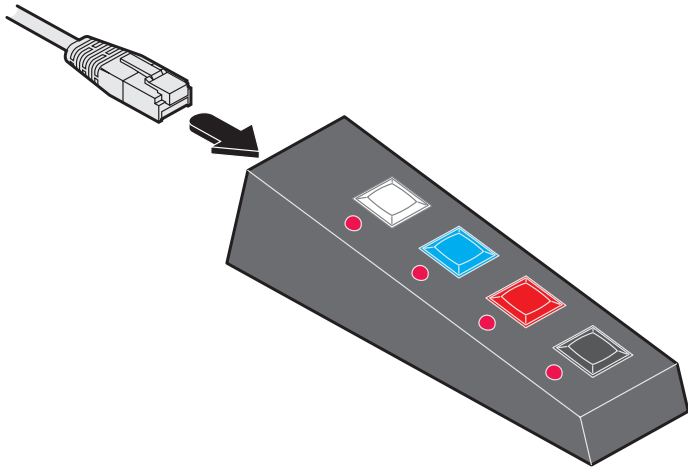

- 2 Connect the other end of the cable to the **OPTIONS** port on the rear panel of the switch.

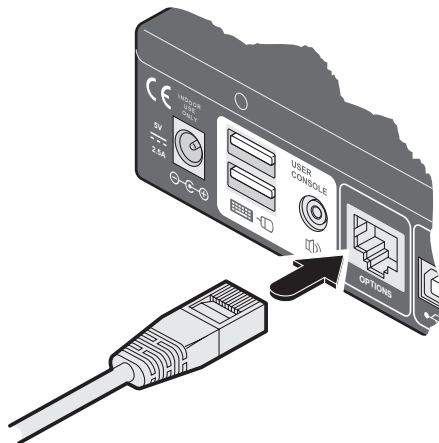

Using the RC4 with the CCS-XB module

When the optional CCS-XB LED monitor indicator module is used with the CCS4-USB switch, it requires permanent use of the latter's **OPTIONS** port which would otherwise be used to attach the RC4 remote.

However, the CCS-XB module has an output port that provides a link through to the **OPTIONS** port (to which it is connected) that can be used to attach the RC4 remote.

To connect the remote control to the CCS-XB module

- 1 Once you have used the Adder FreeFlow utility to program the CCS4-USB switch (see the section [Configuring LED monitor indicators](#)), unplug the flash upgrade cable from the **TO KEYPAD OR PC** port of the CCS-XB module.
- 2 Use the patch cable supplied with the RC4 kit to link the RC4 to the **TO KEYPAD OR PC** port of the CCS-XB module.

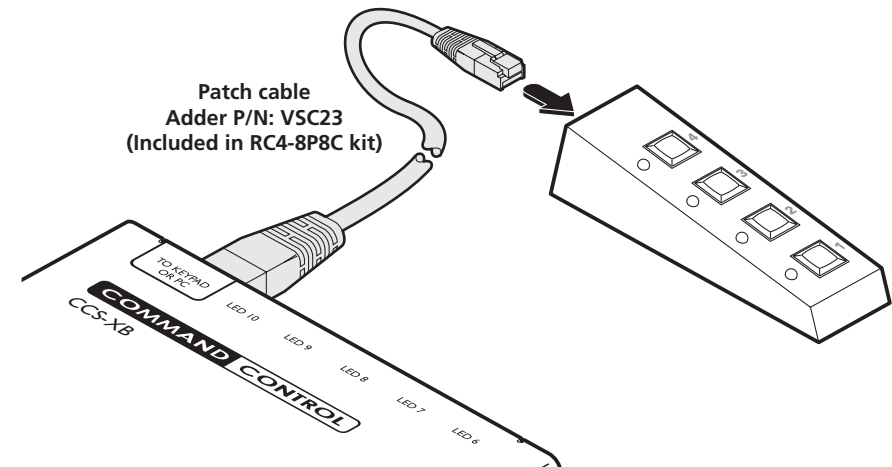

The RC4 remote can now be used in the usual manner to select the required channels.

Note: If any reprogramming of the CCS4-USB is required, you will need to temporarily disconnect the RC4 unit to allow the computer to be reattached.

Optional LED monitor indicator connections

The optional CCS-XB module enables you to add LED (Light Emitting Diode) monitor indicators to each of your video display screens to show which are active.

Note: The CCS4-USB switch requires firmware version 2.0 or later to be installed. Please see [here](#) for details about how to check.

The optional CCS-XB module connects to the **OPTIONS** port of the main CCS4-USB switch. Each individual LED monitor indicator then connects to one of the ten ports on the CCS-XB module.

Notes: The CCS-XB module MUST be connected before the switch is powered on, otherwise the module will not be recognised. Also, if the module is temporarily disconnected from the switch during operation, communication between the two will cease and the switch will need to be re-powered with the CCS-XB module attached.

Before operation of the LED indicators can occur, it is necessary to temporarily connect the CCS4-USB switch to a Windows computer. This will allow you to use the Adder Free-Flow application to program the required operation of the switch. Please see [Configuring LED monitor indicators](#) for details about using the Adder Free-Flow configuration application.

To connect the CCS-XB module and monitor indicators

- 1 Remove power from the switch. Use the flat cable supplied with the CCS-XB kit to link the module to the **OPTIONS** port of the CCS4-USB switch.

*Note: If the optional RC4 remote control is connected to the **OPTIONS** port, remove this first. It can be attached to the CCS-XB module later (see [here](#)).*

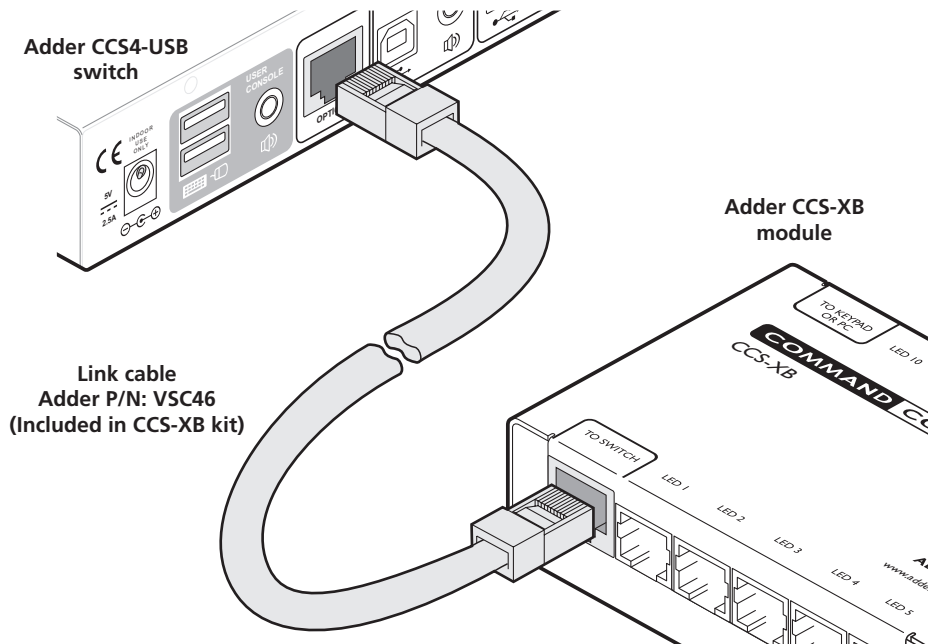

- 2 Link each LED monitor indicator to a port on the CCS-XB module - ports 1 to 4 are most commonly used.

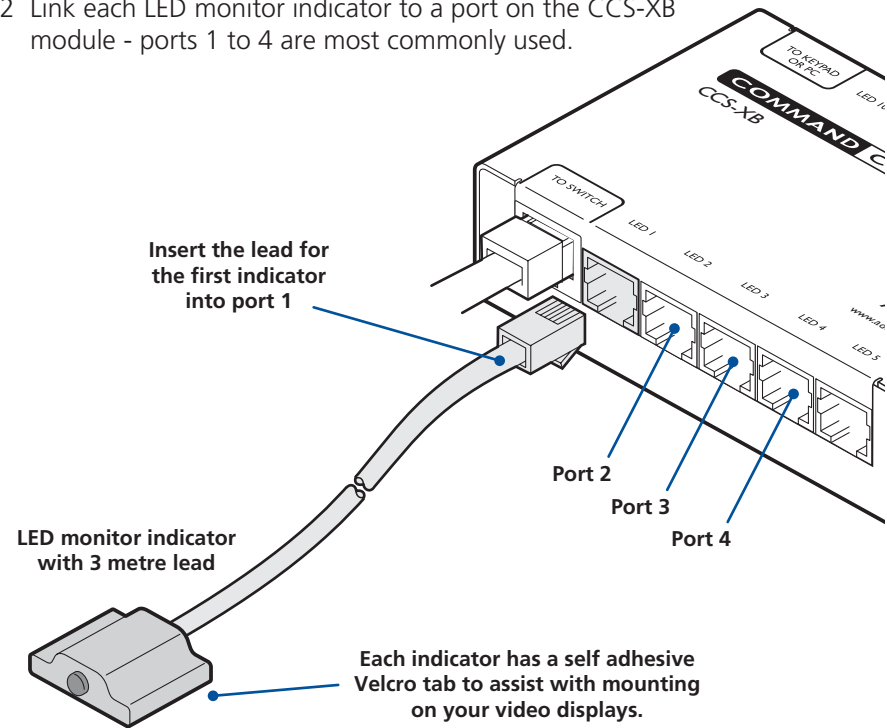

- 3 You need to tell the CCS4-USB which LED monitor indicator to illuminate (and in which colour) for each channel. To do this connect your computer to the **TO KEYPAD OR PC** port of the CCS-XB module (while it remains connected to the CCS4-USB switch). Please see the section [Configuring LED monitor indicators](#).

- 4 Apply power to the switch.

Note: If required, the PC connection can be removed once programming is complete.

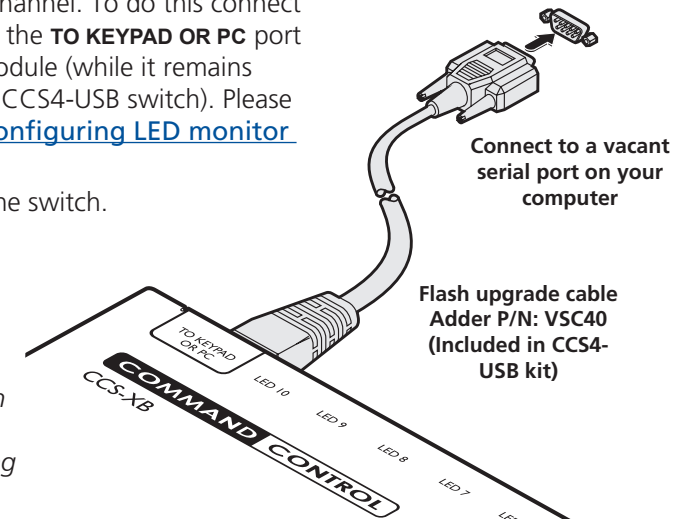

Checking the CCS4-USB firmware version

In order to operate correctly with the CCS-XB, it is important that your CCS4-USB has firmware version 2.0 (or greater) installed. If in doubt you can check the firmware version of your CCS4-USB as follows:

- 1 With your CCS4-USB powered on and with a USB keyboard attached, press and hold the **COMPUTER** button for roughly six seconds until the display shows **⌂**.
- 2 On the connected keyboard, press **F** followed by **1** and then press **Enter**. The digits of the firmware version will be shown in sequence with a short pause between each. For instance **1 > 0 > 2** means that the firmware version is **1.02** and requires an upgrade.
- 3 Press **E** and then press **Enter** to return the CCS4-USB to normal operation. If your CCS4-USB unit does require a firmware upgrade, please refer to the [Performing upgrades](#) section.

Switching control by computer

The **OPTIONS** port allows an external serial input, typically from a computer, to control the selection of the various channels. You can use either the supplied flash upgrade cable (part number VSC40) or alternatively construct a custom cable to link the CCS4-USB switch and the computer. For pin-out details of the custom cable, see [Appendix 1](#).

Upon receipt of the correct code, the CCS4-USB will switch immediately to the appropriate channel.

Connecting a computer for remote control

The cable link from the computer needs to connect the transmit (TXD) line of the computer to the receive (RXD) input of the CCS4-USB and also link the ground terminals (GND) of the two devices. See [Appendix 1](#) for details.

To connect a computer remote control

- 1 Use the supplied flash upgrade cable to link the **OPTIONS** port on the rear panel of the CCS4-USB switch and a vacant serial port on the computer.

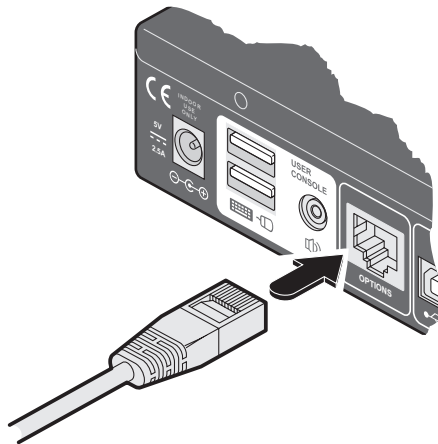

*Note: If the optional CCS-XB module is used with the CCS4-USB, connect the computer instead to the **TO KEYPAD OR PC** port on the CCS-XB module.*

Serial port parameter settings

Ensure that the chosen serial port is configured to the following:

- Baud rate: 1200
- Data bits: 8
- Stop bit: 1
- Parity: None

Channel selection codes

	ASCII Character	Hex	Decimal
• Channel 1:	'1'	0x31	49
• Channel 2:	'2'	0x32	50
• Channel 3:	'3'	0x33	51
• Channel 4:	'4'	0x34	52

Configuration

Using the configuration menu

The configuration mode allows you to determine numerous aspects of the CCS4-USB switch capabilities.

To use the configuration menu

During normal use, the seven segment display on the control panel shows the number of the currently selected computer channel. From this condition, enter configuration mode as follows:

- 1 Press and hold the control panel **COMPUTER** button for roughly six seconds.
*The display will show: **[***
- 2 On the keyboard, press the letter key for the required menu section, e.g. **[S]**
*The display will show the pressed letter, e.g. **5***
- 3 Press the number of the required setting, e.g. **[4]**
*The display will show the pressed number, e.g. **4***
- 4 Press **[Enter]** to accept the setting and return to the main menu section.
*The display will show: **[***
- 5 You can now continue with your next configuration change (go to step 2), or exit from the configuration menu (see below).

To exit the configuration menu and save changes

- Press **[E]** and then press **[Enter]** to exit and save changes.

To exit the configuration menu without saving

- Press either of the front panel buttons.

[B] Set the **OPTIONS** port baud rate

- [1]** 1200
- [2]** 2400
- [3]** 9600
- [4]** 19200
- [5]** 38400
- [6]** 57600
- [7]** 115200

You can press **[Esc]** at any point to exit from an option and return to the main menu (**[**) section.

[F] Enter the **Functions** menu

- [1]** Show current firmware version
- [8]** Reset configuration to factory defaults (**r** is displayed momentarily)

[H] Enter the **Hotkey** menu

- [1]** Ctrl + Alt
- [2]** Ctrl + Shift
- [3]** Alt + Shift
- [4]** Right Alt
- [5]** Alt
- [6]** Left Ctrl + Alt
- [7]** Right Ctrl + Alt
- [8]** Hotkeys disabled

[P] Set a new password for use with the lock mode

[S] Enter the **Switch Mode** menu

- [1]** All
- [2]** K/M + Speaker
- [3]** K/M only
- [4]** Speaker only
- [5]** USB1 only
- [6]** USB2 only

[U] Enter the **User Preferences** menu

- [1]** Enable mouse switching
- [2]** Disable mouse switching
- [7]** Cycle all ports (when using 'Hotkey + Tab' or 'Autoscan')
- [8]** Cycle only active ports (when using 'Hotkey + Tab' or 'Autoscan')



WELCOME

INSTALLATION

CONFIGURATION

OPERATION

FURTHER INFORMATION

General configuration

Changing hotkeys

CCS4-USB switches use **Ctrl** and **Alt** as their standard hotkeys. These can be changed if they clash with other software or hardware within the installation.

To change the hotkeys

- 1 Enter the [Configuration](#) menu.
- 2 Press **H** to enter the **Hotkey** menu and then press either:
 - 1** to choose **Ctrl + Alt**
 - 2** to choose **Ctrl + Shift**
 - 3** to choose **Alt + Shift**
 - 4** to choose **Right Alt**
 - 5** to choose **Alt**
 - 6** to choose **Left Ctrl + Alt**
 - 7** to choose **Right Ctrl + Alt**
 - 8** to disable the Hotkeys
- 3 Press **Enter** to accept the setting and return to the main menu section.
- 4 Press **E** and then **Enter** to exit the menu and save changes.

Mouse switching

You can enable or disable mouse switching to suit your installation requirements.

To enable/disable mouse switching

- 1 Enter the [Configuration](#) menu.
- 2 Press **U** to enter the **User Preferences** menu and then press either:
 - 1** to **Enable mouse switching**
 - 2** to **Disable mouse switching**
- 3 Press **Enter** to accept the setting and return to the main menu section.
- 4 Press **E** and then **Enter** to exit the menu and save changes.

OPTIONS port speed

You can change the speed of the OPTIONS serial port.

To change the OPTIONS port speed

- 1 Enter the [Configuration](#) menu.
- 2 Press **B** to enter the **Hotkey** menu and then press either:
 - 1** to choose **1200**
 - 2** to choose **2400**
 - 3** to choose **9600**
 - 4** to choose **19200**
 - 5** to choose **38400**
 - 6** to choose **57600**
 - 7** to choose **115200**
- 3 Press **Enter** to accept the setting and return to the main menu section.
- 4 Press **E** and then **Enter** to exit the menu and save changes.

Miscellaneous functions

To reset configuration to factory defaults

- 1 Enter the [Configuration](#) menu.
- 2 Press **F** to enter the **Functions** menu
- 3 Press **8** and then **Enter**. The display will show **r** momentarily.
- 4 Press **E** and then **Enter** to exit the menu and save changes.

To show the current firmware version

- 1 Enter the [Configuration](#) menu.
- 2 Press **F** to enter the **Functions** menu
- 3 Press **1** and then **Enter**.
The display will blank for a short while and then the major number of the firmware revision will be shown. The display will blank again and then show the first digit of the minor number. Following another blank, the second digit of the minor number will be displayed. e.g. *<blank> 1 <blank> 0 <blank> 2 <blank> equals v1.02*
- 4 Press **E** and then **Enter** to exit the menu and save changes.

To set a new password

- 1 Enter the [Configuration](#) menu.
- 2 Press **P** and then **Enter**. The display will show **:**
- 3 Enter a new password and then **Enter**. See [To lock access to the computers](#).
- 4 Press **E** and then **Enter** to exit the menu and save changes.



WELCOME

INSTALLATION

CONFIGURATION

OPERATION

FURTHER INFORMATION

Free-Flow configuration (Windows PC required)

Installing the standard configuration application

The Free-Flow configuration application is available for download from the Adder website (www.adder.com).

- 1 Install the application onto any computer (not necessarily one of the four computers linked to the CCS4-USB switch) that has a vacant serial port. Run the installation application and follow the on-screen instructions.
- 2 Use the supplied flash upgrade cable (VSC40) to link the computer serial port to the CCS4-USB **OPTIONS** port. If the optional CCS-XB module is connected to the **OPTIONS** port, then instead connect the upgrade cable between the computer serial port and the **TO KEYPAD OR PC** port of the CCS-XB module (see [Optional LED monitor indicator connections](#) for details).
- 3 Start the configuration application.

Configuring a standard Free-Flow system

Use the Free-Flow application to declare the display screens and their positions relative to each other. Then download the configuration to the CCS4-USB switch.

- 1 On the icon bar, click the red, green, blue and yellow screen icons (or use the **Screens** menu) to add the required number of display screens to the map area.

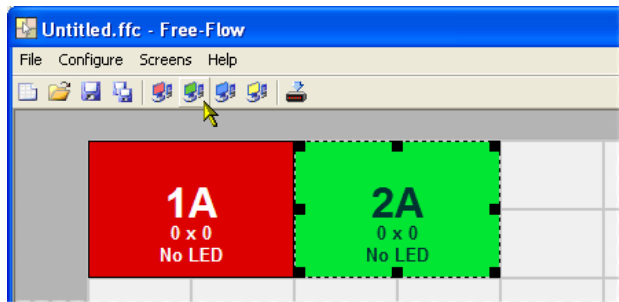

- 2 Arrange the coloured rectangular screen representations to mimic the physical layout of the actual displays, for example:



The important thing is to define where each screen edge abuts to the next so that the CCS4-USB switch can determine the correct moments to switch channels.

Use the small black squares around the perimeter of each highlighted screen representation to change their size or stretch them.

Note: The numbering of the screen representations relate directly to the four channels on the CCS4-USB switch.

- 3 Double-click on each screen representation to set the screen resolution and, optionally, add a screen name and/or configure an LED monitor indicator:

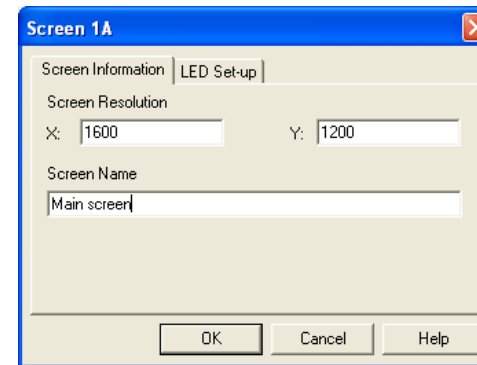

See also [Additional Free-Flow operations and settings](#)

The screen resolutions are not critical but they enable the CCS4-USB switch to accurately map the movement of the mouse onto corresponding movements of the pointer across the screens. The screen names, if used, are not downloaded to the CCS4-USB switch.

If you need to configure an LED monitor indicator, click the LED Setup tab. Please see [Configuring LED monitor indicators](#) for details.

- 4 When the screen map is complete and accurately matches the true layout of the display screens, click **File** and choose the **Save** option to store a copy of the layout. The layout will be stored as a 'Free-Flow Config file' with the extension: **.ffc**
- 5 Ensure that the optional upgrade cable is correctly installed - see 'Installing the Free-Flow configuration application' left.
- 6 To send the configuration, click the **Send Layout to Switch** option.

Click the **Configure** menu and choose the **Connection...** option to ensure that the correct computer serial port is selected and that the Baud Rate matches that of the CCS4-USB switch (1200 is the default speed).

- If the download is successful, the screen representations will briefly turn grey and the upper four indicators on the CCS4-USB switch will begin to scroll across (they will continue to do this while Free-Flow mode is enabled).
- If the download is unsuccessful, a message dialog will explain that it is 'Unable to communicate with the device'. Check the upgrade cable, check that the correct serial port is selected and check that the connection speed shown within the utility matches that of the CCS4-USB switch.

- 7 **IMPORTANT:** Once the Free-Flow configuration application has downloaded the setup, remove and reconnect power to the CCS4-USB.

Multi-Monitor Free-Flow configuration (Windows only)

Installing drivers and multi-monitor config app

In order to use Multi-Monitor mode you will need to install a Multi-Monitor Free-Flow driver (available for download from the Adder website www.adder.com/products/adder-freeflow#downloads) onto each PC that has multiple monitors attached.

- 1 On each multiple monitor PC, run the downloaded file. After accepting the licence agreement you will be prompted to choose a destination folder. Either accept the suggested location or change it, as necessary.

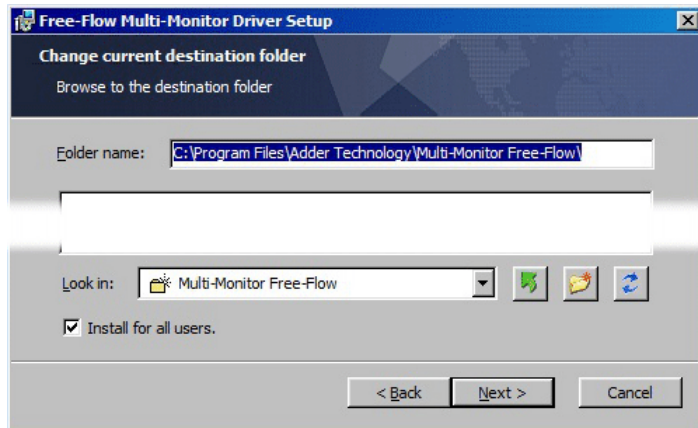

Note: The **Install for all users** option should be ticked if there are more than one user account on the PC and all need to use Free-Flow.

- 2 The options available during installation are as follows:

- **Full Install**, (this is recommended), or
- Options to install individually:
 - **Configuration App.**
This is the Free-Flow application and needs to be installed only on the PC that will be used to set up the CCS4-USB switch via the supplied flash upgrade cable (VSC40) and OPTIONS port.
 - **Visual C++ Runtime**
The C++ runtime library is a windows component that is required by the multi-monitor driver in order to run its helper applications. It is pre-installed with Windows but is offered here as an option as you may want to keep an older version already installed on your system, or you may already have a newer version in your copy of Windows.
 - **Drivers.**
Multi-Monitor Free-Flow drivers that are required on each PC that will be using Multi-Monitor.

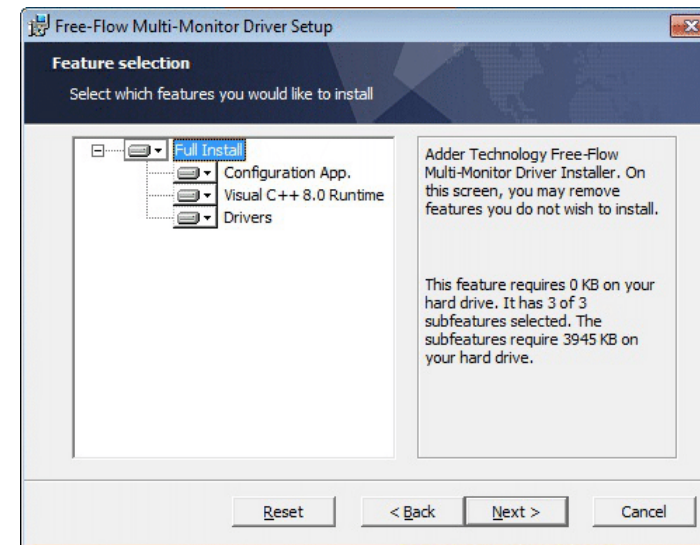

Choose the required components and click the **Next >** button.

- 3 Once the chosen components have been installed, click the **Finish** button.

Note: On the PC that will be used to set up the CCS4-USB switch, you can optionally tick 'Click to run the Free-Flow Configuration Application' in the lower left corner to immediately begin using Free-Flow - see [Configuring multiple monitors](#) on the next page for details.

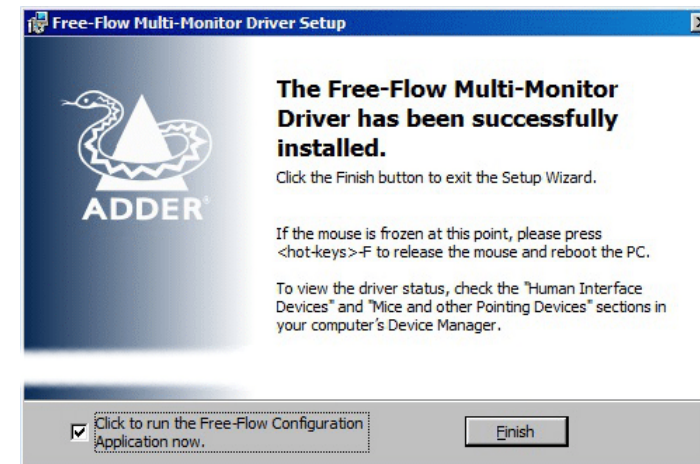

Note: On each PC that you installed the driver, a process called **mumoapp.exe** will remain running.



WELCOME

INSTALLATION

CONFIGURATION

OPERATION

FURTHER INFORMATION

Configuring multiple monitors

Multi-Monitor configuration is similar to normal Free-Flow setup except that you can add more than one display per PC, up to a total of eight per machine.

Note: It is necessary to install a driver on each PC that has multiple displays - see [Installing drivers and multi-monitor config app](#) on the previous page.

- 1 Use the supplied flash upgrade cable (VSC40) to link the computer serial port to the CCS4-USB **OPTIONS** port. If the optional CCS-XB module is connected to the **OPTIONS** port, then instead connect the upgrade cable between the computer serial port and the **TO KEYPAD OR PC** port of the CCS-XB module (see [Optional LED monitor indicator connections](#) for details).
- 2 If it is not already running, start the Free-Flow configuration application.
- 3 On the icon bar, click the red, green, blue and yellow screen icons (or use the **Screens** menu) to add the required number of display screens per computer to the map area.

For example, to add two monitors for PC 1, click the red computer icon twice. The two red monitor representations will be placed side by side within the Free-Flow map area.

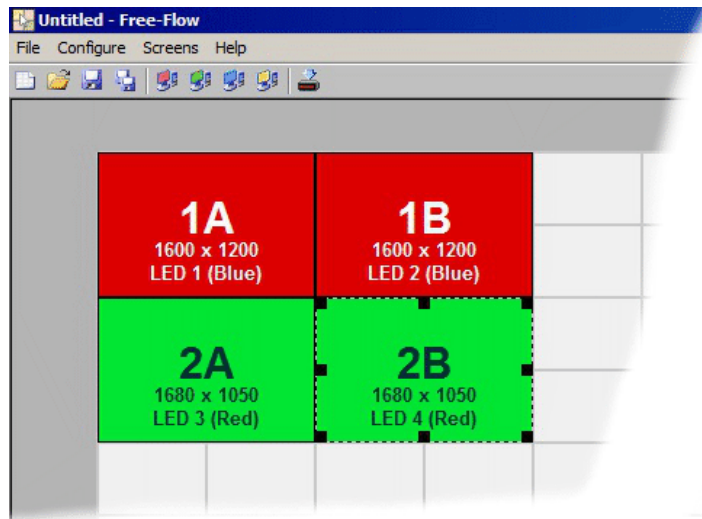

- 4 Arrange the coloured rectangular screen representations to mimic the physical layout of the actual displays. For example, you may wish to have the two screens of PC 1 side by side, with the two screen screens of PC2 below them (as shown left), or some other arrangement to reflect the actual positions of the physical monitor screens.

The important thing is to define where each screen edge abuts to the next so that the CCS4-USB switch can determine the correct moments to switch channels.

Use the small black squares around the perimeter of each highlighted screen representation to change their size or stretch them.

Note: The numbers of the screen representations relate directly to the four channels on the CCS4-USB switch, while the letters relate to the screen hierarchy attached to any single computer (i.e. A is primary, B is secondary, etc.).

- 5 Continue from **step 3** of the standard [Free-Flow configuration](#) instructions.

Configuring LED monitor indicators

When the optional CCS-XB LED monitor indicator kit is used, there are several configuration options available that allow you to customise behaviour and these are set using the [Free-Flow configuration](#) application.

Adjusting colour and brightness for all indicators

If necessary, you can impose default colour and brightness settings upon all connected LED monitor indicators. Choose the **Configure > LEDs...** menu item to display the following popup:

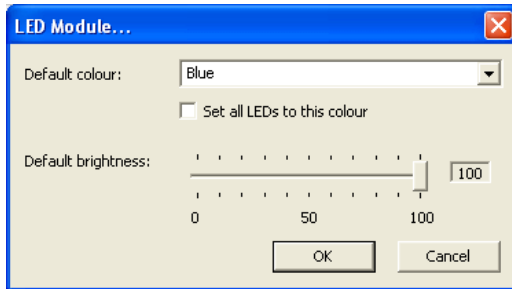

To impose a default colour on all connected indicators, choose the required **Default colour** and then tick the option **Set all LEDs to this colour**.

Use the **Default brightness** option to determine the intensity of all indicators. Click **OK** to exit and apply the required settings.

Note: Once default settings have been made you can optionally change any or all indicators individually as required using the steps outlined below.

Adjusting individual indicators

For each installed video display screen, you have the opportunity to add and configure an LED monitor indicator.

To adjust details for an individual indicator

- 1 Double-click on a screen representation (or right click on a screen representation and then choose **Properties**) to display the screen popup.
- 2 Click the **LED Set-up** tab to display the indicator details:

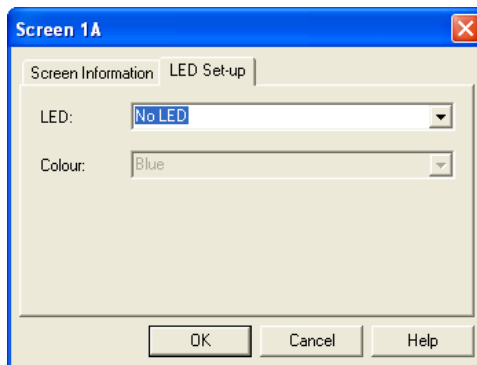

- 3 For a newly added screen the **LED:** entry will show *No LED*. Click on the drop down handle and choose the LED indicator that you wish to associate with the currently selected video display screen:

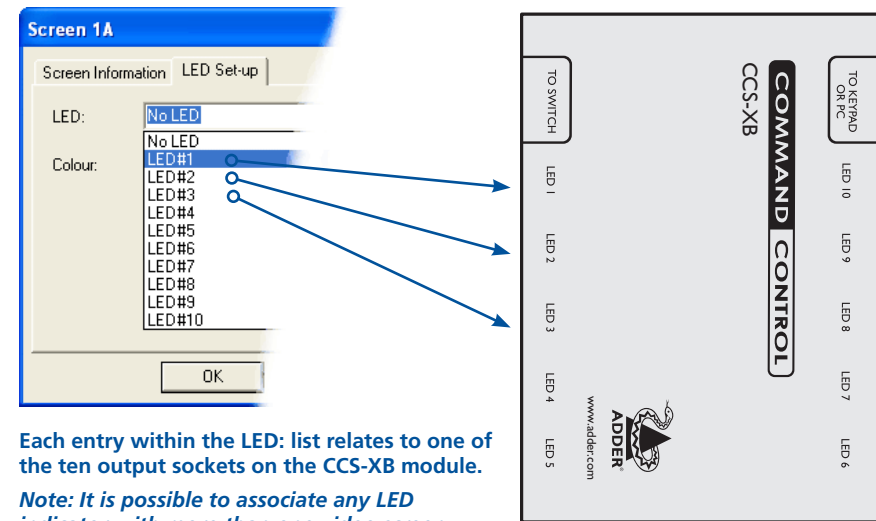

Each entry within the **LED:** list relates to one of the ten output sockets on the CCS-XB module.

Note: It is possible to associate any LED indicator with more than one video screen.

- 4 Choose the CCS-XB LED output port that you wish to associate with the currently selected video screen.
- 5 Optionally alter the colour, from the **Colour:** list, that you wish the LED indicator to display when the associated video screen is selected:

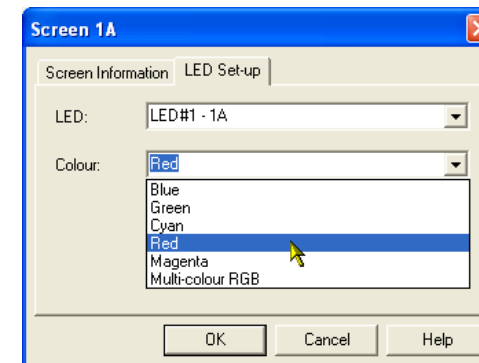

Note: Each LED indicator can only have one colour, so if you associate an indicator with more than one screen and then change the colour on a later screen assignment, it will be changed for all the screens in the list for that LED indicator.

- 6 Click OK to save and exit.
- 7 Repeat steps 1 to 6 for each screen that requires an LED monitor indicator.
- 8 Choose **Configure > Send Layout to Switch** to update the CCS4-USB switch.
- 9 **IMPORTANT:** Once the Free-Flow configuration application has downloaded the setup, remove and reconnect power to the CCS4-USB to allow the new settings to take effect.

Additional Free-Flow operations and settings

In addition to the core configuration functions, Free-Flow has a number of additional settings that you can make.

Mouse... (acceleration) setting

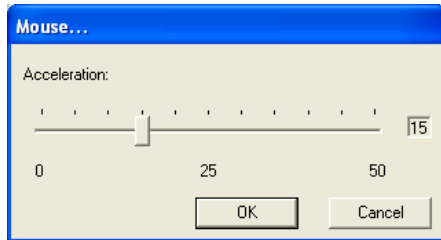

Acceleration

Mouse acceleration allows you to move the mouse pointer quickly across the large areas of the screen in response to small but sharp shifts in the mouse position. The **Configure > Mouse...** option provides settings between 0 and 50, however, a value of 12 to 15 will give a typical Windows-like default operation.

Mouse parking... setting

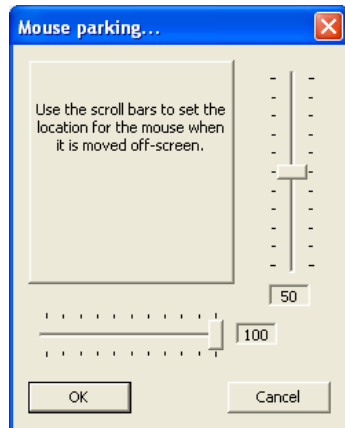

Mouse parking allows you to optionally determine where the mouse pointer for each system should be placed when the focus moves to a different system/video screen. The **Configure > Mouse parking...** option displays vertical and horizontal scroll bars. Use the scroll bars to pinpoint the position that should be used to park the dormant mouse on each screen.

Switch... settings

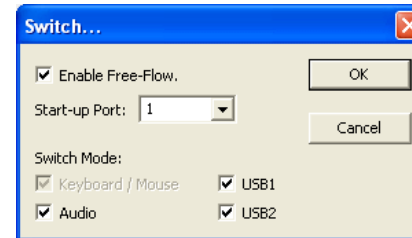

Enable (Disable) Free-Flow

This option allows you to switch off the Free-Flow feature within the CCS4-USB switch. Located within **Configure > Switch...** menu item, untick the **Enable Free-Flow** checkbox and download the configuration the CCS4-USB switch to disable.

Start-up Port

Located within **Configure > Switch...** menu item (see above image), this option allows you to determine which port should be enabled whenever the CCS4-USB switch is first powered on.

Switch Mode

Located within **Configure > Switch...** menu item (see above image), these check boxes allow you to determine which peripherals should be switched whenever the channel is changed by the Free-Flow method. The switching of peripherals via the other methods of channels selection (e.g. the front panel, hotkeys, mouse buttons, etc.) remain unaffected by these settings. By default, the Keyboard/Mouse and Audio are selected.

Performing upgrades (Windows only)

The CCS4-USB switch is fully upgradeable via flash upgrade. Such upgrades require a Windows-based computer system to be linked via the **OPTIONS** port.

Items required to perform an upgrade

- The supplied flash upgrade cable (VSC40).
- A Windows-based computer with an RS232 serial port.
- The latest version of the KVM Firmware Uploader and firmware files for the CCS4-USB switch - available from the *Technical Support > Updates* section of the Adder Technology website (www.adder.com).

To use the KVM Firmware Uploader utility

1 - Obtain and run the KVM Firmware Uploader.

Download the latest CCS4-USB switch KVM Firmware Uploader from the Adder Technology website and install it on a Windows-based upgrade computer that will be connected to the CCS4-USB switch. The files are supplied as a compressed ZIP file. Decompress the ZIP file with an appropriate tool such as WinZip (www.winzip.com) and copy all contained files to the same folder on the upgrade computer.

2 - Power off the CCS4-USB switch

Remove the power supply plug from the rear panel of the switch.

3 - Connect the upgrade computer to the CCS4-USB switch

Connect the supplied flash upgrade cable between the serial port of the Windows-based computer and the **OPTIONS** port on the rear panel of the switch.

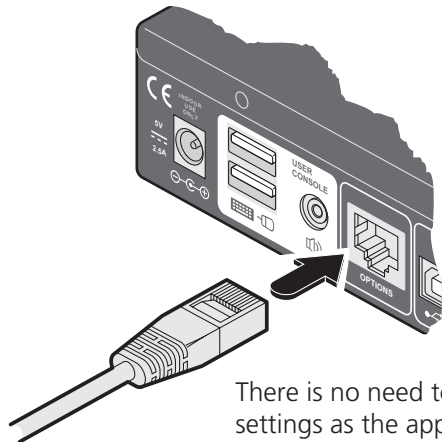

There is no need to adjust the computer's serial port settings as the application will do this automatically.

4 - Invoke upgrade mode

While powering on or when already powered: Press and hold the **COMPUTER** and **MODE** buttons (for up to ten seconds) until the numeric indicator shows '**U**'.

5 - Run the KVM Firmware Uploader utility

From that folder, select the KVMUploader icon to run the upgrade utility. The KVM Firmware Uploader dialog will be displayed:

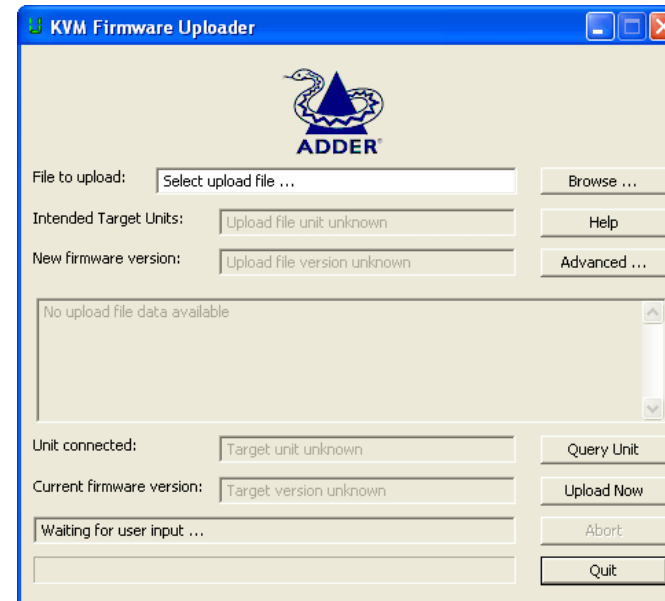

6 - Query the CCS4-USB switch

Click the *Query Unit* button to confirm that communication is possible with the CCS4-USB switch and to establish its firmware details. If successful, the 'Unit connected' field should show the name of the CCS4-USB switch and the current firmware will also be listed.

If the application cannot contact the CCS4-USB switch, re-check the connection cable and click the *Advanced...* button to check that the correct serial port is being used. Change the serial port within the *Advanced...* section, if necessary.

continued



WELCOME

INSTALLATION

CONFIGURATION

OPERATION

FURTHER INFORMATION

7 - Select the upgrade file to be used

From the main KVM Firmware Uploader dialog, click the *Browse...* button and select the upgrade file:

CCS4U_xxx.txt

where xxx is the firmware version.

The upgrade file details will be displayed within the dialog.

IMPORTANT: Check that the 'Intended Target Units' field matches the 'Unit Connected' field. If these fields do not match then you may have an incorrect upgrade file, check with Adder Technology Ltd before proceeding. Check also that the 'New firmware version' is greater than the 'Current firmware version'.

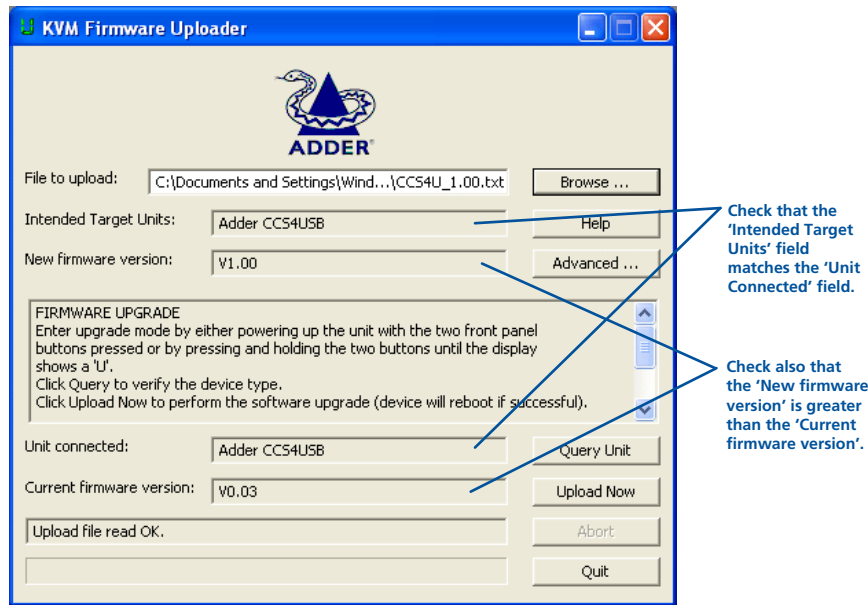

Issues to consider when performing flash upgrades

The upgrade program rewrites the internal firmware code. If the upgrade process is interrupted then the switch will have invalid code and will not be able to operate. It is therefore good practice to ensure that the upgrade process is always fully completed. A partial or failed upgrade may be rectified by performing another upgrade.

WARNING: Running faulty or partially upgraded code may have unpredictable results and may damage your CCS4-USB switch or computing equipment.

8 - Commence the upgrade

To begin the upgrade process, click the *Upload Now* button and confirm when requested. The progress will be shown within the dialog. Should you decide not to continue with the upload at any stage, click the *Abort* button; response to this is usually immediate, however, during an erase command, the upload will not be aborted until the erase is complete (this may take a few seconds).

9 - Cycle the power

Disconnect the power and remove the upgrade cable. When the power is re-applied the CCS4-USB switch will operate using the new firmware.

Operation

Selecting a computer

There are five ways to switch the common peripherals to specific computer channels:

- Using the innovative Free-Flow automatic switching utility 
- Using the control panel 
- [Using hotkeys](#)
- [Using mouse button presses](#)
- [Using the optional RC4 remote control](#)

To select a computer using the Free-Flow utility

Once configured, Free-Flow allows you to change channels merely by moving the mouse to edge of one screen towards the next screen. As the mouse pointer reaches the edge it will cause the channel to automatically change and will jump to the next screen.

Notes:

Free-Flow cannot be enabled until a layout has been configured and downloaded to the CCS4-USB switch - see [Free-Flow configuration](#).

The mouse will not flow across the screens while any mouse buttons are pressed down - this prevents undesired behaviour when dragging windows around or group-selecting items.

You can determine which peripherals will be switched by Free-Flow independently of those that would be switched with any other method. See **Switch Mode** within the [Switch... settings](#) section.

You can continue to use any of the other channel switching methods while Free-Flow is enabled.

The four upper indicators on the CCS4-USB display panel will scroll across every few seconds to show that Free-Flow is enabled. See [What is Free-Flow?](#) for an introduction to the utility or [Free-Flow configuration](#) for more details about how to prepare it for operation.

You can temporarily disable (and re-enable) Free-Flow using hotkey presses:

- Simultaneously press and hold **Ctrl** and **Alt**, then press **F**

To select a computer using the control panel

The control panel allows you to determine how the various peripherals are switched to one or more computer channels.

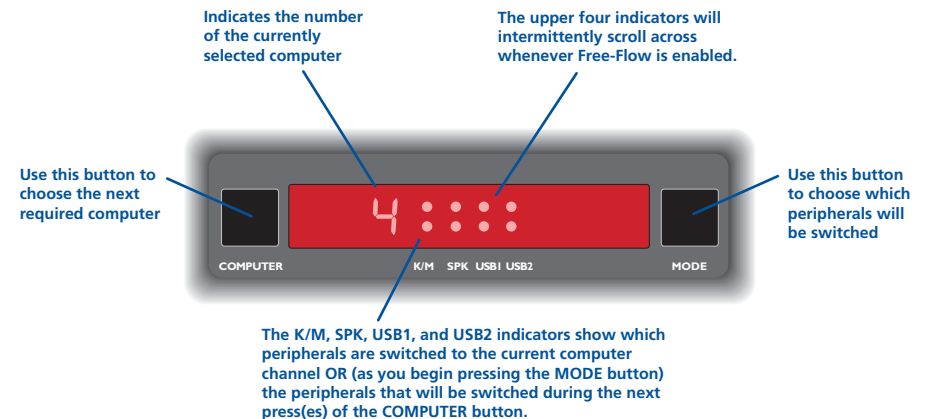

- 1 Optional: If you need to selectively switch some of your peripherals, press the MODE button repeatedly to change the switching mode:

	K/M	SPK	USB1	USB2	
MODE →	●	●	●	●	Will switch all peripherals together
MODE →	●	●	●	●	Will switch keyboard, mouse and speakers
MODE →	●	●	●	●	Will switch only the keyboard and mouse
MODE →	●	●	●	●	Will switch only the speakers
MODE →	●	●	●	●	Will switch only USB peripheral 1
MODE →	●	●	●	●	Will switch only USB peripheral 2

Notes:

If an indicator flashes, it signifies that the respective peripheral is currently switched to another computer channel.

The peripherals to be switched using the Free-Flow method are set independently

- 2 Press the COMPUTER button repeatedly to select the required computer channel.

To select a computer using hotkeys

Using hotkey combinations, you can quickly switch the keyboard and mouse, speakers and USB peripherals to any computer channel.

There are two main ways to use hotkeys: *Standard* and *Additional*.

Standard hotkey press combinations

The standard hotkey press combinations allow you to change channels with the minimum of keypresses:

- 1 Simultaneously press and hold **Ctrl** and **Alt** (or other hotkeys, if altered).
- 2 While still holding **Ctrl** and **Alt**, press the number key of the required channel address (or the TAB key), then release all of the keys.

Note: The numbers on your keyboard's numeric keypad are not valid, use only the numeral keys above the QWERTY section.

The ports (K/M, audio and/or USB) that are switched using this method depend upon the switching mode that is currently set using the [control panel buttons](#).

The range of standard hotkey combinations are as follows:

*Note: If your hotkeys have been changed, substitute them for **Ctrl** and **Alt** in the examples given here.*

Ctrl Alt 1	Selects channel 1
Ctrl Alt 2	Selects channel 2
Ctrl Alt 3	Selects channel 3
Ctrl Alt 4	Selects channel 4
Ctrl Alt 0	Isolates the user console from all channels
Ctrl Alt Tab	Selects the next channel (see note ⇔)

What are hotkeys?

The **Ctrl** and **Alt** keys when pressed in combination are called 'hotkeys' and they signal to the CCS4-USB switch that you wish to control it, rather than the computer. However, if these particular hotkeys clash with another device or program, you can change them to a different combination within the [Configuration](#) menu.

Additional hotkey press combinations

In addition to the standard hotkey press combinations (shown left), you can also add additional keypresses in order to determine which peripherals are switched:

- 1 Simultaneously press and hold **Ctrl** and **Alt**.
- 2 Press and release a command key:
 - A** to switch all peripherals
 - K** to switch only the keyboard and mouse
 - S** to switch only the speakers
 - U** to switch only USB1 and USB2
- 3 Press and release the required channel number (**1** to **4** using only the keys above the QWERTY section).
- 4 Release **Ctrl** and **Alt**.

The appropriate peripherals will change to the chosen channel.

Note: Regardless of which peripherals were switched, the front panel indicators will continue to show the switching mode that was last determined using the front panel controls.

Disabling/Enabling Free-Flow

Once Free-Flow is in operation, you can temporarily disable (and re-enable) it:

- Simultaneously press and hold **Ctrl** and **Alt**, then press **F**

Choosing which computers are accessed when using hot keys + tab

The computer channels that are visited when you use the hot keys + tab (or mouse buttons) are determined by a setting within the Configuration menu:

- 1 Enter the [Configuration](#) menu.
- 2 Press **U** and then press either:
 - 7** to choose **Cycle all ports**, or
 - 8** to choose **Cycle only active ports**
- 3 Press **Enter** to accept the setting and return to the main menu section.
- 4 Press **E** and then **Enter** to exit the menu and save changes.

To select a computer using the mouse buttons

Using the mouse buttons, you can quickly switch the keyboard and mouse, speakers and/or USB peripherals to any computer channel.

Note: These procedures work only with three-button or IntelliMouse devices and only if the 'Mouse Switching' option has been enabled.

To select a computer using the mouse buttons

- 1 Hold down the middle button (or scroll wheel) of the mouse.
- 2 Click the left mouse button to increment the channel number or click the right mouse button to decrement the channel. When the correct channel is reached, release the middle button.

When using this method of switching:

- The computer channels that are visited depend upon the configuration menu setting (see note ⇔).
- The ports (K/M, audio and/or USB) that are switched using this method depend upon the switching mode that is currently set using the [control panel buttons](#).

Choosing which computers are accessed when using mouse buttons

The computer channels that are visited when you use the mouse buttons (or hotkeys + tab) are determined by a setting within the Configuration menu:

- 1 Enter the [Configuration](#) menu.
- 2 Press **U** and then press either:
 - 7** to choose **Cycle all ports**, or
 - 8** to choose **Cycle only active ports**
- 3 Press **Enter** to accept the setting and return to the main menu section.
- 4 Press **E** and then **Enter** to exit the menu and save changes.

To lock access to the computers

When privacy is required, you can lock access to the connected computers via the switch.

To lock the switch

- 1 Simultaneously press and hold **Ctrl** and **Alt** (or other hotkeys, if altered).
- 2 While still holding **Ctrl** and **Alt**, press **L**.
The display will show **P** (providing a valid password has been previously set). You will not be able to access any computers until the password is correctly entered.

To unlock the switch

- When prompted, enter the correct password and press **Enter**.

To set a new password

- 1 Enter the **Configuration** menu.
- 2 Press **P** and then **Enter**. The display will show **:**
- 3 Enter a new password and then **Enter**.
The password is not case sensitive and can be any combination of key strokes, including the function keys, but excluding the Num Lock, Caps Lock, Scroll Lock and **Enter** keys. If your keyboard has special media keys, these also cannot be used as part of the password.
When you have typed in your password, press **Enter** to store it. Don't worry if you type the password incorrectly, you can always re-enter configure mode and set the password again.
- 4 Press **E** and then **Enter** to exit the menu and save changes.

To cancel the password

- 1 Enter the **Configuration** menu.
- 2 Press **P** and then **Enter**. The display will show **:**
- 3 Press **Enter** to remove the existing password.
- 4 Press **E** and then **Enter** to exit the menu and save changes.

If you forget the password

To clear an existing password: Connect the **OPTIONS** port of the switch to the serial port of a computer and transmit the text **clrpwd** to the switch.

Further information

This chapter contains a variety of information, including the following:

- Getting assistance - see right
- [Appendix 1 – Cable pin-outs](#)
- [Safety information](#)
- [Warranty](#)
- [Radio frequency energy statements](#)

Getting assistance

If you are still experiencing problems after checking the information contained within this guide, then we provide a number of other solutions:

- **Online solutions and updates** – www.adder.com/support
Check the Support section of the adder.com website for the latest solutions and firmware updates.
- **Adder Forum** – forum.adder.com
Use our forum to access FAQs and discussions.
- **Technical support** – www.adder.com/contact-support-form
For technical support, use the contact form in the Support section of the adder.com website - your regional office will then get in contact with you.



WELCOME

INSTALLATION

CONFIGURATION

OPERATION

FURTHER
INFORMATION

Appendix 1 – Cable pin-outs

The OPTIONS port uses a 10p10c socket which can accommodate both 10p10c connectors as well as the much more common 8p8c connectors, which are used on Ethernet leads and patch cables. The pin-outs are listed in this section for both types of connector.

Serial remote control and flash upgrade cable (8p8c)

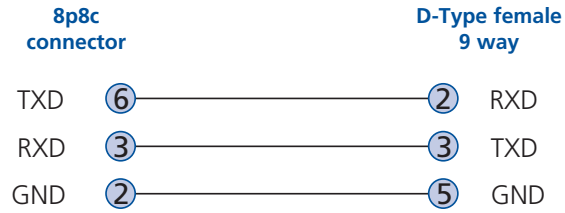

Serial remote control and flash upgrade cable (10p10c)

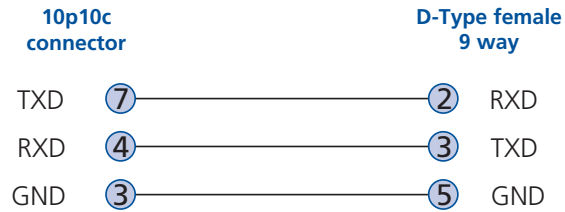

Note: You can also use the supplied flash upgrade cable (part number VSC40).

Safety information

- For use in dry, oil free indoor environments only.
- Not suitable for use in hazardous or explosive environments or next to highly flammable materials.
- Warning – the power adapter contains live parts.
- No user serviceable parts are contained within the power adapter - do not dismantle.
- Do not use the power adapter if the power adapter case becomes damaged, cracked or broken or if you suspect that it is not operating properly.
- Replace the power adapter with a manufacturer approved type only.
- If you use a power extension cable, make sure the total ampere rating of the devices plugged into the extension cable do not exceed the cable's ampere rating. Also, make sure that the total ampere rating of all the devices plugged into the wall outlet does not exceed the wall outlet's ampere rating.
- Do not attempt to service the CCS4-USB switch, the power adapter or the optional remote control yourself.
- The power adapter can get warm in operation – do not situate it in an enclosed space without any ventilation.
- The CCS4-USB switch does not provide ground isolation and should not be used for any applications that require ground isolation or galvanic isolation.
- When using the power adapter, use only with a grounded outlet. When using a backup power supply (UPS), power the computers, the monitors and the CCS4-USB from the same supply.

Warranty

Adder Technology Ltd warrants that this product shall be free from defects in workmanship and materials for a period of two years from the date of original purchase. If the product should fail to operate correctly in normal use during the warranty period, Adder will replace or repair it free of charge. No liability can be accepted for damage due to misuse or circumstances outside Adder's control. Also Adder will not be responsible for any loss, damage or injury arising directly or indirectly from the use of this product. Adder's total liability under the terms of this warranty shall in all circumstances be limited to the replacement value of this product. If any difficulty is experienced in the installation or use of this product that you are unable to resolve, please contact your supplier.



WELCOME

INSTALLATION

CONFIGURATION

OPERATION

FURTHER
INFORMATION

Radio Frequency Energy

All interface cables used with this equipment must be shielded in order to maintain compliance with radio frequency energy emission regulations and ensure a suitably high level of immunity to electromagnetic disturbances.

European EMC directive 2004/108/EC

This equipment has been tested and found to comply with the limits for a class A computing device in accordance with the specifications in the European standard EN55022. These limits are designed to provide reasonable protection against harmful interference. This equipment generates, uses and can radiate radio frequency energy and if not installed and used in accordance with the instructions may cause harmful interference to radio or television reception. However, there is no guarantee that harmful interference will not occur in a particular installation. If this equipment does cause interference to radio or television reception, which can be determined by turning the equipment on and off, the user is encouraged to correct the interference with one or more of the following measures: (a) Reorient or relocate the receiving antenna. (b) Increase the separation between the equipment and the receiver. (c) Connect the equipment to an outlet on a circuit different from that to which the receiver is connected. (d) Consult the supplier or an experienced radio/TV technician for help.

FCC Compliance Statement (United States)

This equipment generates, uses and can radiate radio frequency energy and if not installed and used properly, that is, in strict accordance with the manufacturer's instructions, may cause interference to radio communication. It has been tested and found to comply with the limits for a class A computing device in accordance with the specifications in Subpart J of part 15 of FCC rules, which are designed to provide reasonable protection against such interference when the equipment is operated in a commercial environment. Operation of this equipment in a residential area may cause interference, in which case the user at his own expense will be required to take whatever measures may be necessary to correct the interference. Changes or modifications not expressly approved by the manufacturer could void the user's authority to operate the equipment.

Canadian Department of Communications RFI statement

This equipment does not exceed the class A limits for radio noise emissions from digital apparatus set out in the radio interference regulations of the Canadian Department of Communications.

Le présent appareil numérique n'émet pas de bruits radioélectriques dépassant les limites applicables aux appareils numériques de la classe A prescrites dans le règlement sur le brouillage radioélectriques publié par le ministère des Communications du Canada.



WELCOME

INSTALLATION

CONFIGURATION

OPERATION

FURTHER
INFORMATION

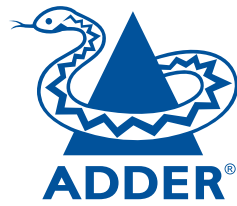

Web: www.adder.com

Contact: www.adder.com/contact-details

Support: forum.adder.com

WELCOME

INSTALLATION

CONFIGURATION

OPERATION

FURTHER
INFORMATION